

Camco

**THE ARISTOCRAT
OF THE
DRUM WORLD**

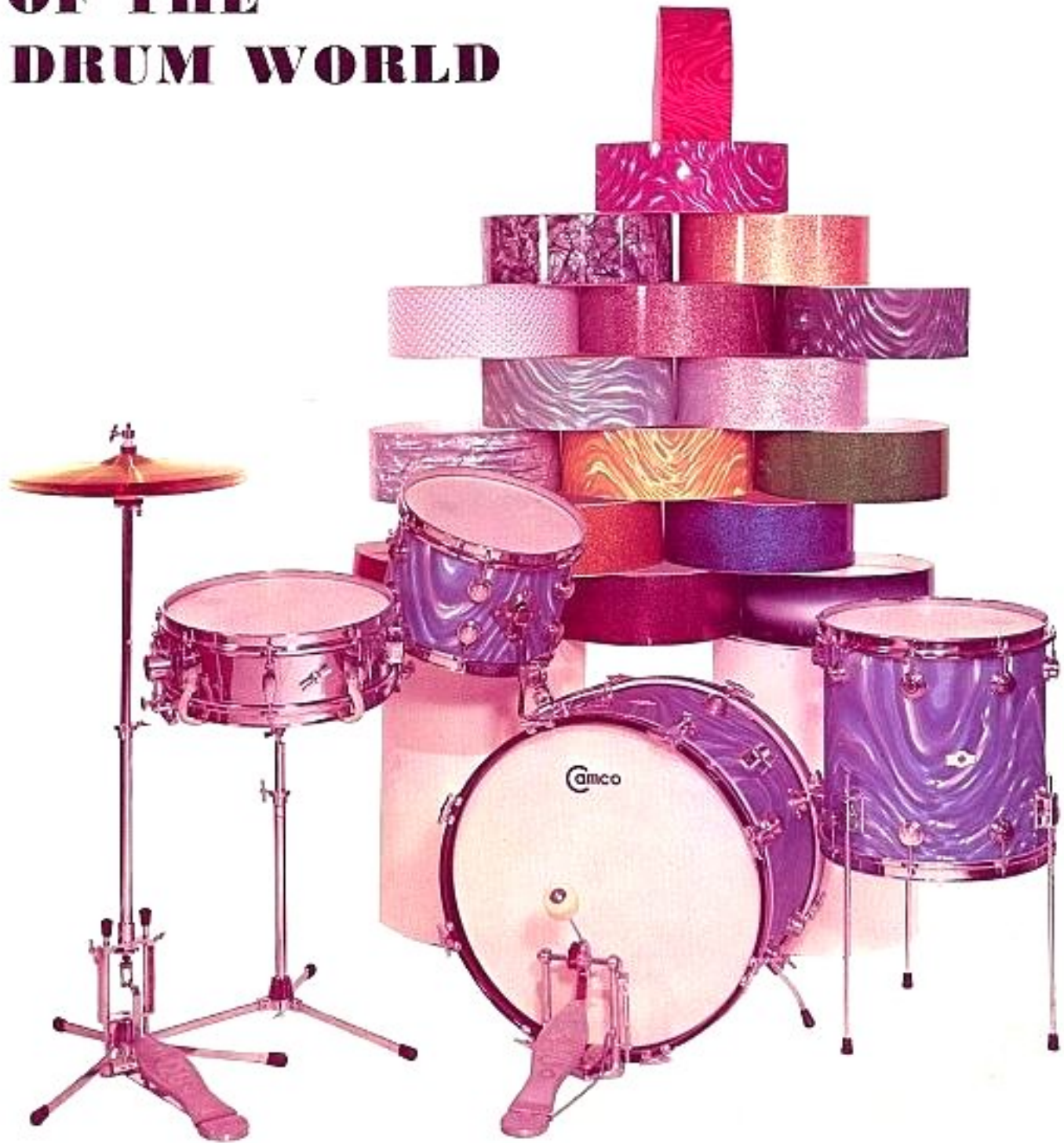

Camco "THE ARISTOCRAT" OF THE DRUM WORLD

DRUMS THAT ARE CRAFTED TO THE QUALITY OF FINE MUSICAL INSTRUMENTS

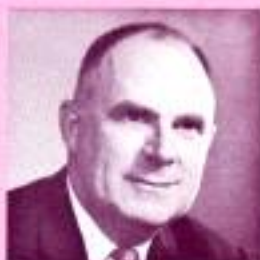

JOHN ROCHON
President



CLAIRE MAYER
Secretary



GEORGE LEWAN
Drum Division



CHUCK MOLINARI
Advisor

INDEX

Bass Drums	11	Drum Eye	14	Slings, Bell Lyra	29
Bass Drum Anchors	15	Drum Key	14	Slings, Drum	14
Bass Drum Mufflers	28	Drum Major Whistles	14	Snare Drums	7, 8, 9
Bass Drum Racks	14	Drum Outfits	3, 4, 5, 6	Snares	35
Bell Lyras	29	Drum Stands	18	Snare Drum Mufflers	28
Bell Lyra Stands	29	Gongs and Stands	20	Snare Strainers	33
Cases, Fibre	32	Greeko Cymbals	20	Song Whistles	27
Castanets	27	Guira	26	Spurs	15
Ching Ring	20	Heads, Plastic and Calfskin	25	Square Head Rods	34
Claves	26	Hi-Hat Stands	19	Sticks, Bass Drum	14, 31
Covers, Mackintosh	32	Hi-Stepper	14	Sticks, Scotch Bass	30
Cow Bells	26	Imitations	27	Sticks, Snare Drum	16
Cow Bell Holders	24, 28	Instruction Books	35	Sticks, Tenor Drum	30
Cymbals	20	Jingle Muffler	28	Sticks, Tympani	31
Finger Cymbals	20	Key Holders	14	Tambourines	27
Cymbal Clutches	19	Kits	9	Thrones	18
Cymbal Floor Stands	18	Latin Accessories	26, 27	Tom-Toms	10
Cymbal Holders, Band	24	Leg Rests	14	Tom-Tom Holders	24
Cymbal Holders, Bass Drum	23	Mallets	29, 30	Tom-Tom Legs	10
Cymbal Holders, Brush	24	Maracas	26	Tone Controls	28
Cymbal Holders, Hoop	23	Parade Drums	9, 12, 13	Triangles	28
Cymbal Holders, Shell	23	Pedals	22	Triangle, Holders	28
Cymbal Holders, Wood	21	Pedal Beater Balls	15	Whistles	14, 27
Cymbal Pad	21	Practice Pads	17, 18	Wire Brushes	17
Cymbal Straps	21	Practice Pad Stands	17	Wood Blocks	26
Cymbal Pouches	21	Replacement Parts	33-34	Wood Block Holders	24, 28
Cymbal Sizzlers	21	Slap Sticks	27	Wood Rattle	27
Cymbal Tilters	19	Sleigh Bells	27	Wood Whistles	27

TERMS

CAMCO PRODUCTS ARE SOLD THROUGH DEALERS IN OPEN TERRITORIES ONLY

All previous quotations cancelled. All prices are list, subject to change without notice and to the usual terms. F.O.B. shipping point. New accounts please submit three trade references and bank.

Substitutions permissible. Colors matched on non-cancellable, non-returnable basis. Plastic heads standard on all drums unless otherwise specified. All metal parts chrome plated. Heads and Cymbals not guaranteed.

Claims for losses, damages or pilferage must be made to the Transportation Company. Our responsibility ceases upon delivery to the Transportation Company. Shipments should be opened and examined immediately for loss or damage, either VISIBLE or CONCEALED.

Check all contents and save all cartons and packing material. Call your local agent at once for an inspection. Obtain a signed inspection report from him and file claim for loss or damage.

Camco DRUM COMPANY

9221 South Kilpatrick Avenue

Oaklawn, Illinois • Phone GA 3-2900



Camco THE ADVANCED "MODERNAIRE" OUTFIT



Here is the "Big Apple" of all drum outfits . . . designed for the drummer who is seeking the complete range of sounds—with true drum character in every beat—and with a full measure of modern styling and mechanical perfection. This set is for both large and small bands. It is right for the classics or for jazz. There is nothing finer to be had and nothing that will give greater playing satisfaction and eye appeal than the advanced "MODERNAIRE."

with "ARISTOCRAT" Drums

- Double Flange—
Double Edge
Counter Hoops
- 4-Ply Electronically
Bonded Shells
- All Metal Parts
AAA Chromium Plated

"MODERNAIRE" OUTFIT

		Lacquer	Pearl
450	5x14 Aristocrat Snare Drum.....	\$77.00	\$ 87.00
1122	14x22 Aristocrat Bass Drum.....	97.50	127.50
1412	2-8x12 Aristocrat Tom-Toms.....	115.00	130.00
1416	16x16 Aristocrat Floor Tom-Tom..	70.00	85.00
1480	Camco Disappearing Spurs.....	6.50	6.50
5000	Camco Deluxe Foot Pedal.....	22.50	22.50
600	Camco Flush Base Drum Stand...	12.75	12.75
800	Camco Flush Base Hi-Hat Pedal...	20.00	20.00
1435-CD	Double Tom-Tom Holder.....	18.00	18.00
700	2-Camco Flush Base Cymbal Stands	21.50	21.50
4410	1-set Camco Tom-Tom Legs.....	9.00	9.00
1070	1-pair Wire Brushes, Rubber Handle	1.75	1.75
1430	Felt Muffler Strip.....	1.00	1.00
	1-pair Camco Drum Sticks.....	1.20	1.20
	TOTAL VALUE:	\$473.70	\$543.70
	SPECIAL PRICE:	\$450.50	\$516.50

Cymbals are not included

Moire Covering Extra

\$ 30.00

Camco THE "CASINO" ARISTOCRAT OUTFIT



With "ARISTOCRAT" Drums

- Double Flange—Double Edge Counter Hoops
- 6-Ply Electronically Bonded Shells
- All Metal Parts AAA Chromium Plated

		Lacquer	Pearl			Lacquer	Pearl
450	5x14 Casino Aristocrat Snare Drum	\$77.00	\$87.00	5000	Camco Deluxe Pedal	\$22.50	\$22.50
1120	14x20 Aristocrat Bass Drum	94.00	124.00	800	Camco Flush Base Hi-Hat Pedal	20.00	20.00
1412	8x12 Aristocrat Tom-Tom	57.50	65.00	600	Camco Flush Base Drum Stand	12.80	12.80
1414	Aristocrat Floor Tom-Tom	65.00	80.00	1103	Cow Bell	2.10	2.10
1480	Camco Disappearing Spurs	6.50	6.50	1422	Cow Bell Holder	3.00	3.00
1435-C	Tom-Tom Holder	12.75	12.75	1070	Wire Brushes R.C. Loop End	1.75	1.75
4410	Camco Tom-Tom Legs	9.00	9.00		1-pair Drum Sticks	1.20	1.20
1450	Cymbal Holder Shell Mount	7.50	7.50	1430	Felt Muffler Strip	1.00	1.00

Cymbals Not Included—For a 14x22 Bass Drum Add \$5.50

Moire Covering Extra \$ 30.00

TOTAL VALUE: \$393.60 \$456.10

SPECIAL PRICE: \$373.90 \$433.30

ARISTOCRAT SWINGER OUTFIT



		Lacquer	Pearl
450	Aristocrat 5x14 Snare Drum	\$77.00	\$ 87.00
1120	Aristocrat 14x20 Bass Drum	94.00	124.00
1412	Aristocrat 8x12 Tom-Tom	57.50	65.00
1480	Camco Disappearing Spurs	6.50	6.50
1435-C	Tom-Tom Holder	12.75	12.75
1450	Cymbal Holder Shell Mount	7.50	7.50
5000	Camco Deluxe Pedal	22.50	22.50
800	Camco Flush Base Hi-Hat Pedal	20.00	20.00
600	Camco Flush Base Drum Stand	12.80	12.80
1070	Wire Brushes R.C. Loop End	1.75	1.75
	1-pair Drum Sticks	1.20	1.20
1430	Felt Muffler Strip	1.00	1.00

TOTAL VALUE: \$314.50 \$362.00

SPECIAL PRICE: \$298.70 \$343.90

Moire Covering Extra \$ 18.00

Cymbals Not Included

Camco "GEMINI" OUTFIT



		Lacquer	Pearl				
450	1-5x14 Snare Drum	\$ 77.00	\$ 87.00	5000	2-Cameo Deluxe Pedals	45.00	45.00
1120	2-14x20 Bass Drums	188.00	248.00	900	1-Direct Pull Hi-Hat Stand	29.50	29.50
1412	2-8x12 Tom-Toms	115.00	130.00	700	2-Floor Cymbal Stands	21.50	21.50
1414	1-14x14 Floor Tom-Tom	65.00	80.00	600	Flush Base Drum Stand	12.80	12.80
1480	2 pair Chrome Spurs	13.00	13.00	1070	1-pair Wire Brushes	1.75	1.75
950	1-Double Tom-Tom Stand	14.00	14.00		1-pair Drum Sticks	1.20	1.20
4410	1-set Tom-Tom Legs	9.00	9.00	1430	2-Felt Muffler Strips	2.00	2.00

TOTAL VALUE: \$594.75 \$694.75

SPECIAL PRICE: \$565.00 \$660.00

Cymbals Not Included Moire Covering Extra \$ 42.00



NEW "TUXEDO" OUTFIT

		Lacquer	Pearl
701	5x14 Snare Drum	\$ 69.50	\$ 79.50
2330	14x20 Bass Drum	87.00	117.00
3012	8x12 Tom-Tom	52.00	60.00
1480	Arch Disappearing Spurs	6.50	6.50
1435-C	Chrome Tom-Tom Holder	12.75	12.75
1450	Shell Mount Cymbal Holder	7.50	7.50
600	Flush Base Drum Stand	12.80	12.80
800	Flush Base Hi-Hat Stand	20.00	20.00
5000	Deluxe Foot Pedal	22.50	22.50
1070	Wire Brushes, Rubber Covered	1.75	1.75
1430	Felt Muffler Strip	1.00	1.00
	1-pair Drum Sticks	1.20	1.20

TOTAL VALUE: \$294.50 \$342.50

SPECIAL PRICE: \$279.80 \$325.40

Moire Covering Extra \$ 18.00

Cymbals Not Included

Camco "COMBO" OUTFIT



		Lacquers	Pearls
2320	14x20 Bass Drum.....	\$ 87.00	\$117.00
701-EL	5x14 Snare Drum	55.00	65.00
3012	8x12 Tom-Tom	52.00	60.00
1716-N	Snare Drum Stand	9.50	9.50
6000	Standard Camco Foot Pedal.....	16.75	16.75
1450	Shell Mount Cymbal Holder.....	7.50	7.50
1480	Disappearing Spurs	6.50	6.50
1435-N	Tom-Tom Holder	9.50	9.50
1070	1 pair Wire Brushes.....	1.75	1.75
	1 pair 7-A Drum Sticks.....	1.20	1.20
429-N	Cow Bell Holder	1.20	1.20
1101	3½" Cow Bell	1.50	1.50
1430	Felt Muffler Strip	1.00	1.00

TOTAL VALUE \$250.40 \$298.40

SPECIAL PRICE \$237.80 \$283.40

Moire Covering Extra — \$18.00

Cymbal not included

"ENTERTAINER" OUTFIT

		Lacquers	Pearls
2328	14x18 Bass Drum	\$ 84.00	\$111.00
701-EL	5x14 Snare Drum	55.00	65.00
1716-N	Snare Drum Stand	9.50	9.50
6000	Standard Camco Pedal	16.75	16.75
1440	Cymbal Holder	5.00	5.00
1705	Chrome Spurs	5.00	5.00
429-N	Cow Bell Holder	1.20	1.20
1101	3½" Cow Bell	1.50	1.50
	1-pair Drum Sticks	1.20	1.20
1070	Wire Brushes	1.75	1.75
1430	Felt Muffler Strip.....	1.00	1.00

TOTAL VALUE \$181.90 \$218.90

SPECIAL PRICE \$172.80 \$207.90

Moire Covering Extra — \$14.50

Cymbal not included



Choice of Lacquers or Pearls

Camco NO. 99 SUPER



NEW PARALLEL STRAINER

\$99.00

5x14
in Metal or
Choice of Pearls



FEATURES . . .

- Snare Contacts Head Even
- Choke Free Sound
- 20-Strand Snares
- Polished Chrome Shell
- Triple Flange Hoops
- Internal Tone Control
- Camco Key Holder
- Tone Control

99-M Super—Chrome Shell \$99.00
99-P Super—Choice of Pearl 99.00

TUXEDO METAL DRUM

- TRIPLE FLANGE HOOPS
- 20 STRAND SNARE
- CHROME SHELL
- TONE CONTROL
- KEY HOLDER
- 8 LUGS



No. 701-M 5x14 Snare Drum **\$85.00**

THE "ARISTOCRAT"

A great number of top ranking professionals declare the 5 x 14 size drum to be the best for those who do all-around work with different groups. The "ARISTOCRAT" 5 x 14 has both delicacy and volume and will withstand hard usage on the road. It is a "tailor-made" instrument of mechanical efficiency and modern styling . . . A wonderful easy-playing drum, with sounds that will please the perfectionist.



Tone Control
Choice of Calf or Plastic Heads
Photo Shows 5 x 14 in Sparkling Gold

ORCHESTRA

450-P	5x14 Choice of Pearls	87.00
450-L	5x14 Choice of Lacquers	77.00
450-M	5x14 Metal	87.00

CONCERT ARISTOCRAT

452-P	6½x14 Choice of Pearls	\$89.50
452-L	6½x14 Choice of Lacquers	79.50

6½" DRUMS HAVE DOUBLE ROW OF CASINGS

THE BAND "ARISTOCRAT"

This is a real "drummer's drum," with colorful, rich and penetrating sounds that make it the very "tops" for large concert bands and orchestras. It is the correct size for producing great volume; yet it is so sensitive that it can be played down to a "whisper." Like all "ARISTOCRATS," it is very carefully made in every part—even to finishing the inside of the shell.

456-P	8x15 Choice of Pearls	\$92.50
456-L	8x15 Choice of Lacquers	82.50

Choice of Plastic or Calf Heads
Gut Snares—\$2.00 Extra

**ALL METAL PARTS
TRIPLE CHROME
PLATED**



Tone Control
All Metal Parts on All Drums Are
AAA Chrome Plated
Photo Shows 8 x 15 in Mahogany

STUDIO MODEL

701-EL	5x14 Lacquer or Mahogany . .	\$55.00
701-EP	In Pearl	65.00

8 Lug
Key Holder
Triple Flange Hoops



THE 'ORCHESTRA' TUXEDO

5x14 Snare Drum
Drum Shown in Blue Moire

701-P	In Pearls	\$79.50
701-L	In Lacquers	69.50
712-P	6½x14 Choice of Pearls....	\$81.50
712-L	6½x14 Choice of Lacquers ..	71.50

Tone Control and Key Holder Included
8 Streamline Lugs



No. 910-D DELUXE DRUM KIT

No. 910-D DELUXE DRUM KIT

701-EP	5x14 Pearl Snare Drum.....	\$65.00
	Blue Deluxe Case.....	15.80
1100	Round Practice Pad.....	3.00
600	Flush Base Drum Stand.....	12.80
	1 Pair 2-B Drum Sticks.....	1.20

TOTAL VALUE: \$97.80

SPECIAL PRICE: 92.00

No. 910 STANDARD DRUM KIT

Same as above except 701-EL Snare Drum and 1716-N Drum Stand.

TOTAL VALUE: \$84.50

SPECIAL PRICE: 76.00



10" x 14" PARADE DRUM

515-L In Lacquer
or Mahogany...\$59.00

515-P In Pearl .. 69.00

Sticks, Sling and Key Holder
Included.

Choice of Wood or Metal
hoop. 8 Rod.



Photo Shows
16x16 in
3D Moire
and 4410
Tom-Tom Legs



Photo Shows
9x13 in
White Pearl

"ARISTOCRAT" TOM-TOMS

All "ARISTOCRAT" Tom-Toms have our exclusive Double Edge-Double Flange Hoops and "turret" casings with self-aligning rods. All shells are 4-Ply electronically bonded, with reinforcing hoops. Shells are finished on the inside to prevent moisture penetration. Tone Control included.

		Lacquer	Pearl
1412	8x12	\$57.50	\$65.00
1413	9x13	60.00	67.50
1414	14x14	65.00	80.00
1416	16x16	70.00	85.00

CAMCO TOM-TOM LEGS

There are 12 ring notches turned into each of the chrome plated legs. Wing screws seat themselves into the notches. Legs cannot slip.

4410	3 Legs and Brackets.....	\$9.00
4411	1 Leg and Bracket.....	3.00

"TUXEDO" TOM-TOMS

		Lacquer	Pearl
3012	8x12	\$52.00	\$60.00
3013	9x13	55.00	62.50
3014	14x14	60.00	75.00
3016	16x16	65.00	80.00

CAMCO LARGE SPREAD TOM-TOM LEGS

The fine notches turned into the legs provide ample height adjustment and positively prevent slipping under heavy beating. Note that legs flare outward.

4412	3 Legs and Brackets.....	\$10.50
4413	1 Leg and Bracket.....	3.50



Photo Shows
14x14 in
Blue Moire
and 4412
Wide Spread Legs



Camco

"ARISTOCRAT" BASS DRUMS

Drummers and leaders in both the school and professional fields must have the particular "sound style" that blends in with the musical character of their special organization. Jobbing drummers often have to alter the sounds for different groups. We are, therefore, building our bass drums to withstand the ally bonded shells, with reinforcing hoops. The steel double claw hooks are of thicker gauge and have a wider bearing surface than those on most drums. The finishes are top grade, including hand-rubbed lacquers. These are indeed rugged, beautiful drums that can be adjusted to sounds required on any job.

		Lacquer	Pearl
1118	14x18	\$ 88.00	\$119.00
1120	14x20	94.50	124.50
1122	14x22	97.50	127.50
1124	14x24	107.50	137.50

"TUXEDO" BASS DRUMS

		Lacquer	Pearl
2328	14x18	\$84.00	\$111.00
2330	14x20	87.00	117.00
2332	14x22	92.00	122.00
2334	14x24	102.00	132.00



Photo Shows 14x22 in White Pearl





Camco "PARADE QUEEN"

- CHROME
- 4-PLY SHELLS
- SNAP-IN KEY HOLDER
- STREAMLINE CASINGS
- SEPARATE TENSION
- INTERNAL TONE CONTROL

SNARE DRUMS complete with Sticks and Sling

713-L	10x14	Lacquer or Mahogany	\$62.50
713-P	10x14	Choice of Pearl	75.00
716-L	12x15	Lacquer or Mahogany	76.00
716-P	12x15	Choice of Pearl	85.50
718-L	12x16	Lacquer or Mahogany	80.50
718-P	12x16	Choice of Pearl	90.00

TENOR DRUMS complete with Tenor Sticks and Sling

720-L	10x14	Lacquer or Mahogany	\$62.50
720-P	10x14	Choice of Pearl	75.00
722-L	12x15	Lacquer or Mahogany	76.00
722-P	12x15	Choice of Pearl	85.50
724-L	12x16	Lacquer or Mahogany	80.50
724-P	12x16	Choice of Pearl	90.00

SCOTCH BASS DRUMS complete with Slings and Beaters

3018-L	8x24	Lacquer or Mahogany	\$107.00
3018-P	8x24	Choice of Pearl	127.00
3020-L	10x24	Lacquer or Mahogany	107.00
3020-P	10x24	Choice of Pearl	127.00
3022-L	8x28	Lacquer or Mahogany	116.00
3022-P	8x28	Choice of Pearl	136.00
3024-L	10x28	Lacquer or Mahogany	116.00
3024-P	10x28	Choice of Pearl	136.00



*St. Joseph Military Academy
La Grange, Ill.*



Camco "PARADE MASTERS"

- CHROME
- 4-PLY SHELLS
- SNAP IN KEY HOLDER
- DELUXE STRAINER
- INTERNAL TONE CONTROL
- SEPARATE TENSION

PARADE MASTER SNARE DRUM Complete with Drum Sticks and Slings

		Lacquer	Pearl
458	10x14	\$72.50	\$84.50
460	12x15	85.00	97.50
462	12x16	86.50	98.50

PARADE MASTER TENOR DRUMS Complete with Beaters and Slings

		Lacquer	Pearl
464	10x14	\$72.50	\$84.50
466	12x15	85.00	97.50
468	12x16	86.50	98.50

PARADE MASTER SCOTCH BASS DRUMS Complete with Slings and Beaters

		Lacquer	Pearl
1145	8x24	\$112.00	\$132.00
1146	10x24	112.00	132.00
1147	8x28	121.00	141.00
1148	10x28	121.00	141.00



Long Island Sunrisers

For inlaid hoops on lacquer drums add \$5.00
 Plastic heads furnished unless other specified
 Gut Snares \$2.00 Extra



1200

BASS DRUM RACK

Over 1,000 high school, college and professional bass drummers are now using this—the top prize winner of all bass drum racks. Many have voluntarily stated that it is the strongest and best looking rack they have ever seen. Made of 1" diameter steel tubing instead of the usual 3/4" size. All chrome plated. It also opens wider and will accommodate the largest drums.

1200 Chrome \$21.00

SOLID WOOD BASS DRUM BEATERS

Solid rock maple. Natural lacquer finish. Usually used in pairs for the loud rudimental beats on parade. 12 1/2" Overall.

1048 Each \$2.50



1048

ACME DRUM MAJOR WHISTLES

All Metal—Easy Blow and Very Loud.

23 Small \$1.35

26 Large 1.65



23
26



No. 114



355

KEY HOLDER

Mounts in Shell — Always handy.

No. 114 \$1.00

PARADE DRUM EYE FOR SLING SNAP HOOK

Fits under square head rod.

355 Chrome 40¢

356 Bass Drum Hook \$1.00

WEB DRUM SLINGS

2" stout webbing. Fine Hardware.

SNARE DRUM

4447 White \$2.30

BASS DRUM

4453 White \$4.30

HI-STEPPER

4452 \$29.50 B



4447



4453



HI-STEPPER

4452 \$29.50 B

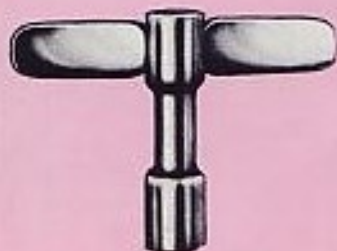

CAMCO DRUM KEY

1275 50¢

- Extra Heavy
- Extra Strong



NEW SPEED KEY

1280 \$1.50



PARADE LEG REST

Self-aligning adjustment. Keeps drum from swaying.

4434 Nickel \$4.80

4437 Chrome 6.75

DISAPPEARING SPURS

Shell Mount. Rubber Tips included. The square rods are arched and point straight to the floor. They slide in a square notch in the round housing—cannot turn. More floor spread than others.

1480 Pair, Chrome\$6.50

DISAPPEARING SPURS

Shell Mount. round steel rods slide in and out of bass drum shell. Can be used with either rubber or pointed tip.

1705 Pair, Chrome\$5.00

REGULATION SPURS

Hoop Mount. Equipped with 3½" spikes. Often used as extras for additional assurance against creeping on uneven floors.

1542 Pair, Nickel Only\$1.40

BASS DRUM ANCHOR

Hoop Mount. Hoop clamp with two reversible spurs. Can use either steel points or rubber tips.

1601 Chrome\$5.50

1602 Nickel 4.50

STICK-FAST SPUR ANCHORS

For all Model Spurs. Spurs fit into metal tubes which swivel in rubber cone bases. The sponge rubber floor grips will not creep.

1544 Pair\$4.90

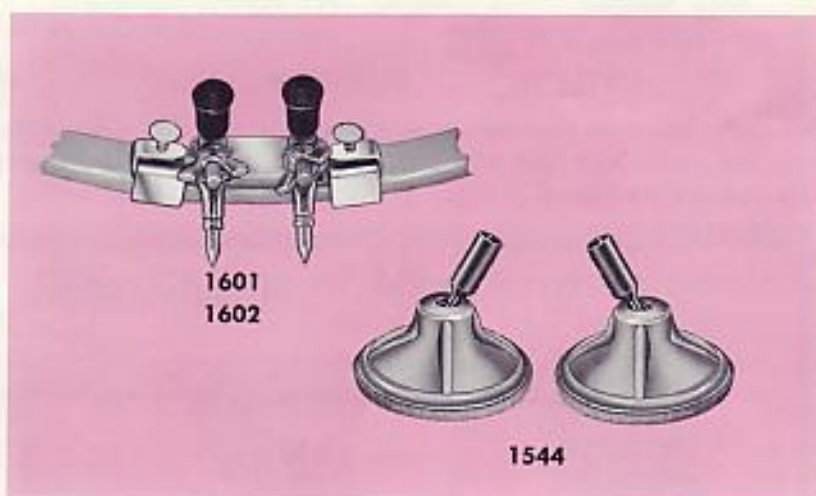
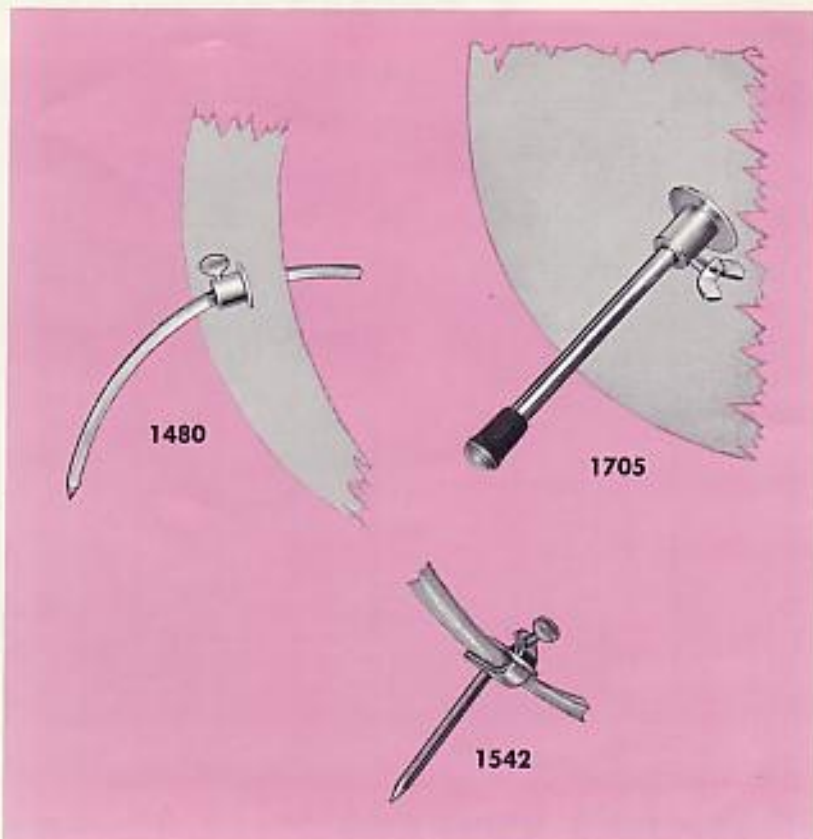

PEDAL BEATER BALLS AND RODS FOR ALL SOUNDS



Camco HICKORY DRUM STICKS



PEE WEE 7-A 0-B 1-A

JAZZ MODELS

Extra light weight

15" 15½" 16¼" 17"

2-A 3-A 5-A 6-A

DANCE AND SCHOOL MODELS

Light weight

15¾" 15½" 16" 15"

18 1-B 2-B 5-B

CONCERT MODELS

Medium weight

15½" 16½" 15¾" 16"

1-S 2-S 3-S

PARADE MODELS

Heavy weight

17" 17" 17½"

We invite drummers to compare our sticks with others. It will readily be noticed that these are "ultra" models. Two new extra operations have been added that have not been heretofore employed. The thoroughly dried hickory is the best obtainable and our workmanship shows in every stick. \$1.20 Pair.

NYLON TIP STICKS \$1.75

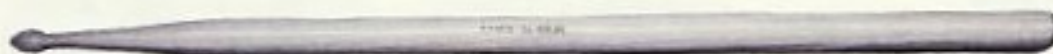

5-A Nylon

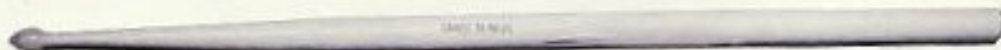

7-A Nylon

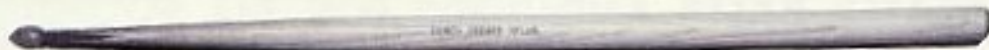

Pee Wee Nylon

PERSONALIZED HICKORY DRUM STICKS \$1.20

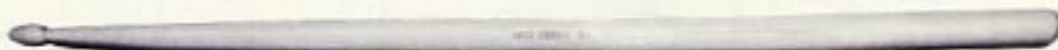

8-A Nick Ceroli

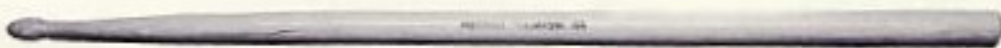

10-A Marshall
Thompson

Camco PRACTICE PADS

Gum Rubber on all Pads . . . Rubber Non-slip Feet . . . Red Glossy Enamel Finish

The "PROFESSIONAL" 9"x7"
1210 — \$4.50



The "STANDARD" 8"x7"
1215 — \$2.50



The "HEAVY DUTY" 9"x7"
1212 — \$4.50



The 6" RUBBER DISC
1230 — \$1.50



PRACTICE PAD

Has 6" Round Live Rubber Pad in Center. Protects Head in Case.

1100-14 for 14" DRUM

1100-15 for 15" DRUM

PRICE \$3.00

PRACTICE PAD STAND

1160—Stand only \$7.50

WALBERG WIRE BRUSHES "The Choice of Most Professionals"



Rubber Covered Handles
Loop Ends
1070
Pair — \$1.75



Rubber Covered Handles
Ball Ends
1072
Pair — \$1.85



Plain Aluminum Handles
Loop Ends
1074
Pair — \$1.50



Plain Aluminum Handles
Ball Ends
1076
Pair — \$1.75

CAMCO DELUXE CYMBAL STAND

Tilter included. Modern and very practical cymbal stand. Light weight—Rigid, too. Has wide-spread folding steel legs. Extends to 48".

700 Chrome Only — \$10.75



Cymbal not included



"CAMCO" FLUSH BASE DRUM STAND

Folding legs open flush to floor. Ratchet angle adjustment. Extendable for standing position. A high quality stand.

600 Chrome Only \$12.80



"MARVEL" FLUSH BASE DRUM STAND

The choice of many top name professionals . . . Sturdy. Rubber covered arms stop scratching.

1716-N Nickel \$ 9.50
1716-C Chrome 10.50

WALBERG CYMBAL STAND

Tilter included. Floor-flush folding legs—pressed steel and telescope tubing used in the construction of these stands.

1725 Nickel \$8.90

1726 Chrome \$9.90



Cymbal not included



CAMCO THRONE

Chrome Only. A steel screw through steel collar eliminates all possibilities of slipping.

Back rest \$2.25 extra.

9000 \$20.00



WALBERG THRONE

An old reliable rigid model — Padded seat. Back rest \$2.25 extra.

865-C Chrome ... \$19.75

865-N Nickel ... \$16.75

CAMCO PEDAL PRACTICE PAD

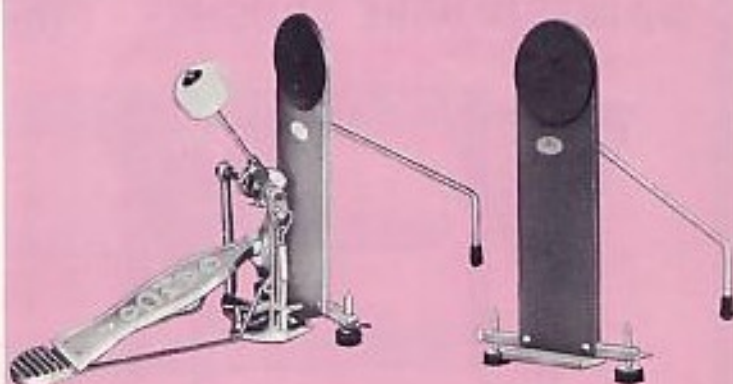

The importance of "foot work" in modern drumming equals that of stick technique. This practical pedal practice pad is the most advanced design made. It is well made of aluminum and steel parts, with a rubber disc beating surface. Takes up very little space. It will definitely improve "the beat."

1000 \$7.50

NEW CAMCO DIRECT PULL HI-HATS

Newest improved Hi Hat on the market in both tripod and flush base. All features shown by arrows are included in both Hi Hats.

500 HI-HAT

NEW IMPROVED CLUTCH

CYMBAL TILTING ADJUSTMENT

KNURL KNOB FOR SPRING ADJUSTMENT THAT CAN BE CHANGED AT WILL

LOCK SCREW FOR SPRING ADJUSTMENT KNOB

TWO HEAVY SPURS PREVENTS CREEPING

\$29.50

900 HI-HAT

NEW IMPROVED CLUTCH

CYMBAL TILTING ADJUSTMENT

KNURL KNOB FOR SPRING ADJUSTMENT THAT CAN BE CHANGED AT WILL

LOCK SCREW FOR SPRING ADJUSTMENT KNOB

TWO HEAVY SPURS PREVENTS CREEPING

\$29.50

All Chrome Plated.



THE FAMOUS "CAMCO" DELUXE HI-HAT

All of the desired qualities in Hi-Hat mechanism and playing ease are positively to be found in this exceptional model. The drummer can be so sure of "no bugs" that he can devote his full attention to cymbal sounds. Floor flush steel legs. Will not creep. Height adjusting.

800 Chrome Only \$20.00

Cymbal not included

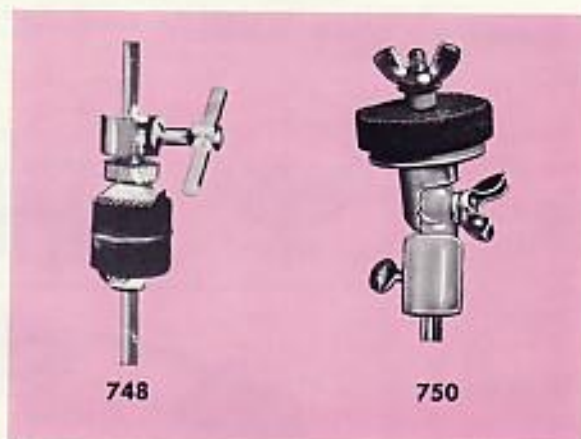

748 **750**

CAMCO HI-HAT CLUTCH

Simple and efficient.

748 **\$2.00**

CAMCO TILTER

Precision die cast, can't slip ratchet.

750 Chrome **\$2.00**

751 Nickel **\$1.80**

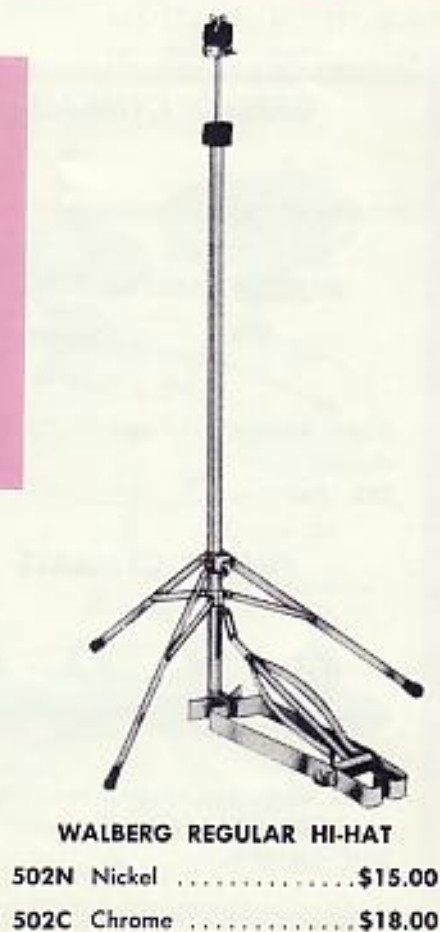

WALBERG REGULAR HI-HAT

502N Nickel **\$15.00**

502C Chrome **\$18.00**

AVEDIS ZILDJIAN CYMBALS

No other make of cymbal in the world has the wide endorsement of the Avedis Zildjian brand. They have that "something" in blare, brilliance and rich sounds that has never been equalled. That, of course, is the reason the great majority of professional drummers, as well as concert band and symphony orchestra conductors, choose them above all others both in this country and abroad. Avedis Zildjian and his sons—Bob and Armand—personally mix the secret alloy in a closely-guarded laboratory, just as it was formulated in 1623. After casting they are fired, hammered, shaped and tempered many times under high temperatures. All of this (and much more) plus great skill, assures the resonance and strength for which they are world-famous.

Please specify thickness desired.	12" 25.00 B
Extra Thin	13" 30.00 B
Thin	14" 33.00 B
Medium	15" 37.00 B
Medium Heavy	16" 40.00 B
Heavy	17" 45.00 B
	18" 50.00 B
	19" 55.00 B
	20" 60.00 B
	21" 65.00 B
	22" 70.00 B
	23" 75.00 B
	24" 80.00 B

We carry a large stock of all sounds . . . If you will describe the usage intended — and size of organization—we will be glad to make careful personal selections.

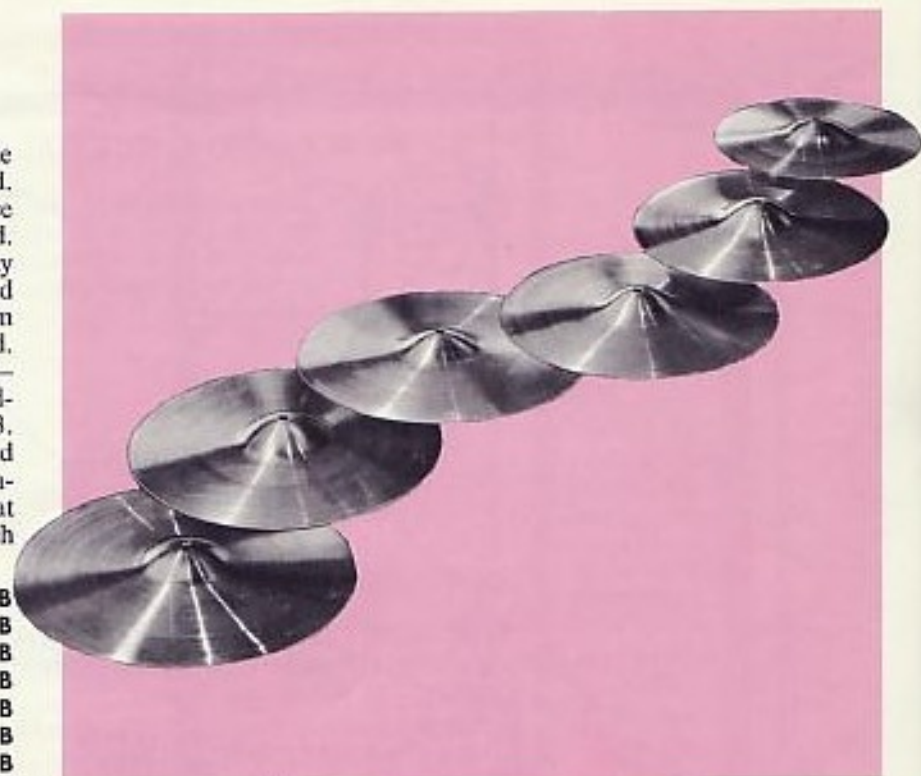

AVEDIS ZILDJIAN SIZZLE CYMBALS



Exactly the same cymbals as the Avedis Zildjian listed above, with sizzle rivets added. Use the same prices for the same size. Please state number of rivets desired.

GREEKO CYMBALS



Nickel Silver—3½" and 3¼" with hoop clamp.

222 Pair\$3.00

FINGER CYMBALS



Brass alloy. Highly polished. The tones are brilliant. 2½" diameter.

220 Set of 4.....\$3.50

CHING-RING



CHING-RING
7" STEEL SOUND-RESONATING RING
8 pr. QUALITY CHINGLES
ADJUSTABLE STEEL STRAP
FINE FINISH
\$9.95

CYMBAL STRAPS AND PADS

These cymbal straps and pads are cut with "a little extra" in length, width, and thickness—a little larger than most models. This gives longer wear and is a great assist in overcoming fatigue and the tempo problem. Made of top grain "pearl elk" leather. Note that we supply knot washers.

REGULATION

1051	Straps, Pair	\$1.80
1052	Pads, Pair	2.50

LAMB'S WOOL COVERED

1054	Straps, Pair	\$3.50
1056	Pads, Pair	6.00

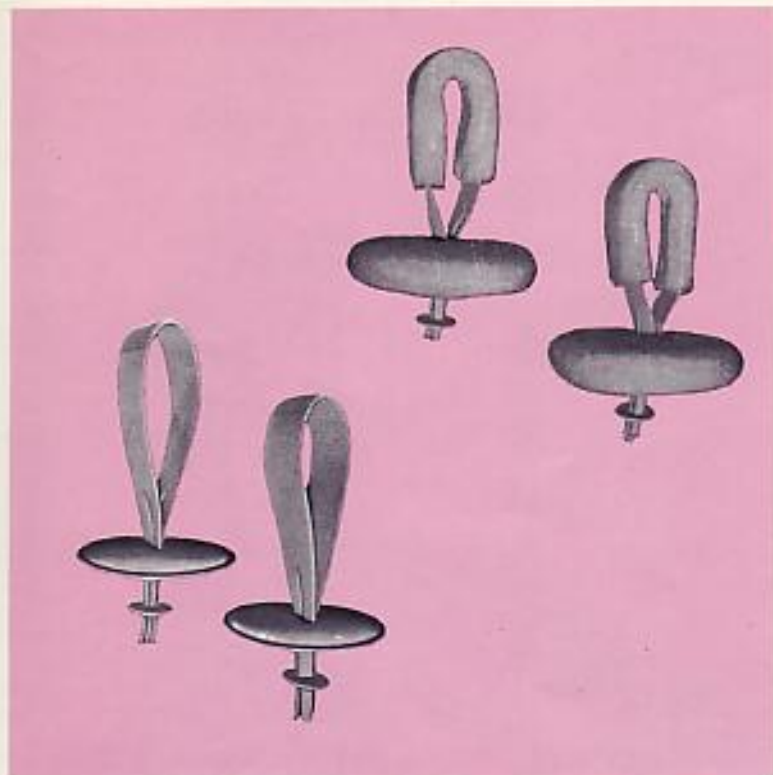

THE CORRECT WAY TO TIE A CYMBAL KNOT



Lay the four leather ends flat in the cymbal cup

Fold No. 1 to the right and over No. 2

Fold No. 2 downward and over No. 1

Fold No. 3 to the left and over No. 2

Fold No. 4 upward over No. 3 and under No. 1
Pull ends tight.



CYMBAL POUCH

Strong plasti-leather with zipper and heavy duty handles. Removable shoulder strap. Puff design for added protection and to accommodate cymbals with straps and pads attached. Name and address card holder is built in.

Be sure to state size.

14", 15", 16", 17", 18"	\$16.50
19", 20", 21", 22"	24.00

WOOD CYMBAL HANDLES

249 Pair\$2.25

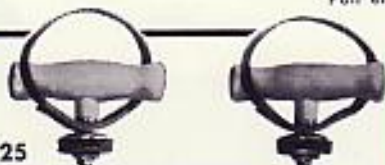

AVEDIS ZILDJIAN GONGS AND STANDS

Cast of Zildjian Metal. Deep, rich, powerful, realistic gong tones.

20"	\$ 60.00B
22"	70.00B
24"	90.00B
26"	100.00B
28"	120.00B

1592 Gong Stand. Folding Legs. Ring Made to Order. State Size\$30.00

1594 Heavy Gong Mallet 10.00B



CAMCO'S NEW ADJUSTABLE THROW OFF CYMBAL SIZZLER



Sizzler On

No. 730
Price \$3.60

Patent No.
3,009,379



Sizzler Off

CAMCO DELUXE PEDAL

**"THE PEDAL OF
PEERLESS PERFORMANCE"**

The vast number of "Big Names" who are using the Camco Deluxe Pedal is definite proof that it has stood the test of time and fully meets the exacting demands of the Modern Drummer.

Its mechanical perfection plus rugged construction are two of the chief reasons for its popularity.

Simplicity of adjustments eliminates guess-work and permits the Drummer to arrive at the desired feel, balance and flow; and with just the right amount of resistance that suits him best . . . This assures smooth, easy and fast action at all tempos.

Positively frictionless and quiet.

Here is the pedal that does not divert the mind, allowing the Drummer to put more emphasis on stick technique.

5000 \$22.50
Ball Bearings

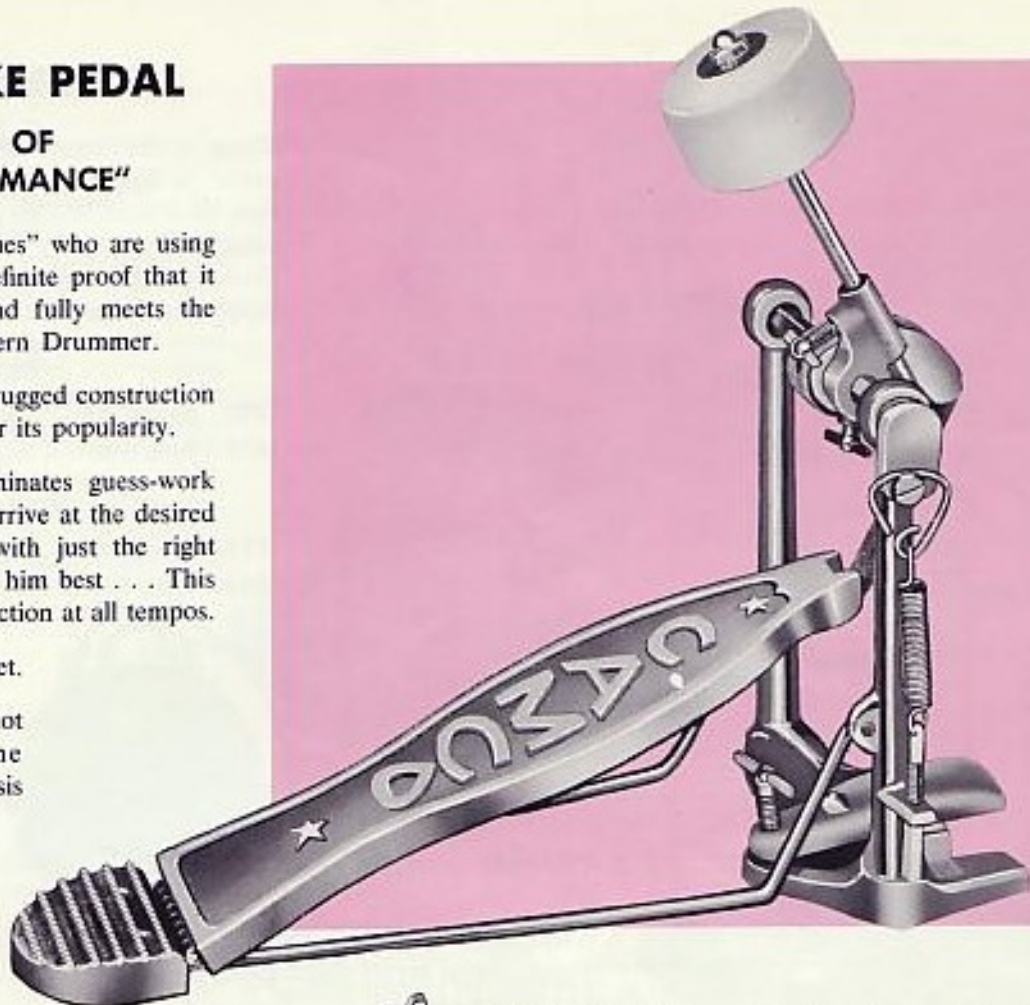

Polished aluminum and chromium-plated parts . . . equipped with solid felt beater ball unless otherwise specified . . . weighs only 3½ lbs. . . . folds easily and compactly without removing any parts whatever.

CAMCO STANDARD PEDAL

"Exceptional Efficiency in a Lower-Priced Model"

Polished aluminum and baked enamel parts . . . equipped with cork beater ball . . . weighs 3½ lbs. . . . folds compactly without removing any parts.

6000 \$16.95
Ball Bearings



CYMBAL HOLDERS

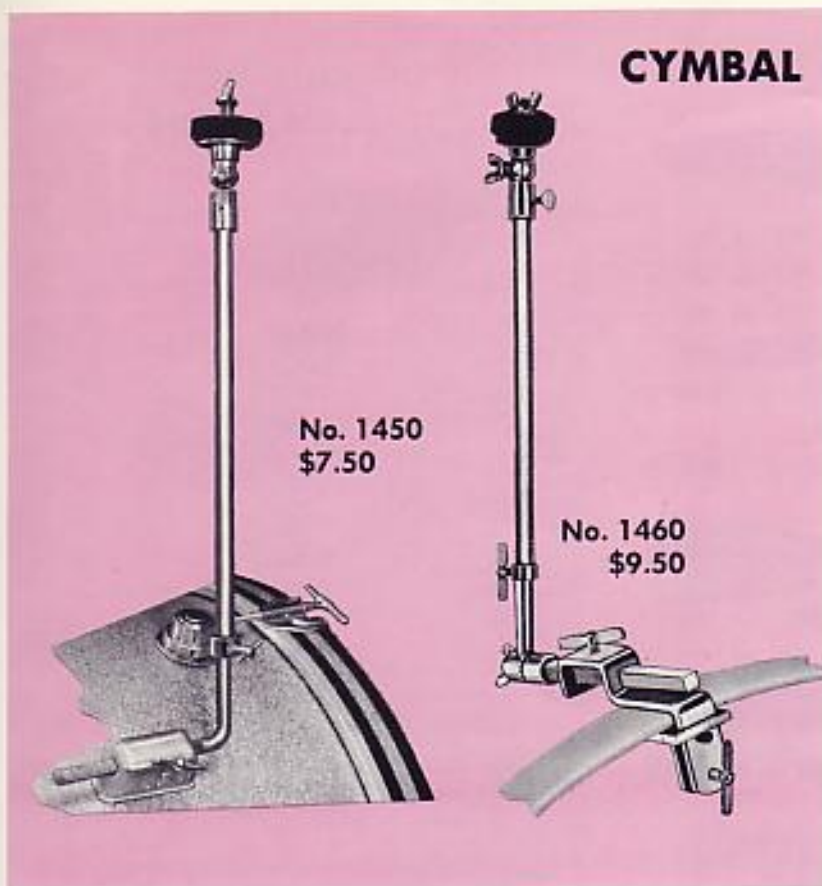

No. 1450
\$7.50

No. 1460
\$9.50



No. 1470
\$9.50

The square rod fits into square holes in both hoop clamp and the shell mount holders—it cannot turn—the ratchet angle-adjusting cymbal rod holds like a solid piece.



NOT THIS



Old style is flat—resting on top of the hoop at the center (see arrow) only. This design permits side-sway.

THIS



Patented 2971738
Feb. 14, '61

All Camco Hoop Clamps curve where they rest on top of the hoop, assuring a firm grip at the edges (see arrows) which prevents side-sway.



Tilters included

Disappearing shell mount cymbal holder. Chrome.
No. 1440 . . . \$5.00

Height adjusting telescope cymbal sleeve. Chrome Only.
No. 1445 \$4.00

...NOW YOU CAN BE SURE!

TOM-TOM HOLDERS

BRUSH CYMBAL HOLDER

A new high post model.
Cymbal is placed higher for less
reaching and it has the extra
strong "Camco" hoop clamp.

1428- Chromium AAA\$2.90



SINGLE COW BELL HOLDER

1422 With 1 clamp.....\$3.00



COW BELL CLAMP

Prevents bell from turning.

1431 Chrome70¢

WOOD BLOCK HOLDER

Block is held at both ends. No
swinging out of place. The "Cam-
co" hoop clamp really holds.

1424- Chromium AAA\$3.80



DOUBLE COW BELL AND WOOD BLOCK HOLDER

A new and more efficient set-
up for cow bells and wood
block. Ideal for Latin numbers
and all other effects. Placed
higher than other models . . .
better for speed and comfort.
No extra reaching.

1420- Chromium AAA\$5.70



BAND CYMBAL HOLDER

Heavy extra strong holder with
two "Camco" hoop clamps that
prevent slipping.

1427- Chromium AAA\$5.80



THE CONSOLETTA TOM-TOM HOLDER



A popular model which has full adjust-
ments. Well made and very strong.

1435-C Chrome\$12.75

1435-N Nickel 9.75

1435-CD Chrome Double
Tom-Tom Holder 18.00

DOUBLE TOM-TOM HOLDER



14\$18.00

Chrome plated

PLASTIC DRUM HEADS

CRISP, EASY PLAYING,
EVEN TENSION DRUMS
ASSURED... RAIN OR SHINE

Thousands now in use among leading professionals and in the schools.

CAMCO TOM-TOM OR BATTER SIDE

For 12" Shell.....	\$7.50
For 13" Shell.....	7.50
For 14" Shell.....	7.50
For 15" Shell.....	7.50
For 16" Shell.....	7.50

CAMCO SNARE SIDE

For 13" Shell.....	\$6.50
For 14" Shell.....	6.50
For 15" Shell.....	6.50
For 16" Shell.....	6.50

TYMPANI

25"	\$21.00
28"	24.00

WEATHER KING BATTER SIDE OR TOM-TOM

For 13" Shell.....	\$7.00
For 14" Shell.....	7.50
For 15" Shell.....	8.00
For 16" Shell.....	8.50

WEATHER KING SNARE SIDE

For 13" Shell.....	\$6.00
For 14" Shell.....	6.50
For 15" Shell.....	7.00
For 16" Shell.....	7.50

CAMCO BASS DRUM

For 18" Shell.....	\$15.00
For 20" Shell.....	\$17.00
For 22" Shell.....	18.00
For 24" Shell.....	19.00
For 26" Shell.....	21.00
For 28" Shell.....	22.00
For 30" Shell.....	23.00
For 32" Shell.....	25.00

Please Order by Size of Drum Shell Only

CALF DRUM HEADS

BATTER SIDE — WHITE CALF

	Unmounted	Mounted
17" for 13" Shell.....	B17 \$7.20	MB17 \$ 8.70
18" for 14" Shell.....	B18 7.70	MB18 9.20
19" for 15" Shell.....	B19 8.50	MB19 10.00
20" for 16" Shell.....	B20 9.10	MB20 10.60

Mounted on metal flesh hoop — Add \$1.70.

SNARE SIDE — TRANSPARENT CALF

	Unmounted	Mounted
17" for 13" Shell.....	S17 \$5.60	MS17 \$ 7.10
18" for 14" Shell.....	S18 6.10	MS18 7.60
19" for 15" Shell.....	S19 6.70	MS19 8.20
20" for 16" Shell.....	S20 7.20	MS20 8.70

Mounted on metal flesh hoop — Add \$1.70.

TOM-TOM — WHITE CALF

	Unmounted	Mounted
16" for 12" Shell.....	T16 \$6.60	MT16 \$ 8.10
17" for 13" Shell.....	T17 7.20	MT17 8.70
18" for 14" Shell.....	T18 7.70	MT18 9.20
20" for 16" Shell.....	T20 9.10	MT20 10.60

BASS DRUM — WHITE CALF

	Unmounted	Mounted
23" for 18" Shell.....	B23 \$13.00	MB23 \$15.50
27" for 22" Shell.....	B27 18.90	MB27 22.90
29" for 24" Shell.....	B29 20.30	MB29 24.30
31" for 26" Shell.....	B31 22.20	MB31 26.20
33" for 28" Shell.....	B33 24.00	MB33 28.00
35" for 30" Shell.....	B35 25.60	MB35 29.60
37" for 32" Shell.....	B37 27.70	MB37 31.70

TYMPANI — TRANSPARENT CALF

	Unmounted	Mounted on Your Hoop
31" for 25" Bowl.....	T31 \$30.50	MT31 \$34.50
32" for 26" Bowl.....	T32 31.50	MT32 35.50
33" for 27" Bowl.....	T33 32.50	MT33 36.50
34" for 28" Bowl.....	T34 33.50	MT34 37.50
Metal Tympani Flesh Hoop—25" or 28", each.....		\$7.50
Other sizes, made to order, each.....		9.00

We will be glad to make special selections of heads when requested and will exchange if not entirely satisfactory, provided the head has not been wet or used.

All prices subject to change without notice.



1530
1531



164



122



1104 1103 1102 1101



117



106
123



124L
124M



119L
119S



100M
100MN



165



100S
100NS

CAMCO WOOD BLOCKS

Made of one-piece rock maple. Rich "clock" (not "click") sound.

1530	6½"	\$2.50
1531	7½"	2.80

COW HORN GUIROS

Genuine Horn. Hand Carved.

124L	Large	\$6.00
124M	Medium	4.50

CLAVES

Genuine grenadilla wood, professional size.

106	Pair	\$3.00
	Regular size.		
123	Pair	\$1.00

MARACAS

These are genuine Mexican handmade—hand finished. They come in various colors with hand carved floral designs. Available also in a natural wood finish with hand-painted native scenes.

100S	Overall colors and hand-carved floral designs.		
	Pair	\$2.50
100NS	Overall natural wood finish and handpainted scenes.	Pair 2.50
100M	Overall colors and hand-carved floral designs.	Pair 4.50
100MN	Overall natural wood finish. Hand-painted scenes.	Pair 4.50

MARACA STICKS

Used on tom-toms for a combined maraca effect.

164	Pair	\$3.00B
-----	------	-------	---------

COW BELLS

These pressed steel bells are polished and finished in a new and durable imitation chrome plating.

7¼"	5¾"	4½"	3¾"
1104	1103	1102	1101
\$2.90	\$2.10	\$1.85	\$1.50

GUIROS

Handmade wood guiros. Highly polished. Lacquer colors.

117	With Scratcher	\$5.25
-----	----------------	-------	--------

WOOD SHAKER

122	Hand Made. Polished	\$5.25
-----	---------------------	-------	--------

TIMBALE STICKS

165	15" Long. Pair	50¢
-----	----------------	-------	-----

METAL-TUBO-SHAKERS

Plenty of volume. Will cut thru large band. Very effective.

119L	Large	\$3.00
119S	Small	1.50

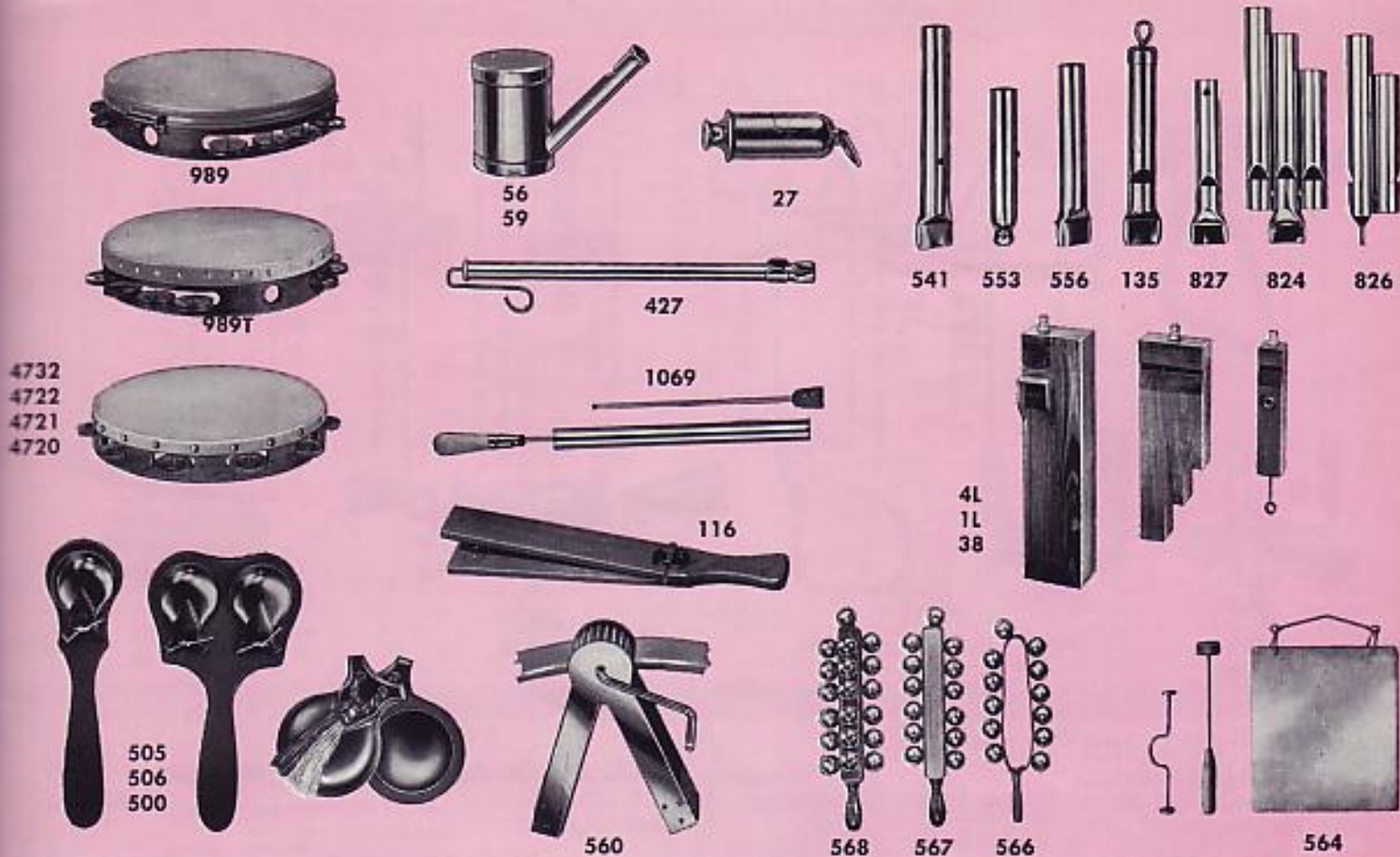

"NO TACK" TAMBOURINE

Solid maple shell. No tacks or staples. Head held by metal band fitting into recessed groove in shell. Easy to replace heads.

989 10" Diameter—12 Pair Jingles.....\$10.75

STANDARD TAMBOURINE

Solid maple shell. Standard construction. High grade model.

989T 10" Diameter—12 Pair Jingles.....\$9.00

REGULAR TAMBOURINES

Maple shells — calf heads. Excellent tambourines. Low priced.

4732 10"—17 Pr. Jingles, Double row.....\$12.00

4722 10"— 9 Pr. Jingles 9.50

4721 8"— 6 Pr. Jingles 7.50

4720 7"— 5 Pr. Jingles 6.50

CASTANETS

505 1 Pair on Handles\$2.75

506 2 Pair on Handles 3.75

500 1 Pair for Fingers..... 1.10

BIRD WHISTLES

56 Warbler—Large\$3.00

59 Canary—Small 2.25

ACME SIREN WHISTLE

27 Made in England.....\$3.75

SLIDE (SONG) WHISTLE

427\$4.50

POP GUN

1069 Sure Fire, Loud\$9.00

METAL IMITATIONS

541 Shanghai Rooster\$1.50

553 Hen Cackle 1.50

556 Baby Cry 1.50

135 Bob White 1.80

827 Cuckoo 3.00

824 3-Tone Train 9.00

826 2-Tone Train 7.50

SLAP STICK

116 Rock Maple\$4.50

WOOD RATTLE

Clamps to bass drum hoop. Rock maple ratchet in a metal frame. Very loud and durable.

560\$6.50

WOOD WHISTLES

4L Ocean Liner\$13.50

1L Locomotive 12.00

38 Cuckoo 9.00

SLEIGH BELLS

568 25 Bells\$10.50

567 13 Bells 6.75

566 12 Bells 4.50

STEEL BELL PLATE

564 7"x9"x1/8"—Mallet included.....\$5.00



1429



810 807
809 806
808 805



429-C



430-C



1541-C



443-C
443-N



1663-C
1663-N



1115



1502-C
1502-N



1503-C
1503-N

TRIANGLE HOLDER

You can be sure that this extra strong holder will remain in place. Gut suspension cord.

1429-Chromium AAA\$2.50

TRIANGLES

Fine grade steel. Brilliant tones. Heavily plated. Striker included.

810	10"	\$3.15	807	7"	\$1.85
809	9"	2.60	806	6"	1.60
808	8"	2.10	805	5"	1.40

ONE COW BELL HOLDER

429-C Chrome\$2.00 429-N Nickel\$1.20

TWO COW BELL HOLDER

430-C Chrome\$3.00 430-N Nickel\$2.40

WOOD BLOCK HOLDER

1541-C Chrome\$1.35 1541-N Nickel\$1.00

WOOD BLOCK AND COW BELL HOLDER

443-C Chrome\$2.70
443-N Nickel 1.95

TIMBALE WOOD BLOCK AND COW BELL HOLDER

1663-C Chrome\$3.25
1663-N Nickel 2.50

INTERNAL SNARE DRUM MUFFLER

Only Vertical Control on Market. Very Fast.

1115\$3.00

"SPREAD-OUT" WOOD BLOCK AND COW BELL HOLDER

1502-C Chrome\$4.75
1502-N Nickel 3.75

"STEP-UP" WOOD BLOCK AND COW BELL HOLDER

1503-C Chrome\$4.75
1503-N Nickel 3.75

JINGLE MUFFLER

Ideal accessory for your Bass Drum for a Rock and Roll Effect.



1421\$8.50



CAMCO BASS DRUM MUFFLER

This new idea bass drum muffer has risen to a top favorite in six months time. No springs to deteriorate or rust. The pressure adjustment is directly in center of felt disc. Any color pearl to match your drums. Your choice of Pearls. Please state pearl desired.

1426 All metal parts chrome plated\$6.00
1430 3"x25" Bass Felt Muffer\$1.00

MUSSER MALLET



M-1 1" Soft Yellow Rubber \$2.20	M-2 1" Medium Red Rubber \$2.20	M-3 1" 1/2 Hard Blue Rubber \$2.20	M-4 1" 3/4 Hard Gray Rubber \$2.20	M-5 1" Hard White Plastic \$2.50	692 3/4" Solid Brass Balls \$1.50	M-6 1 1/8" Hard Red Yarn \$3.75	M-7 1 1/8" 1/2 Hard Blue Yarn \$3.75	M-8 1 1/8" Med. Soft Yellow Yarn \$3.75	M-9 1 1/4" Soft Gray Yarn \$4.00	M-10 1 1/2" Soft Gray Yarn \$4.50	M-12 1 5/8" Soft Gray Yarn \$5.00
---	---	---	---	---	---	---	---	--	--	---	---

- M-1** Ideal for practice and 4 mallet playing
- M-2** Excellent for ensemble and solo
- M-3** For greater volume
- M-4** For Xylophone and Bells—Hard
- M-5** For Xylophone and Bells—Very Hard
- 692** For Bells—Metallic effect
- M-6** For Vibe and Marimba—2, 3, and 4 mallets
- M-7** Special for Vibe—2, 3, and 4 mallets
- M-8** For Marimba—2, 3, and 4 mallets
- M-9** For Vibe and lower register Marimba
- M-10** For lower register Marimba
- M-12** Heavy, for volume, lower register Marimba



BELL-LYRAS AND STAND

Made in 3 sizes

All models 25 bars each. Tapered tubular steel chrome plated frames, plumes, sling, mallet and cover included.

The "EL CAPITAN"

Bars—1 1/4"x3/8". Weight—12 lbs.
Height—28".

300\$135.00

The "DRESS PARADE"

Bars—1 1/4"x1/8". Weight—10 1/2 lbs.
Height—26".

330\$117.00

The "AMERICAN PATROL"

Bars—1"x1/4". Weight—7 lbs.
Height—24".

310\$96.50

BELL-LYRA STAND

Folding and with tilting adjustment.

1477N Nickel\$18.00

1477C Chrome 22.00

LEATHER BELL-LYRA SLINGS

Fine top-grain sole leather.

Single,	4855	White\$12.50
	4853	Tan 9.00
Double,	4857	White 15.00
	4856	Tan 12.00

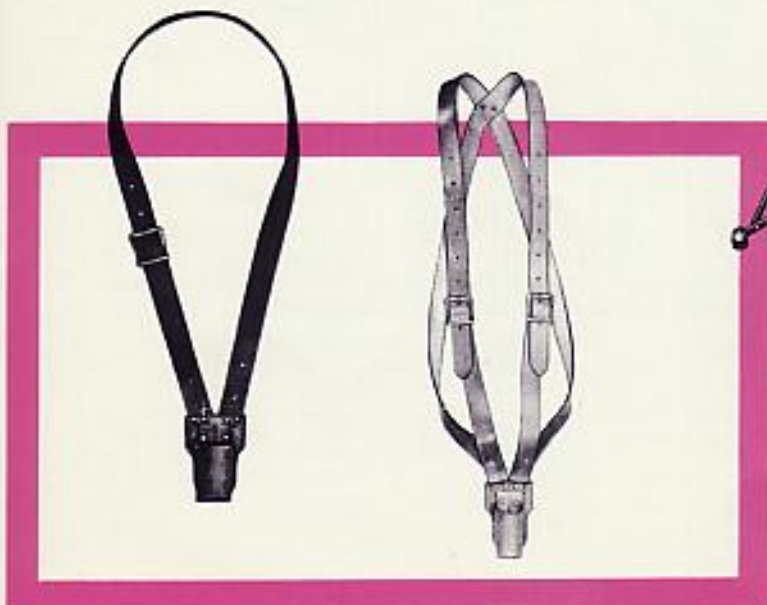

PURDUE BELL-LYRA MALLETS



New balance assures accurate aim—positively guaranteed unbreakable balls. The strongest mallets ever made. You can be sure that the balls will not break. Shafts are of 1/8" special alloy carbon magnesium steel made to our order. The hand grips are semi-hard ribbed rubber. These exclusive features provide a new feel and balance that means better control and therefore better playing technique. One of the most outstanding inventions ever presented in the percussion dept. They are slightly higher in cost because of better materials and workmanship, but they will outlast dozens of the old style models, therefore are much cheaper in the long run.

Originally presented by a member of the Purdue Engineering School and used with great success in the famous Purdue Symphonic Band—Al G. Wright, Conductor—in concert and rugged playing on the football field. Developed and made exclusively by Camco Drum Company by permission of Purdue Bands and available to all musical organizations.

1050 Pair\$3.80

SCOTCH BASS DRUM STICKS



Lamb's Wool
Soft Leather
Thongs
14" Overall

1012
\$6.40

Hi-Grade
Medium Hard Felt
Leather Thongs
14" Overall

1014
\$5.40

Super Grade
Medium Hard Felt
Leather Thongs
14" Overall

1016
\$6.40



All sticks are packaged in full length vinylite bags.

All stick handles except the wood bass drum beater are finished in Hi-Grade glossy white enamel.

CAMCO TENOR DRUM STICKS

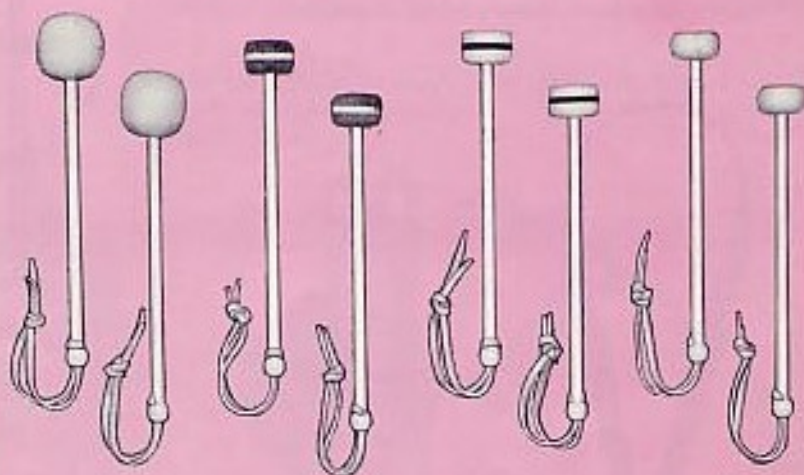

SOFT
Lamb's Wool
12" Overall

1020
\$5.90

SEMI-HARD
Hi-Grade Felt
12" Overall

1022
\$4.90

SEMI-HARD
Super-Grade Felt
12" Overall

1023
\$5.60

SOLID
Medium Felt
11 3/4" Overall

1024
\$5.40

CAMCO BASS DRUM STICKS



Lamb's Wool Double End Extra Length 17½" Overall	Lamb's Wool Double End Regular Length 16" Overall	Lamb's Wool Single End Wood Grip 15" Overall	Lamb's Wool Single End With Sling 15" Overall	Felt Hi-Grade Medium Hard Double End 13½" Overall	Felt Hi-Grade Medium Hard Wood Grip 13" Overall	Felt Super Grade Hard Wood Grip 13" Overall	Felt Hi-Grade Medium Hard With Sling 13" Overall	Felt Hi-Grade Medium Wool Grip With Sling 13" Overall
1001	1002	1003	1004	1005	1006	1007	1008	1009
\$5.40	\$5.20	\$4.70	\$5.70	\$4.30	\$3.50	\$4.20	\$5.50	\$5.90

"ARTIST" Lamb's Wool Fixed Ball	"PROFESSIONAL" Piano Felt	"CONCERT" Piano Felt	"MIDGET" Piano Felt	"HEAVI-TONE" Solid Hard Felt
1030	1032	1036	1038	1040
\$5.40	\$5.00	\$5.00	\$4.50	\$4.40

CAMCO TYMPANI STICKS

We use only top grain "pearl elk" leather for all thongs.

The Metal retaining washers on all except tympani sticks are of special design and AAA Chromium plated.



No. 21



No. 20



No. 40



No. 30



ZIPPER DRUM COVERS

All sizes are shell measurements only — allowance is made for hoops. Please state type and size when ordering.

SNARE DRUM

	Mackintosh	Naugahyde		Mackintosh	Naugahyde
4x13	\$7.80	\$10.50	5½x14	\$7.80	\$10.50
4½x14	7.80	10.50	6½x14	7.80	10.50
5x14	7.80	10.50	8x15	7.80	10.50

PARADE DRUM

	Mackintosh	Naugahyde		Mackintosh	Naugahyde
10x14	\$8.40	\$11.60	12x15	\$9.00	\$12.00
10x15	8.70	11.60	12x16	9.00	12.00

TOM-TOM

	Mackintosh	Naugahyde		Mackintosh	Naugahyde
8x12	\$8.10	\$10.80	14x14	\$9.00	\$12.00
9x13	8.10	10.80	16x16	9.00	12.50

BASS DRUM

	Mackintosh	Naugahyde		Mackintosh	Naugahyde
14x18	\$13.00	\$18.00	10x26	\$15.00	\$20.10
12x20	13.50	18.00	10x28	16.00	21.20
14x20	13.50	18.50	14x28	15.90	21.20
12"x22"	13.50	18.50	14x30	16.80	22.50
14x22	13.50	18.50	16x30	16.80	22.50
12x24	14.25	19.00	16x32	17.70	23.60
14x24	14.25	19.00	16x34	18.60	25.00
8x26	15.00	20.10			

TYMPANI COVERS

Long Skirt—Pair for 25" and 28" Tympani.....	\$18.00
Short Skirt—Pair for 25" and 28" Tympani.....	16.50

FIBRE CASES

SUPER CARRY-ALL FIBRE CASE

No. 21 Extra Large. Will Hold 22" Cymbal Has tray and partition.....	\$38.70 B
---	-----------

REGULATION CARRY-ALL CASE

No. 20 Has tray and partition Will Hold 15" Cymbal and Extras.....	38.30 B
---	---------

STUDENT CASE

Deluxe Case — Blue.....	15.80
-------------------------	-------

TRAY FRAME CASE

Metal edge frame . . . will hold 16" Cymbal.

No. 40	\$30.60 B
--------------	-----------

PLAIN FIBRE CASE

Plain edge frame . . . will hold 16" Cymbal.

No. 30	\$20.50 B
--------------	-----------

TELESCOPE SNARE DRUM

14" Dia. Shell.....	\$13.40 B	15" Dia. Shell.....	\$14.10 B
---------------------	-----------	---------------------	-----------

Will take drums up to 8" shell depth.

SQUARE SNARE DRUM

472 14" Dia. Shell... ..	11.80 B	473 15" Dia. Shell... ..	13.10 B
--------------------------	---------	--------------------------	---------

For drums up to 6½" shell depth.

PARADE DRUM

10x14	\$16.30 B	12x16	\$18.90 B
12x15	18.10 B		

TOM-TOM

8x12	\$14.50 B	14x14	\$18.25 B
9x13	15.00 B	16x16	19.50 B

BASS DRUM

14x20	\$33.10 B	10x28	\$35.80 B
14x22	33.30 B	14x28	35.80 B
14x24	34.10 B	14x30	38.60 B
14x26	35.00 B	14x32	40.00 B

TELESCOPE FIBRE CASES

SQUARE SNARE

REPLACEMENT PARTS LIST

STRAINERS

830	Aristocrat Strainer\$9.50
845	Economy Strainer 4.50
841	Snare Jaw 1.00

TENSION CASINGS

846	Aristocrat Snare Casings\$1.20
847	Aristocrat Bass Casings 1.40
848	Tuxedo Snare Casings 1.20
849	Tuxedo Bass Casings 1.40
851	Collar Screw Hoop for Single Flange Hoop40
852	Claw Hook for Bass Drums80
853	Claw Hook for Parade Drum80
856	Casing for Cymbal Holder or Tom Tom Legs 1.50
854	Tympani Handle Rods (State Size)90

HI-HAT PARTS

800-202	Leather Strap\$.45
800-1	Spring30
800-2	Round Felt Washer16
800-3	Round Steel Washer20
800-4	Round Washer and Bushing30
800-5	Base Casting 2.00
800-6	Large Wing Screw for Base60
800-7	Strap Screw20
800-8	Hex Leg for Heel10
800-9	Crutch Tip for Leg on Heel10
800-10	Rubber Bumper and Screw for Heel10
800-11	Footboard Connection 1.00
800-12	Metal Hinge45
800-14	1/4-20 Wing Screw Wide Spread34
800-15	1/4-20 Wing Screw25

CRUTCH TIPS AND MISCELLANEOUS PARTS

1200-1	1" I.D. Tip for Bass Drum Rack\$.30
800-13	Crutch Tip for 800-600-700 Stands10
9000-2	3/8" I.D. for Throne and Spurs10
9000-1	Locking Ring and Screw for Throne80
600-6	Large Knurl Nut for 600 Drum Stand40

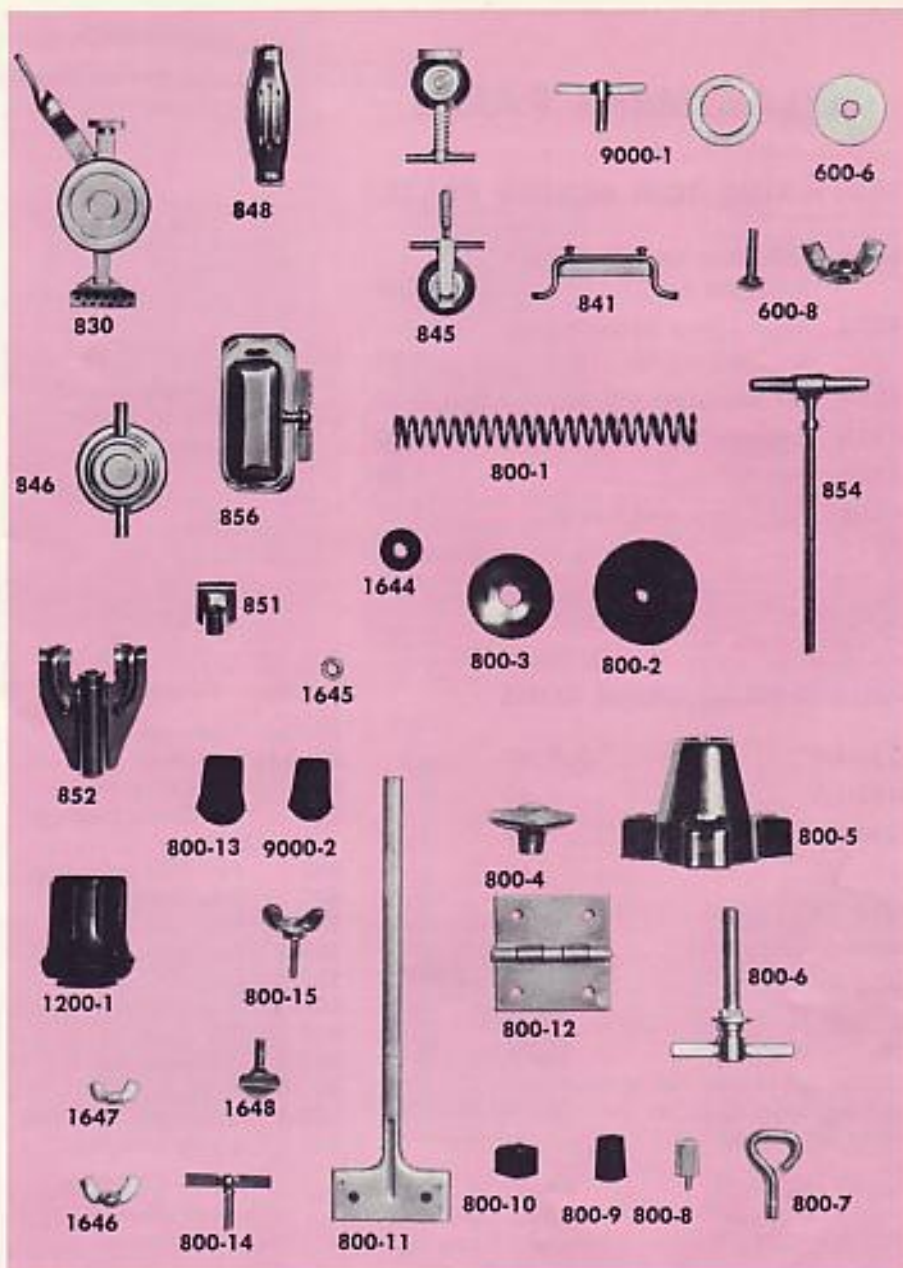

600-8	Bolt and Large Wing Nut25
1646	1/4-20 Wing Nut10
1647	10-24 Wing Nut08
1648	1/4-20 Thumb Screw12
1643	Rubber Cymbal Tube06
1644	Leather Washer06
1645	Tension Rod Washer06
1649	10-24 Thumb Screw10

COUNTER HOOPS

Chrome Triple Flange, Snare Side\$9.50
Chrome Triple Flange, Batter Side 9.00
Wood Bass, Maple 6.00
Wood Bass, Lacquer 6.50
Wood Bass, Pearl Inlaid 7.50
Parade Hoop, Maple 3.00
Parade Hoop, Lacquer 3.50
Parade Hoop, Pearl Inlaid 4.50

REPLACEMENT PARTS

1435 - TOM TOM HOLDER PARTS

- 1435-1 Rail Complete with washers, bolts and nuts.....\$6.00
- 1435-2 Small Clamp complete nut, bolt, and washer 1.00
- 1435-3 Diamond plate with nuts and bolts 3.50
- 1435-4 Extension Rod, Long or Short.... 1.00
- 1435-5 Hex Key 1.00
- 1435-6 Rail Clamp and Ratchet..... 5.00

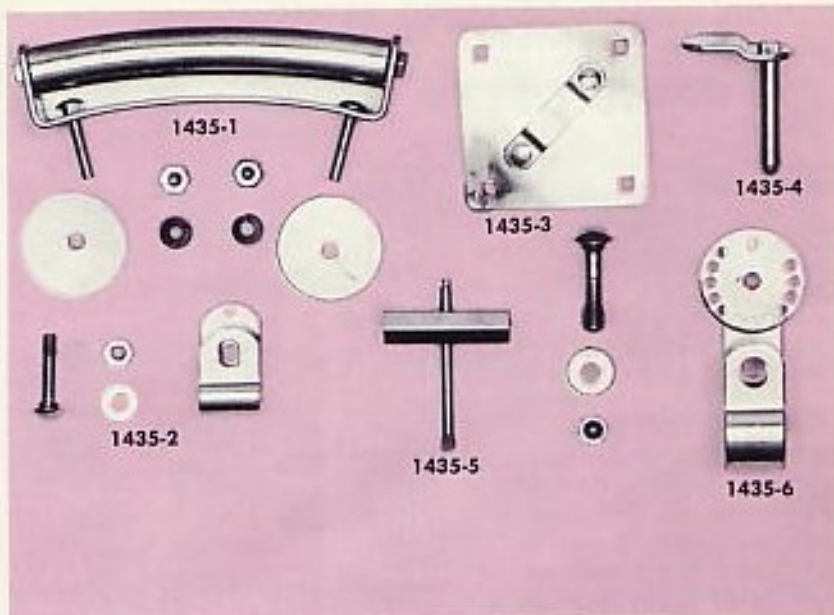

SQUARE HEAD DRUM RODS

- 4150-1½" \$.40
- 4187-1¾"40
- 4250-2½"40
- 4300-3"40
- 4350-3½"50
- 4400-4"50
- 4450-4½"50
- 4500-5"50



Chrome plated. All rod measurements are taken from under the collar to the end of the threads.

Part No.	Description	List Price	Part No.	Description	List Price
5000-F	Footboard only	\$4.00	403	Spring	\$.22
5000-H	Heel only	1.25	402	Spring Screw	.15
604	Toe Clamp Pin	.06	401	Rocker	.30
603	Toe Clamp Locking Screw	.40	400-A	Rocker and Spring Assembly	.82
602	Toe Clamp Casting	.85	307	Cam Side Bearing Nut	.05
601	Base Casting	6.00	305	Rocker Hub	.20
507-2	Heel Screws	.06	302-2	Bearing	.50
506-2	Footboard Screws	.06	300-A	Hex Shaft Assembly	2.75
505	Rivets (4/4) 2	.03	203-2	Cam Strap Screws	.05
504	Heel Clip	.15	202	Cam Strap	.45
503	Flat Block	.15	201	Cam Casting	1.25
502-L	Leather Hinge	.30	103	Hex Shaft Set Screw	.35
502-M	Metal Hinge	.45	102	Beater Shaft Set Screw	.35
500-A	Radius Rod Assembly	1.75	101	Beater Hub Casting	1.25
404	Spring Lock Nut	.15	5000-C	Complete Footboard	7.50

Camco Pedal Parts

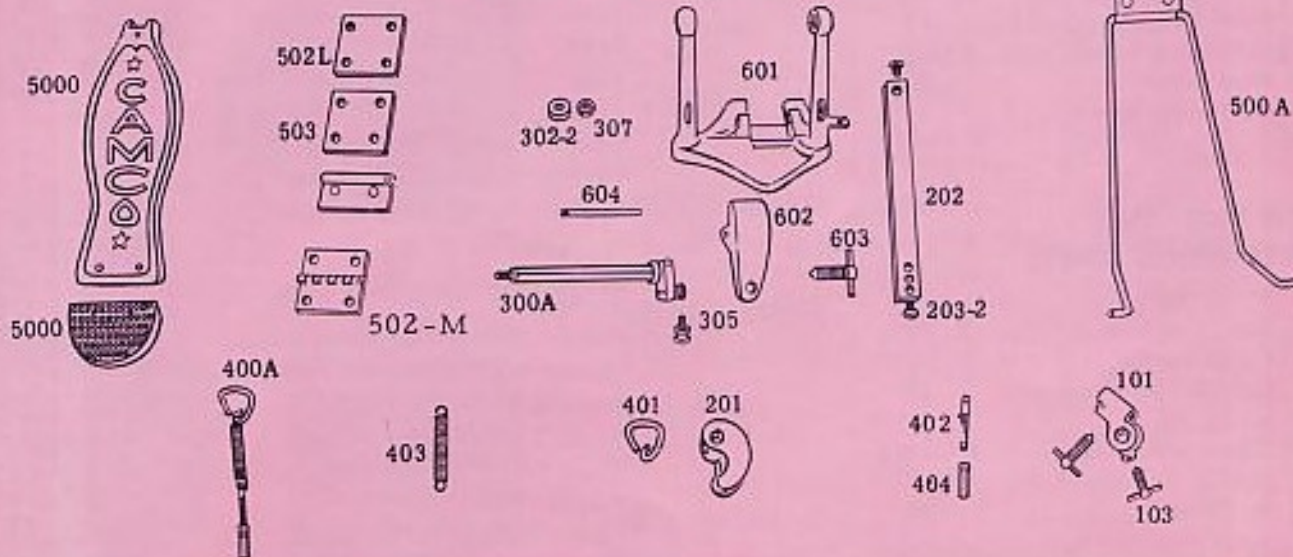

INSTRUCTION BOOKS

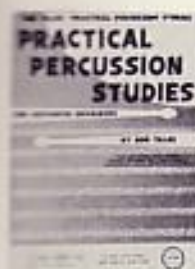

**PRACTICAL
PERCUSSION STUDIES**
BOB TILLES — \$4.00B

Designed for the playing drummer. Contains typical modern scores for both jazz and classical music. Exercises include the use of the entire drum set. Modern syncopated studies for use with and without the entire drum set.



**LATIN-AMERICAN
HUMBERTO MORALES
AND HENRY ADLER**
\$3.00B

... contains a series of exercises written for Latin-American instruments, together with numerous illustrations showing the correct method of playing these instruments. The text is written in both Spanish and English.



**A MODERN APPROACH
TO INDEPENDENCE FOR
THE ADVANCED
DRUMMER**

NICK CEROLI—\$4.00B
This book is designed to give drummer ability to play one rhythm against another.

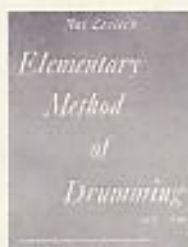

**ELEMENTARY METHOD
OF DRUMMING**

NAT LESLIE—\$1.50B
This new method book is for beginners who wish to learn how to play the most important rhythm instrument in any jazz band, concert orchestra or rock and roll combo.



TYMPANI METHOD
**ALFRED FRIESE AND
ALEXANDER LEPAK**
\$5.00B

A complete method for TYMPANI in 4 parts: BASIC THEORY, TECHNIQUE, INTONATION and REPERTOIRE ... written and assembled to fill an urgent need by America's leading authorities.



DRUM METHOD No. 1
HASKELL W. HARR
\$1.50B

A tremendous book for both teacher and student, explains fully all fundamentals, notation and rudiments.



DRUM METHOD No. 2
HASKELL W. HARR
\$1.50B

Reviews carefully previous studies with stronger emphasis on rudiments and advances the student to competition solo work.



**AROUND THE DRUMS
WITH TRIPLETS**
PAUL CAPOZZOLI—
Vol. 1 \$1.50

A book to help drummer technique and ideas for his own solos.



**AROUND THE DRUMS
WITH OPEN ROLLS**
PAUL CAPOZZOLI—
Vol. 2 \$1.50

A book written to help the student develop technique and solo ideas of his own.



**SYNCOATED ROLLS
FOR THE MODERN
DRUMMER**
JIM BLACKLEY

A book designed to help in the development of rhythmic sense and the abundance of roll possibilities available.
Vol. 1—\$2.50
Vol. 2— 2.50

"SNAPPI" COILED WIRE SNARES



1240	12 Strand for 13" Drums.....	\$3.00
1241	12 Strand for 14" Drums.....	3.00
1242	12 Strand for 15" Drums.....	3.00
1245	16 Strand for 14" Drums.....	3.30
1247	16 Strand for 15" Drums.....	3.30
1250	20 Strand for 14" Drums.....	3.50
1251	20 Strand for 15" Drums.....	3.50
1252	20 Strand for Super	4.50



TERRY CLARKE
John Handy



MARTY CLAUSEN
Art Van Damme



JOE DUKES
Jack McDuff



EDDIE GRAHAM
Juan Exquival



NORM JEFFRIES
Hollywood Palace



DREW JOHNSON
Righteous Brothers



JERRY GRANELLI
Denny Zeitlin



CORT AVERRE
Dick Averre Trio



HAP GORMLEY
New York



NICK CEROLI
Tijuana Brass



EDDIE KNIGHT
South Bend, Indiana



ALEXANDER LEPAK
Hartford, Conn.



KALIL MADI
The Three Sounds



BOB GARVIN
Santa Ana, California



RICHARD MEISLER
New York



PAUL HUMPHREY
Harry James



ALLEN LASCHOVER
Santa Ana, California



JOEL PALMER
Brazil 66



MARSHALL THOMPSON
Eddie Higgins



NICK MARTINIS
Pete Jolly



DENNIS WILSON
Beach Boy's

PURDUE BELL-LYRA MALLETS



New balance assures accurate aim—positively guaranteed unbreakable balls. The strongest mallets ever made. You can be sure that the balls will not break. Shafts are of 1/8" special alloy carbon magnesium steel made to our order. The hand grips are semi-hard ribbed rubber. These exclusive features provide a new feel and balance that means better control and therefore better playing technique. One of the most outstanding inventions ever presented in the percussion dept. They are slightly higher in cost because of better materials and workmanship, but they will outlast dozens of the old style models, therefore are much cheaper in the long run.

Originally presented by a member of the Purdue Engineering School and used with great success in the famous Purdue Symphonic Band—Al G. Wright, Conductor—in concert and rugged playing on the football field. Developed and made exclusively by Camco Drum Company by permission of Purdue Bands and available to all musical organizations.

1050 Pair\$3.80

SCOTCH BASS DRUM STICKS



Lamb's Wool
Soft Leather
Thongs
14" Overall

1012
\$6.40

Hi-Grade
Medium Hard Felt
Leather Thongs
14" Overall

1014
\$5.40

Super Grade
Medium Hard Felt
Leather Thongs
14" Overall

1016
\$6.40



All sticks are packaged in full length vinylite bags.

All stick handles except the wood bass drum beater are finished in Hi-Grade glossy white enamel.

CAMCO TENOR DRUM STICKS

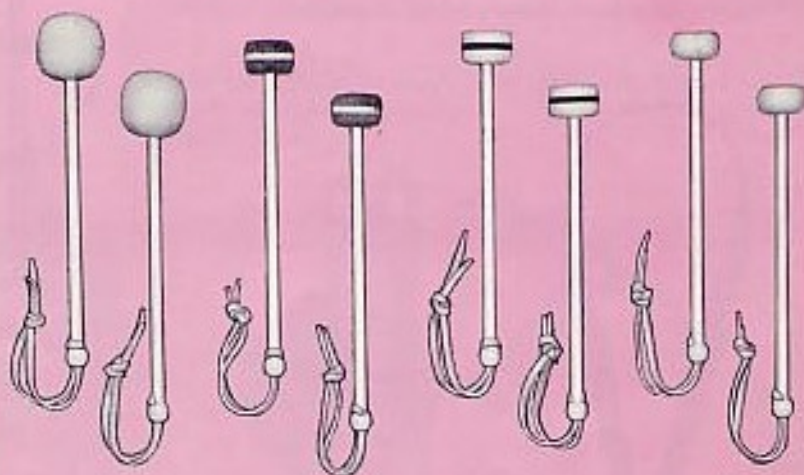

SOFT
Lamb's Wool
12" Overall

1020
\$5.90

SEMI-HARD
Hi-Grade Felt
12" Overall

1022
\$4.90

SEMI-HARD
Super-Grade Felt
12" Overall

1023
\$5.60

SOLID
Medium Felt
11 3/4" Overall

1024
\$5.40