



pearl drums

REMO
MADE IN
MADE IN
USA

Pearl

Pearl...putting



The world's finest players have chosen a drum company that reacts to their needs. Only Pearl offers a "Player-Designed" image that has attracted the elite of the drum world. Heavy-duty hardware that holds up to today's music demands perfectly matched to a choir of drums offering a wider diversity of sound potential through a variety of shell materials. With Pearl, you have a choice... fiberglass shells that seem alive, 9-ply wood shells lined with fiberglass for power and projection, chrome-plated snare drums with brass shells for full, dynamic response. No wonder more recording studios insist on the Pearl Sound... and with the introduction of the Jazz-Rock wood shell series, Pearl offers a price range that anyone can afford. There's a Pearl outfit that will compliment your particular needs, so join the players who rely on Pearl for all their equipment.

it all together!



- 1 Jerry McKenzie
- 2 Joe Corsello
- 3 Mark Stevens
- 4 Keith Knudson
- 5 Gene Pello
- 6 Jesse Sailles
- 7 Frank Guerrero
- 8 Candy Finch
- 9 John Tirabasso
- 10 John Guerin

- 11 Washington Rucker
- 12 Mel Lee
- 13 Don Bailey
- 14 Lew Malin
- 15 Jerry Williams
- 16 Ed Shaughnessy
- 17 Peter Donald
- 18 Buddy Harmon
- 19 Doug Sides
- 20 Shelly Manne
- 21 Colin Bailey

- 22 Chuck Flores
- 23 Louie Bellson
- 24 Butch Miles
- 25 Ralph Humphreys
- 26 Frank Logan
- 27 Les DeMerle
- 28 Steve Schaeffer
- 29 Peter Limonick
- 30 Cozy Cole
- 31 Gene Estes
- 32 Don Williams
- 33 Eddie Locke
- 34 Ken Collier
- 35 Ed Quinn
- 36 Art Blakey
- 37 Eddie Aparicio
- 38 Jack Sperling
- 39 Larrie Londin
- 40 Paul Humphrey
- 41 Alan Estes
- 42 Jimmy Gadson
- 43 Norm Jeffries

- 44 Allen Goodman
- 45 Milch Peters
- 46 Bill Haynes
- 47 Russ Kunkel
- 48 John Hartman
- 49 George Griffin
- 50 Al Cecchi

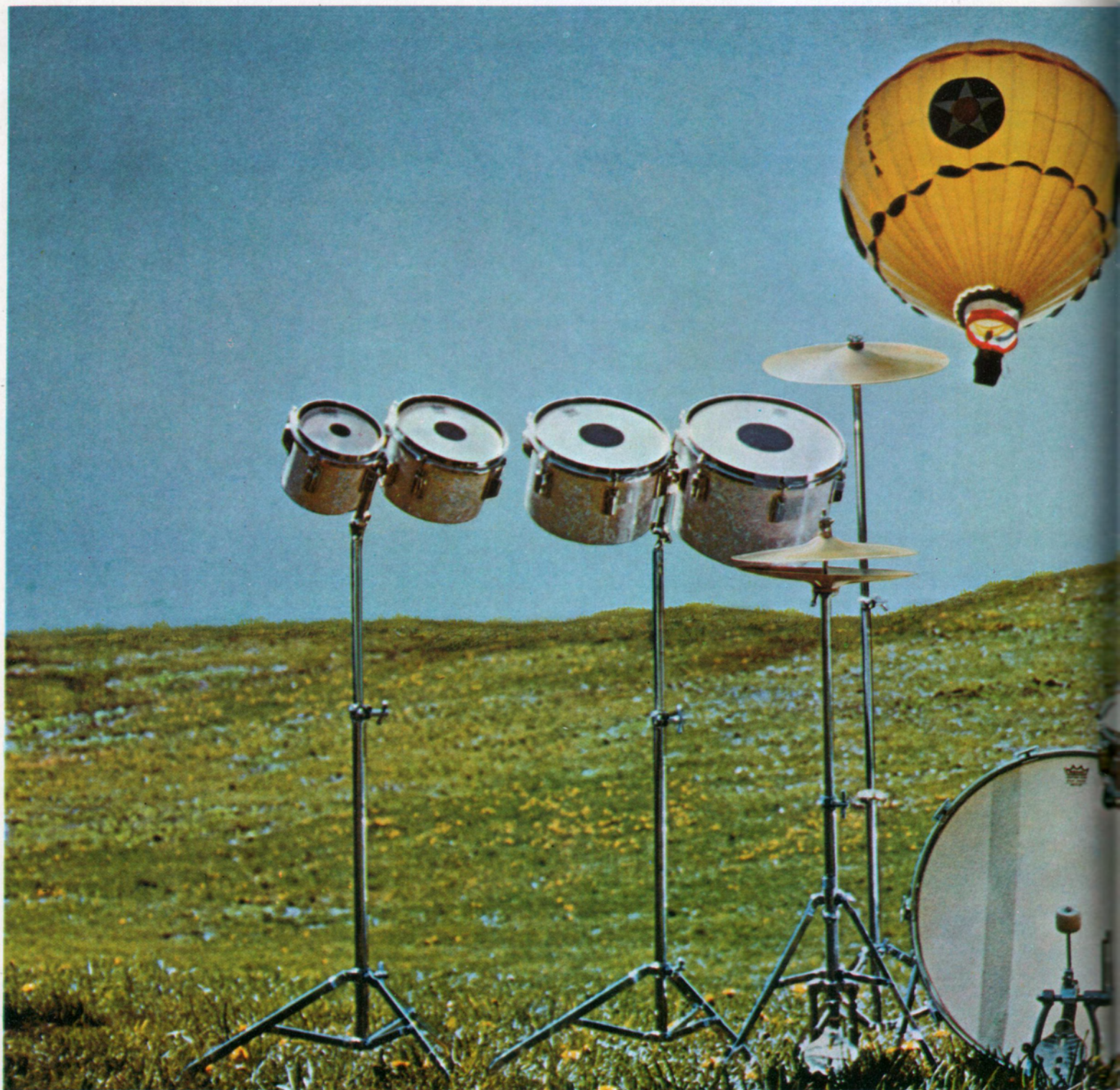

Louie Bellson

Duke Ellington once said, "Louie Bellson has all the requirements for perfection in his craft. He is the world's greatest drummer." Naturally, Louie plays the world's greatest drums... Pearl. Louie is renowned for his innovations—and his Pearl sound is no exception.

Louie's double 10 is an extremely versatile setup. His traditional choir for driving a big band is augmented by the four high-pitched concert toms to cover every facet of today's jazz-rock sounds.

double 10



Outfit includes: Two 224 (14" x 24") Bass Drums ■ Two pairs 786 Spurs, mounted ■ 716S Single Tom-Tom Holder, mounted ■ 213 (9" x 13") Tom-Tom with bracket mounted ■ B4514 (5" x 14", 10 lug) Snare Drum, brass shell, chrome-plated ■ FG6802 Concert Tom set (6", 8", 10", 12") complete with stands (2) ■ Two 216 (16" x 16") Floor Tom-Toms with legs mounted ■ 800 Hi-Hat Stand ■ Two 803 Cymbal Stands ■ 806 Snare Drum Stand ■ Two 810 Bass Drum Pedals

Note: 1. Outfit is available in fiberglass shells (Model F10D) or Pearl's exclusive 9-ply wood shells lined with fiberglass (Model FW10D). Concert Tom shells are only available in fiberglass shells. Specify shell material when ordering.

2. Substitute sizes are available. See price list for color selection and price adjustments on size selections.

3. Cymbals not included.



Ed Shaughnessy

You can hear the sound of Pearl almost every night as Ed Shaughnessy provides the beat of "Doc" Severinsen's band on the Tonight Show. And if you're lucky enough to catch Ed in person, you'll hear him and his Pearl drums leading his big band, ENERGY FORCE. Pearl's Double 9 setup helps Ed feel at home with any style of music.

A bonus feature with the Double 9 is the flexibility of the multiple-sized, mounted tom-toms, which adapt to making up a variety of smaller sets as needed. But, don't listen to us. Tune in the Tonight Show and watch Ed Shaughnessy play everything we're saying.

double 9



Outfit includes: Two 222 (14" x 22") Bass Drums ■ Two pairs 786 Spurs, mounted ■ Two 716T Double Tom-Tom Holders mounted ■ One 212 (8" x 12") Tom-Tom with bracket mounted ■ Two 213 (9" x 13") Tom-Toms with brackets mounted ■ One 216 (16" x 16") Floor Tom-Tom with legs mounted ■ One 2118 (16" x 18") Floor Tom-Tom with legs mounted ■ B4514 (5" x 14", 10 lug) Snare Drum, brass shell, chrome-plated ■ 800 Hi-Hat Stand ■ Two 803 Cymbal Stands ■ 806 Snare Drum Stand ■ Two 810 Bass Drum Pedals

Note: 1. Outfit is available in fiberglass shells (Model F9D) or Pearl's exclusive 9-ply wood shells lined with fiberglass (Model FW9D). Specify shell material when ordering.

2. Substitute sizes are available. See price list for color selection and price adjustments on size selections.

3. Cymbals not included.



Larrie Londin

Nashville country is Pearl country with "Music City's" number one session man, Larrie Londin.

Pearl lets Larrie lead those soothing country and rock sounds you hear with today's top performers.

This is a practical drum outfit, built for playing a wide range of styles. You can add on concert tom choirs at a moment's notice. Or, with Pearl's unique tom-tom holder you can convert to multiple-mounted toms or mounted concert toms with a simple exchange of base plates.

double 6



Outfit includes: Two 222 (14" x 22") Bass Drums ■ Two pairs 786 Spurs, mounted ■ Two 716S Single Tom-Tom Holders, mounted ■ Two 213 (9" x 13") Tom-Toms with brackets, mounted ■ 216 (16" x 16") Floor Tom-Tom with legs mounted ■ B4514 (5" x 14", 10 lug) Snare Drum, brass shell, chrome-plated ■ 800 Hi-Hat Stand ■ Two 803 Cymbal Stands ■ 806 Snare Drum Stand ■ Two 810 Bass Drum Pedals

Note: 1. Outfit is available in fiberglass shells (Model F6D) or Pearl's exclusive 9-ply wood shells lined with fiberglass (Model FW6D). Specify shell material when ordering.

2. Substitute sizes are available. See price list for color selection and price adjustments on size selections.

3. Cymbals not included.



Drummers should be seen and heard. That's why so many artists who want more stage presence want Pearl's Transparent drums. They're made of a unique "Sonaglass" material which is crystal clear in its natural state with properties conducive to the purest color tints.

But, looks aren't everything, and Pearl's Transparents do sound as great as they look. A revolutionary new manufacturing process produces them with no seams. This not only gives them a cleaner, clearer sound, but

also a more durable, perfectly round construction. The shell is one solid piece all the way around.

So, look your best while you sound your best—with Pearl's Transparent drums.

transparents

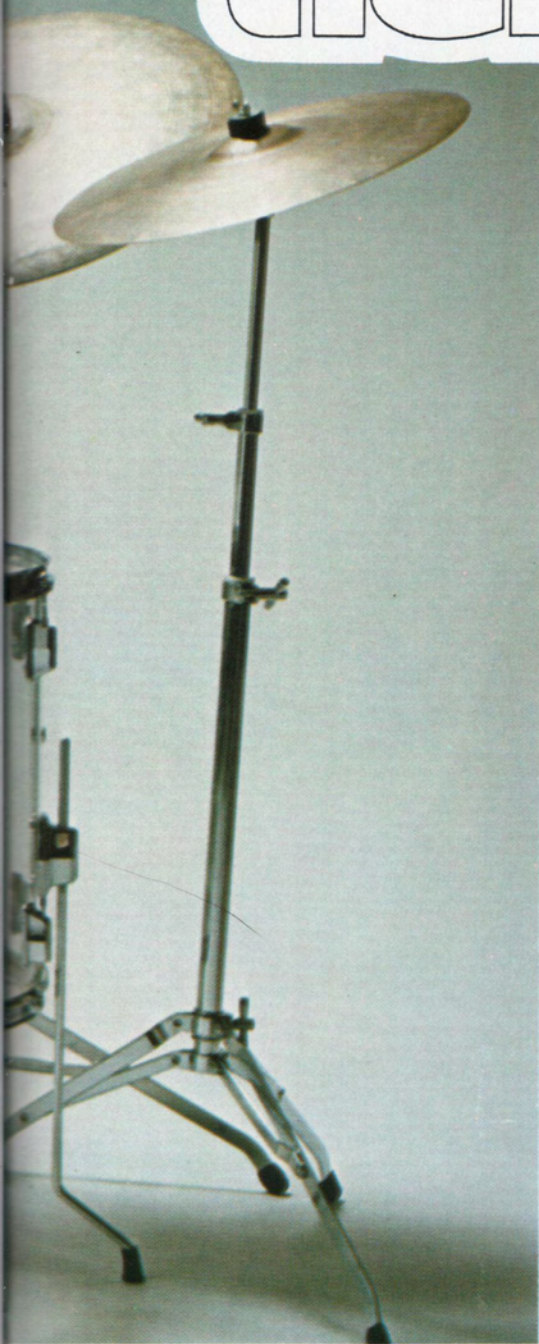

Outfit contains: 222 (14" x 22") Bass Drum ■ Pair 786 Spurs, mounted ■ 716T Double Tom-Tom Holder, mounted ■ 213 (9" x 13") Tom-Tom with bracket ■ 214 (10" x 14") Tom-Tom with bracket ■ 216 (16" x 16") Floor Tom-Tom with legs mounted ■ TP4514 (5" x 14", 10 lug) Snare Drum, seamless shell ■ 800 Hi-Hat Stand ■ Two 803 Cymbal Stands ■ 806 Snare Drum Stand ■ 810 Bass Drum Pedal

Note: The above is the Model TP522 clear outfit. The Model TP5 is also available, which has a 20" bass drum. Both are also available in yellow, red or blue tint. Cymbals not included.



Pearl's Concert Tom shells are made of fiberglass to give you power, durability and an outstanding contemporary sound. You'll find more and more studios featuring Pearl's sound. Unlike wood, these shells are impervious to temperature changes, so the drums retain their pitch longer.

To the drummer with melodic thoughts, they are an indispensable addition to existing equipment because their sounds compliment any musical idea you come

up with. You can take off in any musical direction you want to travel just by adding Pearl's Concert Toms. The eight different sizes add on to any drum set instantly to give you a full range of new sounds. Choose from a pair, to a set of four, high or low, to the ultimate in melodic potential of eight. Your creative styling is never restricted.

tuneables



Model FG6802 includes: FG06 (5½" x 6") Concert Tom with bracket mounted ■ FG08 (5½" x 8") Concert Tom with bracket mounted ■ FG10 (6½" x 10") Concert Tom with bracket mounted ■ FG12 (8" x 12") Concert Tom with bracket mounted ■ Two FG111 High, Double Concert Tom Stands

Model FG3456 includes: FG13 (9" x 13") Concert Tom with bracket mounted ■ FG14 (10" x 14") Concert Tom with bracket mounted ■ FG15 (12" x 15") Concert Tom with bracket mounted ■ FG16 (14" x 16") Concert Tom with bracket mounted ■ Two FG111 Low, Double Concert Tom Stands with spacer blocks

Note: Transparent heads with black sound center patch are standard. All fiberglass shells. See price list for available colors.

big beat



Les DeMette

The big beat for the pro beat. All oversized drums give you power to spare. Here is the perfect setup for the hard-rock drummer who wants to be heard.

Outfit includes: 224 (14" x 24") Bass Drum ■ Pair 786 Spurs, mounted ■ 716T Double Tom-Tom Holder, mounted ■ 213 (9" x 13") Tom-Tom with bracket mounted ■ 214 (10" x 14") Tom-Tom with bracket mounted ■ 216 (16" x 16") Floor Tom-Tom with legs mounted ■ 2118 (16" x 18") Floor Tom-Tom with legs mounted ■ B4514L (6½" x 14", 10 lug) Snare drum, brass shell, chrome-plated ■ 800 Hi-Hat Stand ■ Two 803 Cymbal Stands ■ 806 Snare Drum Stand ■ 810 Bass Drum Pedal

rock beat

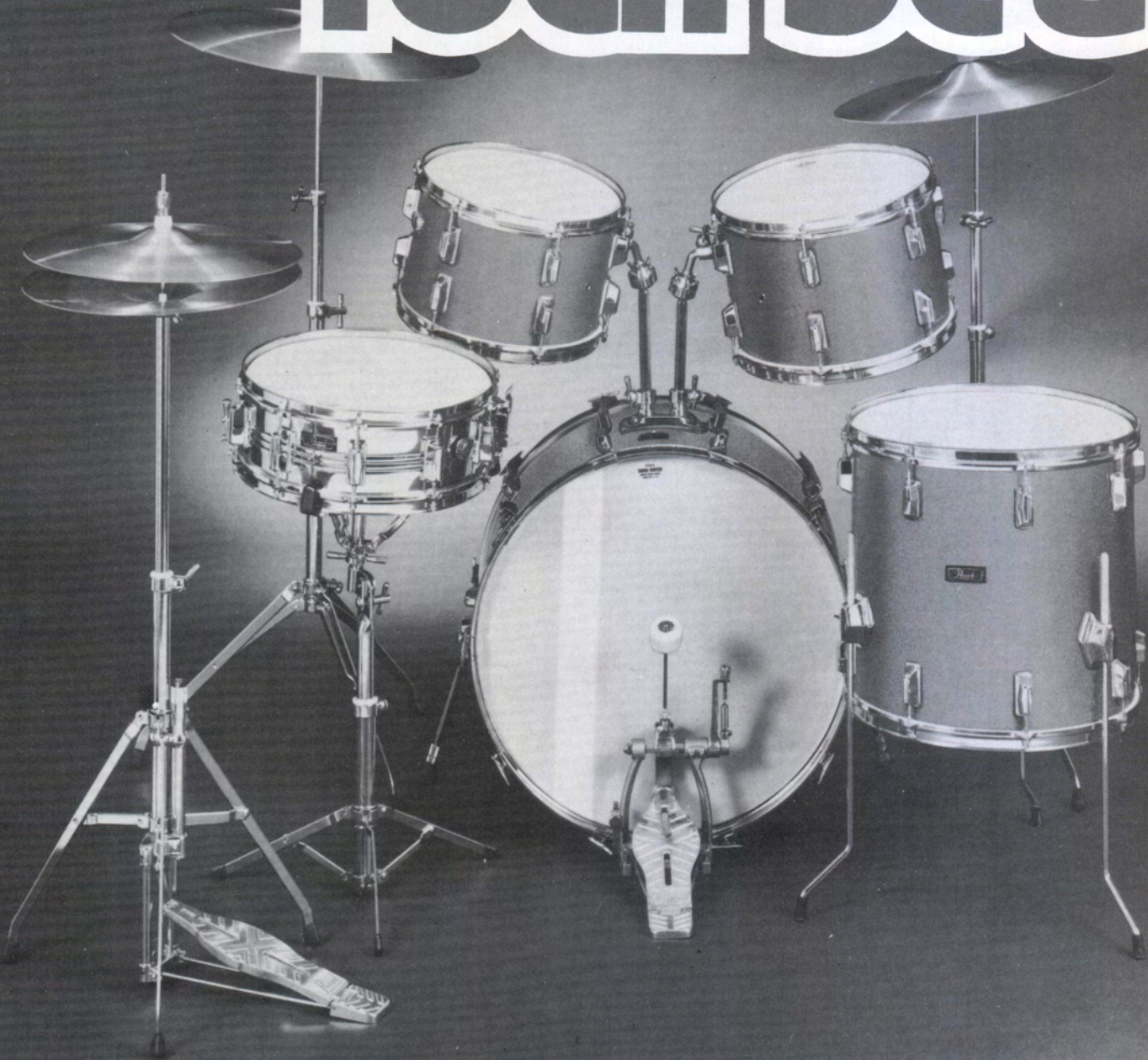

Note: 1. Model F624 (adjacent page) and Model F5 (above) are available in fiberglass shells. Pearl's exclusive 9-ply wood shells lined with fiberglass are available on Model FW624 (adjacent page) and Model FW5 (above). Specify shell material when ordering.

2. Substitute sizes are available. See price list for color selection and price adjustments on size selections.

3. Cymbals not included.

Outfit includes: 222 (14" x 22") Bass Drum ■ Pair 786 Spurs, mounted ■ 716T Double Tom-Tom Holder, mounted ■ One 212 (8" x 12") Tom-Tom with bracket mounted ■ One 213 (9" x 13") Tom-Tom with bracket mounted ■ One 216 (16" x 16") Floor Tom-Tom with legs mounted ■ B4514 (5" x 14", 10 lug) Snare Drum, brass shell, chrome-plated ■ 800 Hi-Hat Stand ■ Two 803 Cymbal Stands ■ 806 Snare Drum Stand ■ 810 Bass Drum Pedal

combo



Shelly Manne

Pearl's Combo outfit is used by jazz great Shelly Manne. This ideal setup lets you fit in comfortably with small combos, yet can deliver enough power to drive a big band. And with Pearl's exclusive tom-tom holder, the set can be converted to a larger outfit. Specify shell material when ordering.

Outfit includes: 220 (14" x 20") Bass Drum ■ Pair 786 Spurs, mounted ■ 716S Single Tom-Tom Holder, mounted ■ 213 (9" x 13") Tom-Tom with bracket mounted ■ 216 (16" x 16") Floor Tom-Tom with legs mounted ■ B4514 (5" x 14", 10 lug) Snare Drum, brass shell, chrome-plated ■ 800 Hi-Hat Stand ■ Two 803 Cymbal Stands ■ 806 Snare Drum Stand ■ 810 Bass Drum Pedal

jazz



Note: 1. Combo Model F420 and Jazz Model F418 are available in fiberglass shells. Pearl's exclusive 9-ply wood shells lined with fiberglass are available on Combo Model FW420 and Jazz Model FW418. 2. Substitute sizes are available. See price list for color/size selection and prices. 3. Cymbals not included.

Outfit includes: 218 (14" x 18") Bass Drum ■ Pair 786 Spurs, mounted ■ 716S Single Tom-Tom Holder, mounted ■ 212 (8" x 12") Tom-Tom with bracket mounted ■ 2114 (14" x 14") Floor Tom-Tom with legs mounted ■ B4514 (5" x 14", 10 lug) Snare Drum, brass shell, chrome-plated ■ 800 Hi-Hat Stand ■ Two 803 Cymbal Stands ■ 806 Snare Drum Stand ■ 810 Bass Drum Pedal



Art Blakey

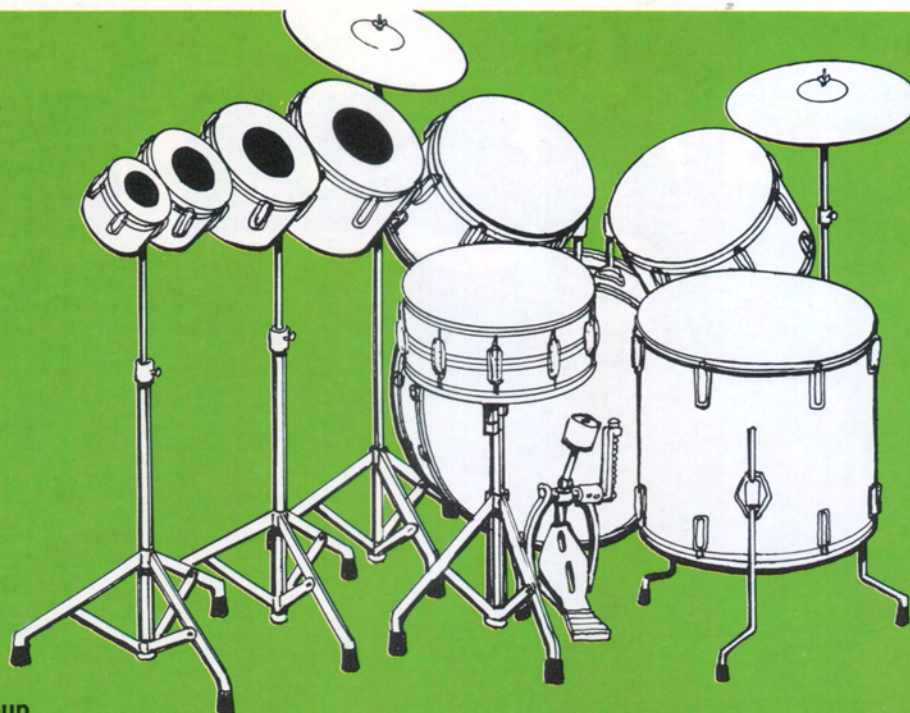

One-Two Punch Set-up

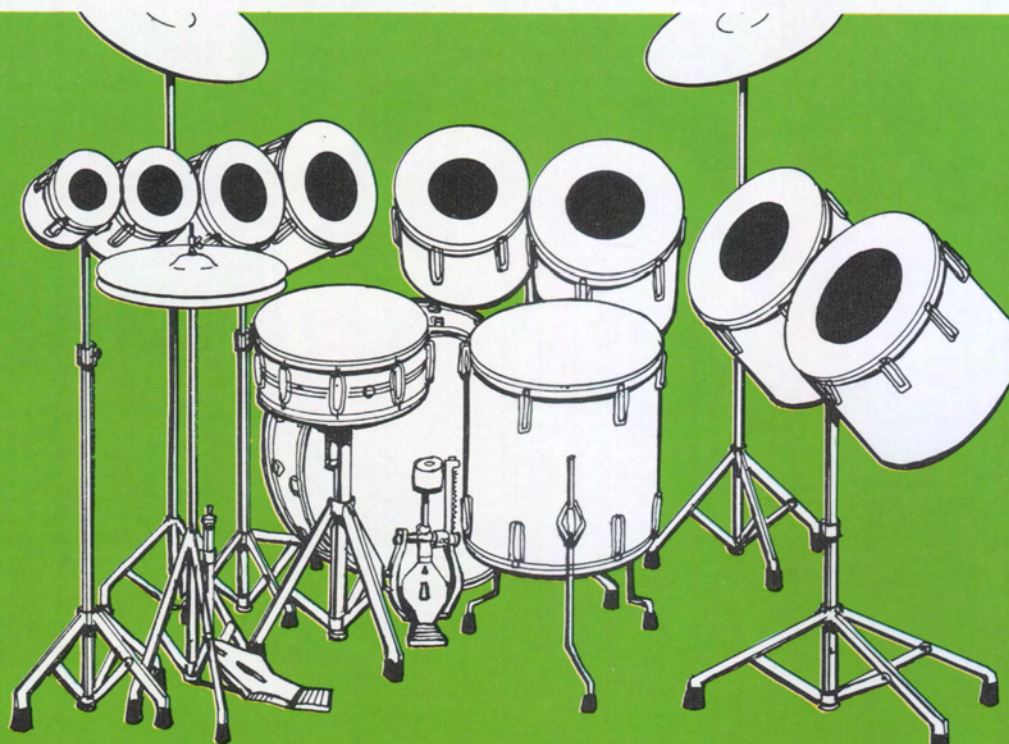

Different Strokes Set-up

One-Two Punch Set-up Model F9—Fiberglass Shells/
Model FW9—Fiberglass Lined Shells.

Outfit includes: 222 (14" x 22") Bass Drum ■ Pair 786 Spurs, mounted ■ 716T Double Tom-Tom Holder, mounted ■ 212 (8" x 12") Tom-Tom w/bracket mounted ■ 213 (9" x 13") Tom-Tom w/bracket mounted ■ 216 (16" x 16") Floor Tom-Tom w/legs mounted ■ FG6802 Concert Toms (6", 8", 10", 12") with stands (2) ■ B4514 (5" x 14", 10 lug) Snare Drum, brass shell, chrome-plated

Different Strokes Set-up Model F11—Fiberglass Shells/
Model FW11—Fiberglass Lined Shells.

Outfit includes: 222 (14" x 22") Bass Drum ■ Pair 786 Spurs, mounted ■ 216 (16" x 16") Floor Tom-Tom w/legs mounted ■ FG6802 Concert Toms (6", 8", 10", 12") with stands (2) ■ FG3456 Concert Toms (13", 14", 15", 16") with stands (2) ■ B4514 (5" x 14", 10 lug) Snare Drum, brass shell, chrome-plated

Set-ups

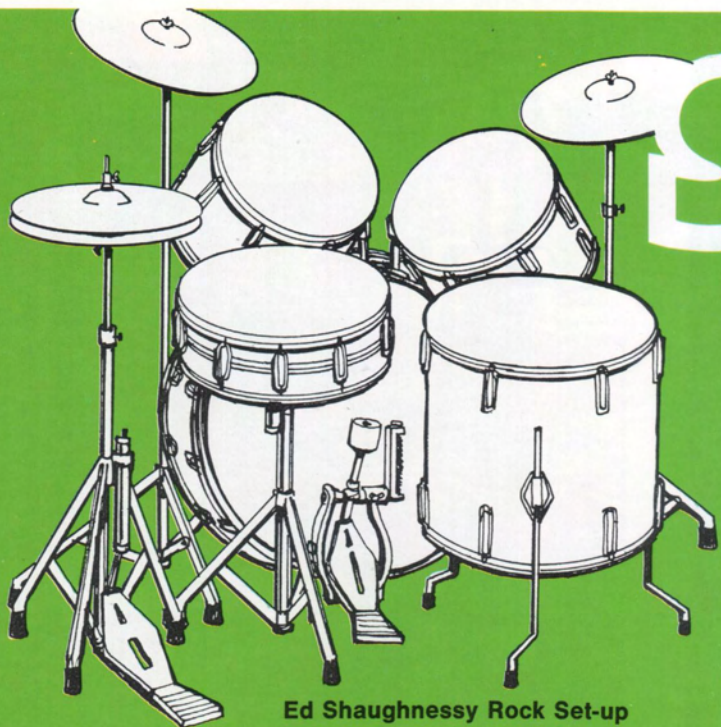

Ed Shaughnessy Rock Set-up

- Note:** 1. All Set-ups shown are available in fiberglass shells or Pearl's exclusive 9-ply wood shells lined with fiberglass. Concert Tom shells are only available in fiberglass shells. Specify shell material when ordering.
2. Substitute sizes are available. See price list for color selection and price adjustments on size selections.
3. Cymbals not included.
4. All Set-ups include 800 Hi-Hat Stand; Two 803 Cymbal Stands; 806 Snare Drum Stand; 810 Bass Drum Pedal.

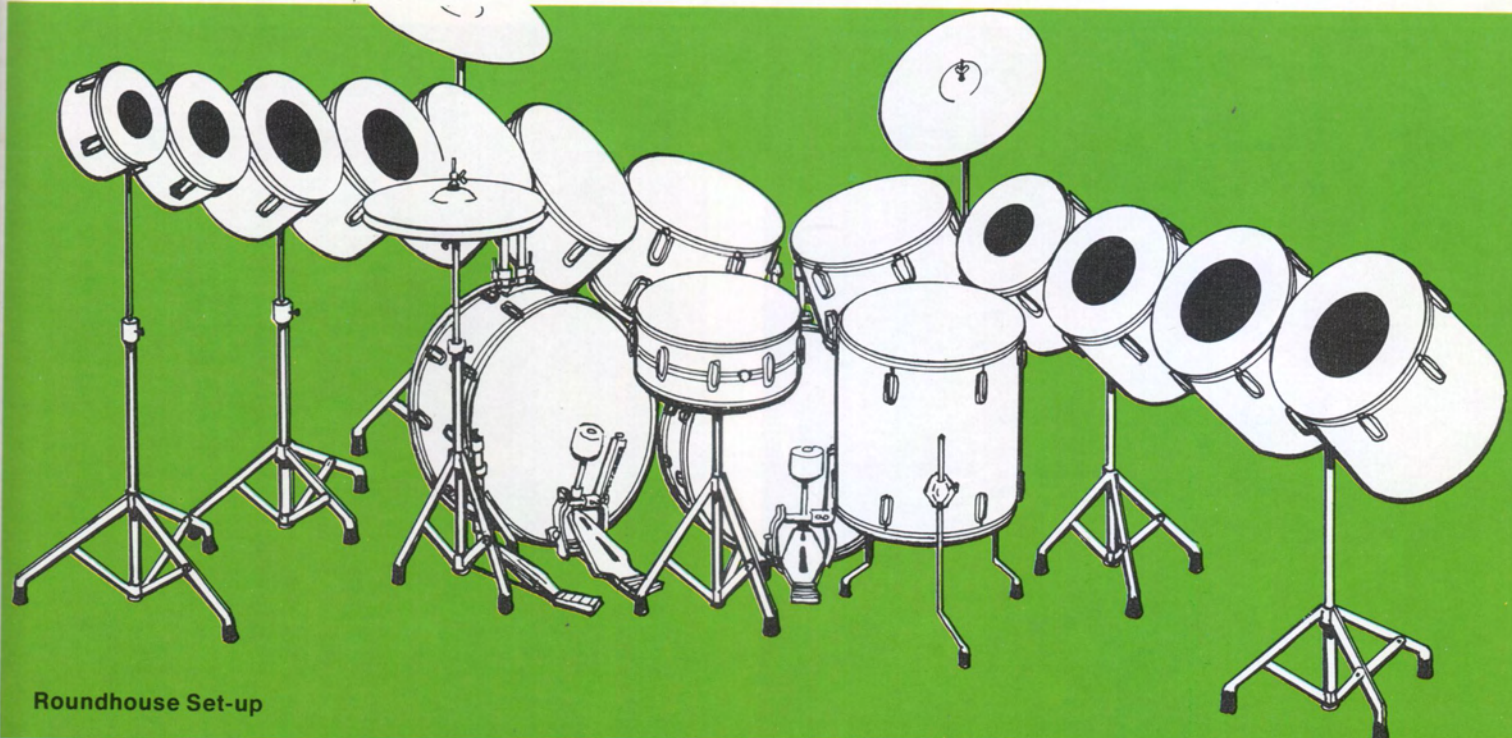

Roundhouse Set-up

Ed Shaughnessy Rock Set-up Model F5S—Fiberglass Shells/Model FW5S—Fiberglass Lined Shells.

Outfit includes: 224 (14" x 24") Bass Drum ■ Pair 786 Spurs, mounted ■ 716T Double Tom-Tom Holder, mounted ■ 213 (9" x 13") Tom-Tom w/bracket mounted ■ 214 (10" x 14") Tom-Tom w/bracket mounted ■ 2118 (16" x 18") Floor Tom-Tom w/legs mounted ■ B4514L (6½" x 14", 10 lug) Snare Drum, brass shell, chrome-plated

Roundhouse Set-up Model F16—Fiberglass Shells/Model FW16—Fiberglass Lined Shells.

Outfit includes: Two 222 (14" x 22") Bass Drums ■ Pair 786 Spurs, mounted ■ 716T Double Holders, mounted ■ 212 (8" x 12"), two 213 (9" x 13"), 214 (10" x 14") Tom-Toms w/brackets mounted ■ 216 (16" x 16") Floor Tom w/legs ■ FG6802 (6", 8", 10", 12"), FG 3456 (13", 14", 15", 16") Concert Toms with stands ■ B4514 (5" x 14", 10 lug) Snare Drum, brass shell, chrome-plated ■ Additional 810 Bass Drum Pedal



a



a



b

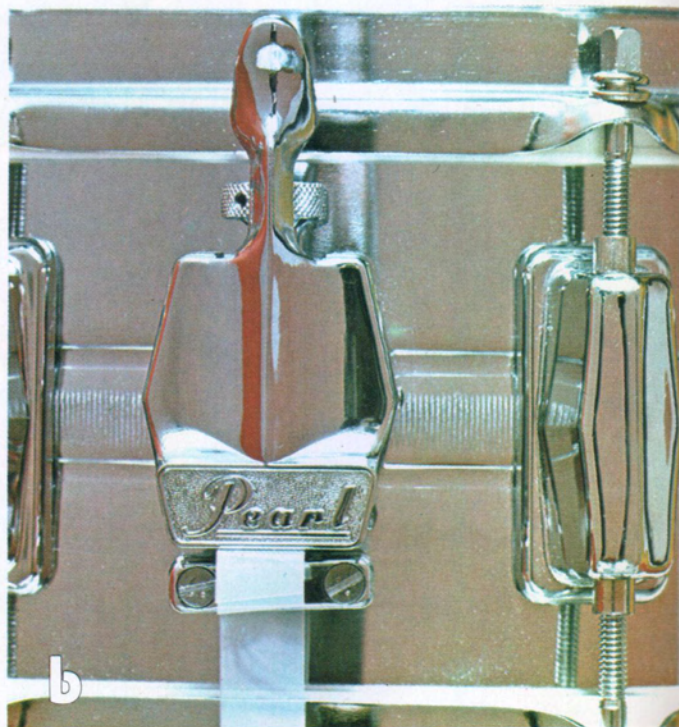

b

a

Jupiter Snare Drum: Available in two sizes—5" x 14" (Model 4814), 6½" x 14" (Model 4814L); parallel action strainer releases both sides of snares simultaneously; extended snares cover entire head for increased sensitivity and response; ten lug brass shell heavily chrome-plated, internal tone control.

Snare Drum: (Not illustrated) 5" x 14" (Model 4614); standard throw off lever; eight lug steel shell; chrome-plated; internal tone control.

b

Snare Drum: 5" x 14"; available with steel shell (Model D4514) or brass shell (Model B4514); chrome-plated; deluxe throw off lever on strainer; ten lugs; internal tone control. Also available in 6½" x 14" size (Model B4514L) and Transparent (Model TP4514).

Components



c



e



d



f

c

Single Tom: Available in three sizes—8" x 12", 9" x 13", 10" x 14"; internal tone control; new design self-adjusting lugs; complete with mounting brackets; two styles—fiberglass-lined wood or all-fiberglass shells.

d

Floor Tom: Available in three sizes—14" x 14", 16" x 16", 16" x 18"; internal tone control; new design self-adjusting lugs; complete with bent shaped legs; two styles—fiberglass-lined wood or all-fiberglass shells.

e

Concert Tom: Available in eight sizes—5½" x 6", 5½" x 8", 6½" x 10", 8" x 12", 9" x 13", 10" x 14", 12" x 15", and 14" x 16"; all-fiberglass shells; single head; Weather King "CS" heads standard with all toms.

f

Bass Drum: Available in four sizes—14" x 18", 14" x 20", 14" x 22", 14" x 24"; two styles—fiberglass-lined wood or all-fiberglass; new design self-adjusting lugs; modern styled tympan handle rods; spurs mounted.

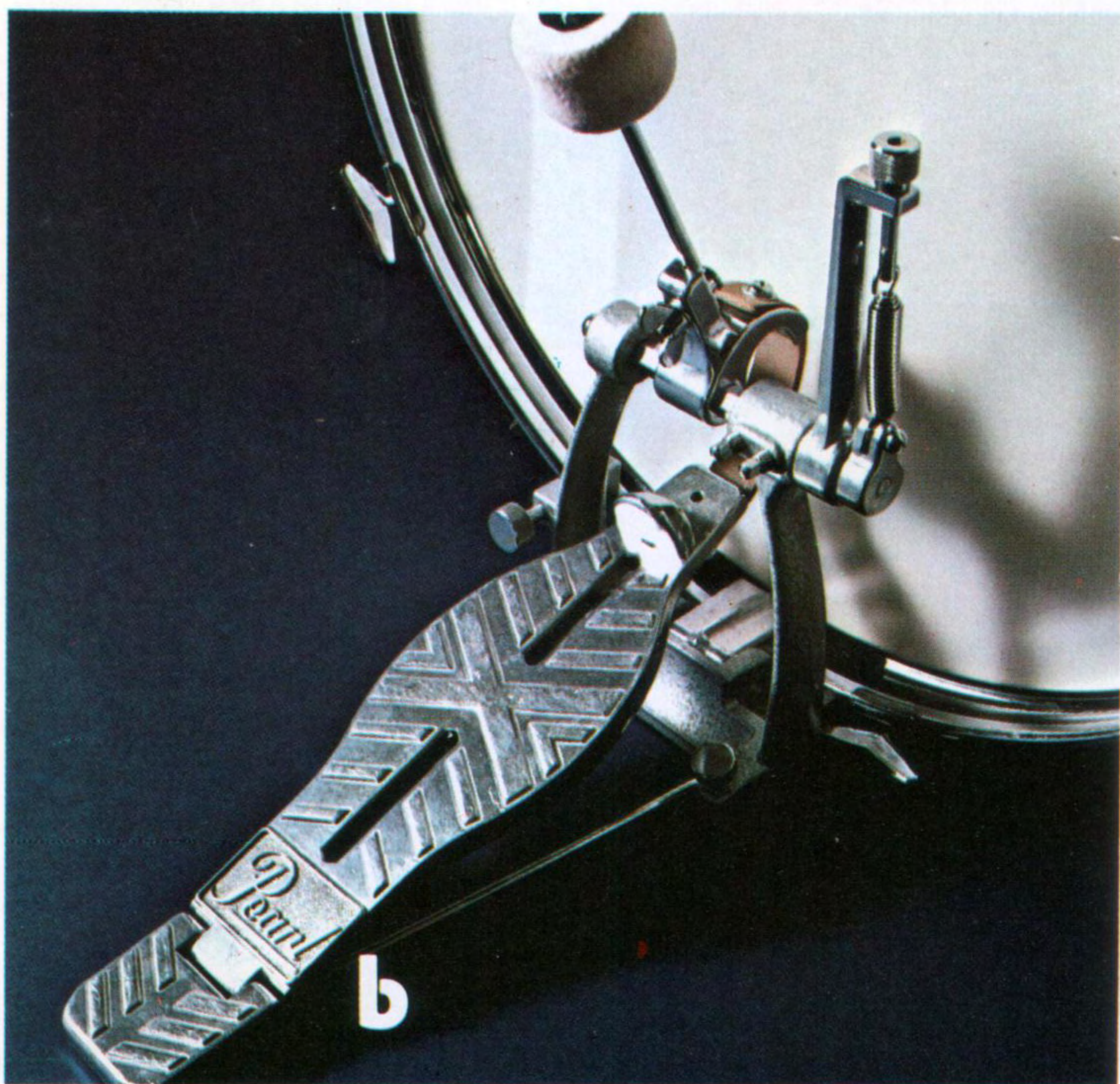

a

Cymbal Stand: Fully adjustable to usable 65" height; nylon lock bushing for no-slip, no-mar tension; new design cymbal tilter adjusts full 90° without slipping.

Double Tom-Tom Floor Stand: Nylon bushing for no-slip, no-mar tension; fully adjustable in all directions; "set-and-forget" design; hexagonal rods prevent twisting or fading.

b

Bass Drum Pedal: Adjustable single-spring action; adjustable stroke length; built-in spurs prevent slippage; unique side-mounted clamp adjustment locks the pedal securely to the drum.

c

Bass Drum Spurs: Unique spur design prevents bass drum creep; over twice the diameter of standard spurs; quick positive locking, fully adjustable; fold flush against drum for easy storage.

d

Hi-Hat Stand: Unique design and Built-in adjustable spur prevent creep; external spring tension adjustable while playing; nylon lock bushing inside telescopic section for no-slip, no-mar tension.

Concert Tom Floor Stand and Bass Drum Shell Mount: Lock through tube with nylon bushing prevents twist and slip; heavy-duty tongues fit tight into adjustable concert tom brackets; Ratchet design tilter.

accessories



e

Snare Drum Stand: Fully adjustable—set at any angle; collapsible; nylon lock bushing inside telescopic section for no-slip, no-mar tension.

f

Throne: Heavily padded (4") seat; rugged construction; fully adjustable and seamless for custom comfort. Also available with round seat.

g

Single Tom Holder: Fully adjustable in all directions; fast, convenient "set-and-forget" design; hexagonal rods prevent twisting or fading.

h

Double Tom Holder: Each tom supported on individual holder; fully adjustable in all directions; "set-and-forget" design; hexagonal rods prevent twisting or fading.

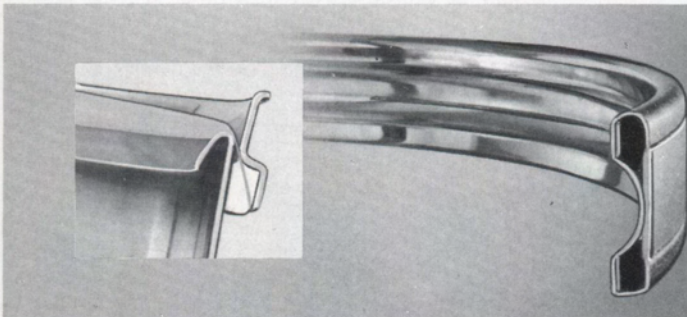
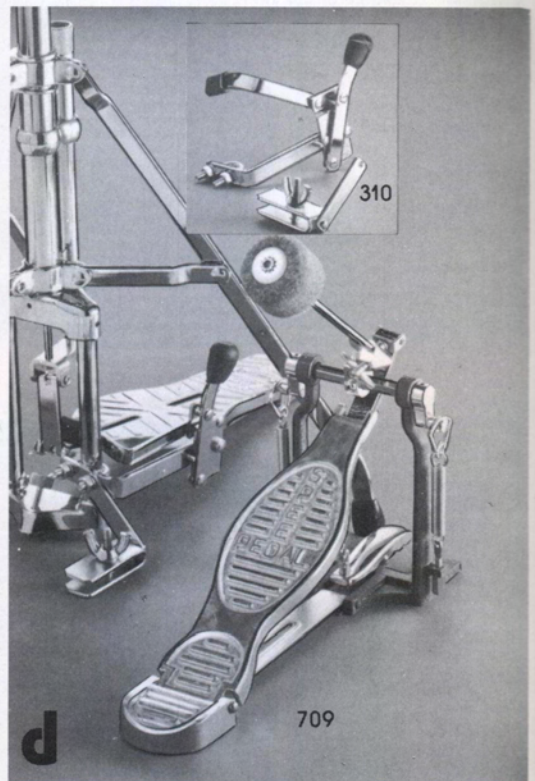
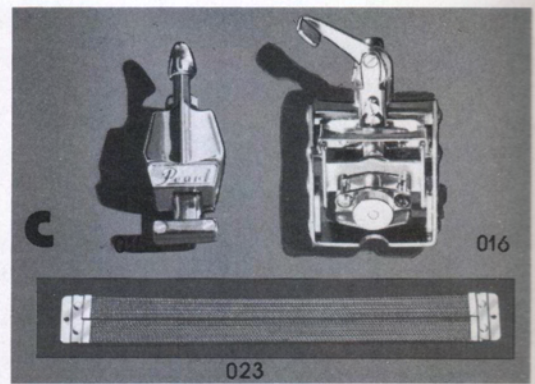
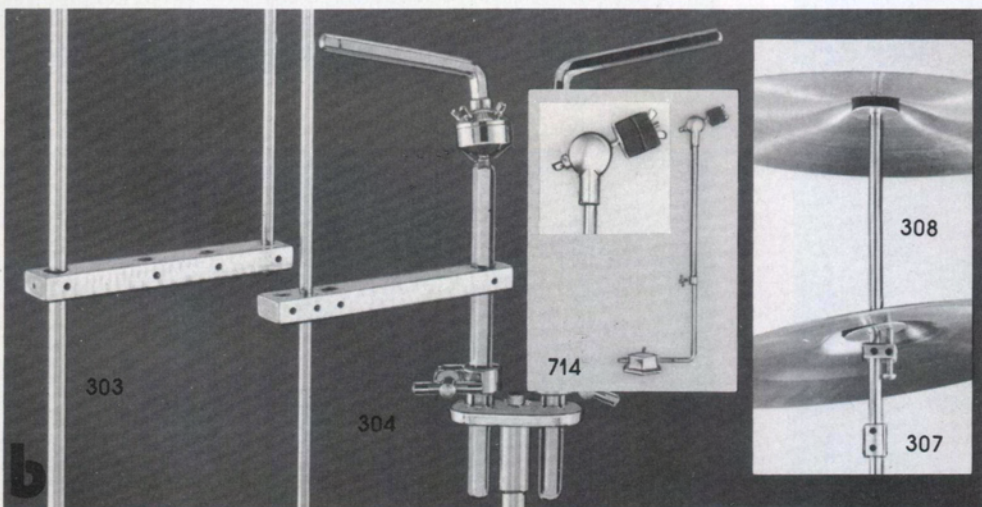
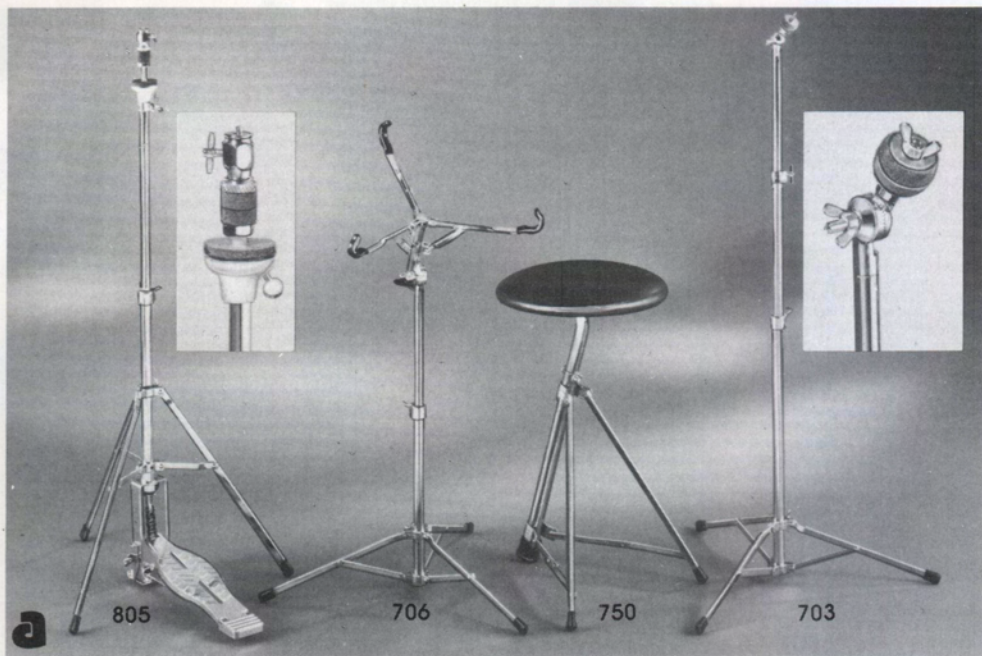

Rims and Hoops Snare drum rims for all Pearl 14" snare drums are 8 or 10-hole, heavily chrome-plated, triple flanged for accurate seating of heads and crisp rim shots. Bass drum hoops are chrome-plated with Pearl inlay to match bass drum.

Snare Drum Rims 148S-14" Snare side ■ 148B-14" Batter side ■ 1410S-14" Snare side ■ 1410B-14" Batter side

Concert Rims 064TT-6" Rim-4 holes ■ 084TT-8" Rim-4 holes ■ 106TT-10" Rim-6 holes ■ 158TT-15" Rim-8 holes

Tom-Tom Rims 126TT-12" rim-6 holes ■ 136TT-13" Rim-6 holes ■ 146TT-14" Rim-6 holes ■ 168TT-16" Rim-8 holes ■ 188TT-18" Rim-8 holes

Bass Drum Hoops 18B-18" Metal Hoop ■ 20B-20" Metal Hoop ■ 22B-22" Metal Hoop ■ 24B-24" Metal Hoop

a

805 Deluxe Hi-Hat Stand: direct chain pull, sturdy tripod base and bottom cymbal tilter ■ **706 Deluxe Share Drum Stand:** Sanson-type, locks in any playing position ■ **750 Deluxe Throne:** Rocket-type, easy and positive height adjustment ■ **703 Deluxe Cymbal Stand:** Positive locking height adjustment and multi-position tilter

b

303 Cymbal mount for Pearl tom holder ■ **304** Cymbal mount for Pearl concert tom stand ■ **714** Cymbal arm with professional tilter ■ **308** Bottom tilting cymbal holder ■ **307** rod converts 803 stand to hold two cymbals

c

015 Strainer: Gladstone-type throw off strainer complete with back side ■ **016 Strainer:** Jupiter-type with adjustable back side and interior connecting rod ■ **023 Snare:** 20 strand for Jupiter Not illustrated: **022** 20 strand for 015 strainer

d

310 Rock-Lok: newly designed; heavy-duty; toe-activated release and lock holds pedal board down to keep cymbals together for today's sound; a must for the double bass drum player ■ **709 Deluxe Bass Drum Pedal;** speedy double spring action

accessories

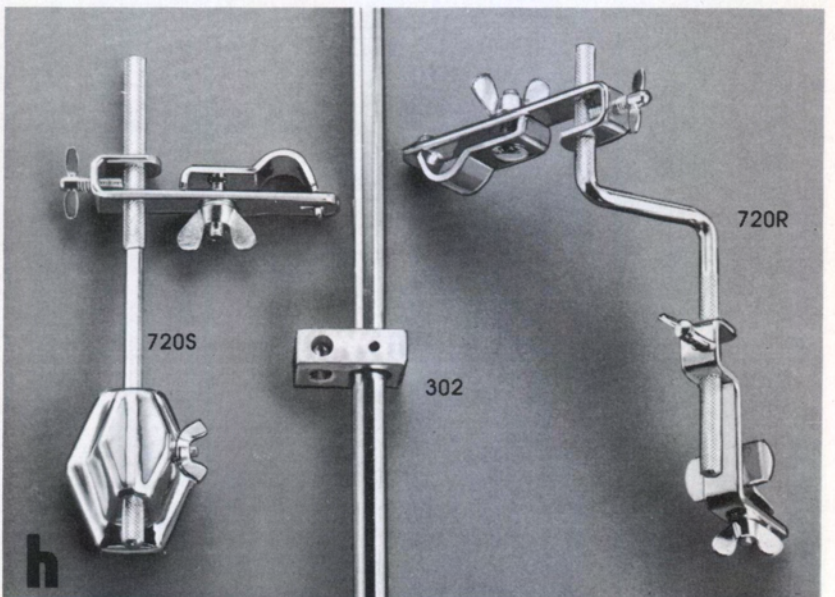
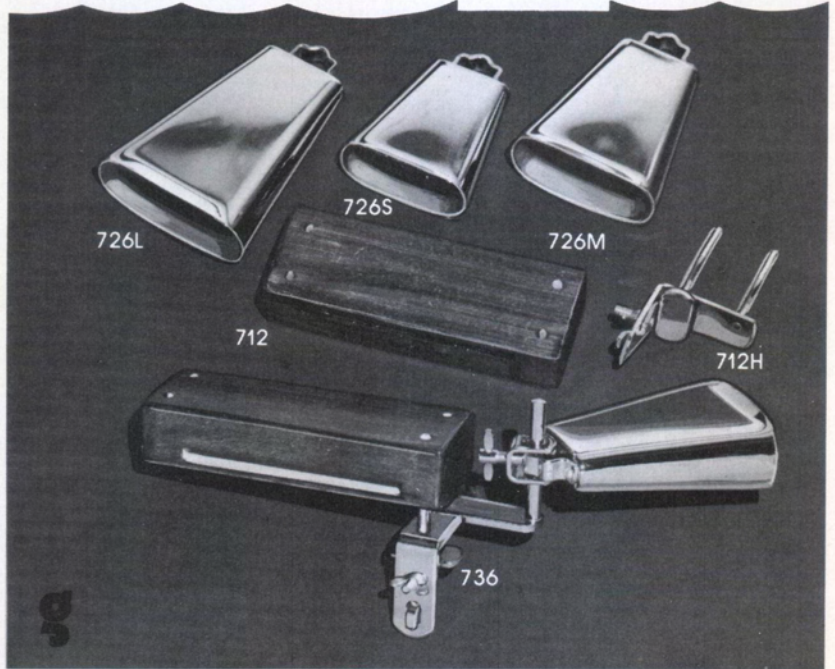
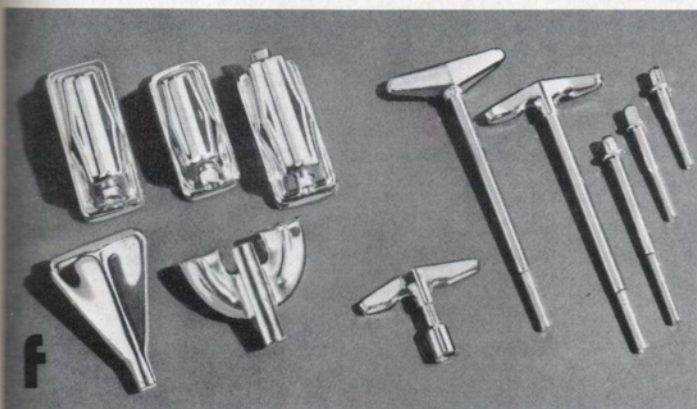
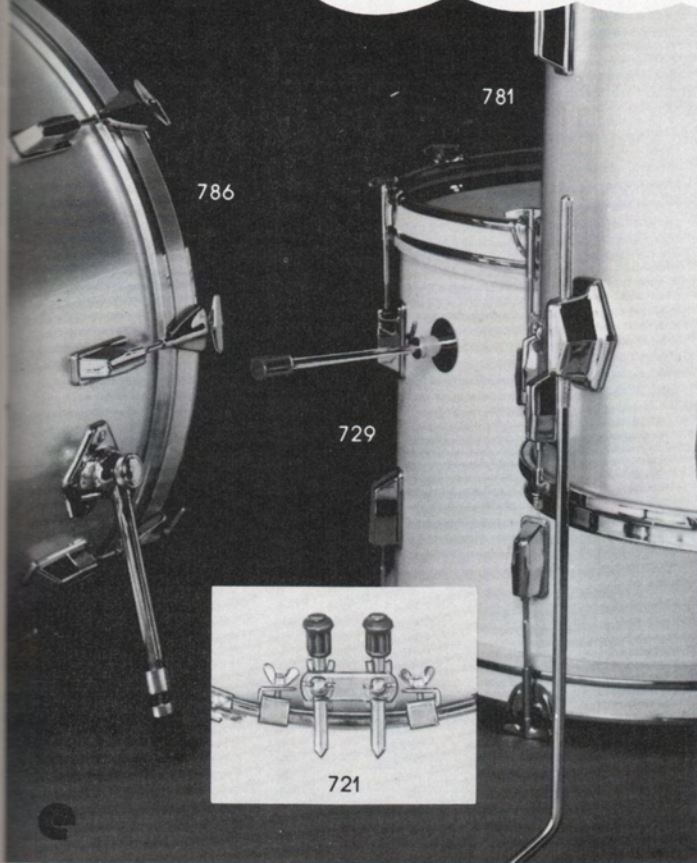

e

786 Professional Spurs: over twice the diameter of standard spurs; quick positive locking; fully adjustable ■ **729 Telescopic Spurs:** with bass drum mounting brackets ■ **781 Tom-Tom Legs:** bent shaped with unique no-slip locking device ■ **721 Bass Drum Anchor:** with reversible spurs

f

(left to right)
C-054 Large Tension Casing ■ **C-052 Small** ■ **C-053 Medium** ■ **T-078 and T-065 "T" Handle Rods** ■ **T-063, T-061, T-060 Drum Key Rods** ■ **D-035 Deluxe Hook** ■ **D-031 Standard Hook**

g

726L 6" Cowbell ■ **726M 5"** ■ **726S 4"**; chrome finish with holder ■ **726H holder only** ■ **712 Woodblock with Holder** ■ **712H Holder Only** ■ **736 Bell/Block Set:** 5" cowbell with holder ■ **736H holder only**

h

720S Shell Mount: hi-hat to bass drum attachment ■ **302 Heavy-duty block:** hi-hat to bass drum attachment ■ **720R Rim Mount:** hi-hat to bass drum attachment



"Z" SETUPS

'Z' setups are hand selected and matched cymbal setups prepackaged and color-coded at the factory.

Z-1 BASIC SETUP

2-14" New Beat Hi-Hats
1-20" Ride

This specially matched setup of 3 Avedis Zildjian cymbals is designed to provide the drummer with a basic cymbal setup for all types of music.

Z-2 MINI-CUP SETUP

2-13" Mini Hi-Hats
1-16" Mini-Cup Crash
1-20" Mini-Cup Ride

The Mini-Cup setup of 4 matched cymbals is for fine cymbal sound without spread or buildup in overtones. For high pitched tone quality and tight stick sound this is the setup. Ideal for recording and small group playing.

Z-3 ROCK SETUP

2-14" Rock Hi-Hats
1-18" Rock Crash
1-20" Rock Ride

The specially selected Rock setup of 4 carefully matched Avedis Zildjian Cymbals is for the rock drummer who wants the solid, Hi-Hat beat, dynamic ride sound and the explosive crash power needed to cut through the heavy amplification so often prevalent in today's music.

Z-4 BIG BAND SETUP

2-14" New Beat Hi-Hats
1-18" Thin Crash
1-18" Medium Thin
Crash Ride
1-20" Medium Ride

The Avedis Zildjian Big Band setup of 5 selected and matched cymbals outfits the drummer with the complete assortment of cymbals required for the all-out power needed to drive a big band. At the same time, it equips him with a wide range of cymbal sounds.

Z-5 HARD ROCK SETUP

2-15" Rock Hi-Hats
1-17" Rock Crash
1-19" Rock Crash
1-21" Rock 21

The ultimate setup for the hard rock drummer. Big and solid Hi-Hat beat combined with a duo of blazing crash cymbals and the radically new, fast moving Avedis Zildjian design for rockers...Rock 21. Dynamite!

When ordering, consult weight tables and specify SIZE, WEIGHT, and TYPE. Hi-Hat and Hand Cymbals are always shipped in factory matched pairs.

MODEL	SIZE	MODEL	SIZE	MODEL	SIZE
Z-6	6"	Z-16	16"	Z-22	22"
Z-8	8"	Z-17	17"	Z-24	24"
Z-10	10"	Z-18	18"	Z-25	25"
Z-12	12"	Z-19	19"	Z-26	26"
Z-13	13"	Z-20	20"	Z-28	28"
Z-14	14"	Z-21	21"	Z-30	30"
Z-15	15"				



ZIL-BEL COW BELLS

Expert Avedis Zildjian craftsmen experimented for many years before Zil-Bel Cow Bells satisfied their own exacting standards of quality. The result is cow bells that produce clear, authentic tone for all rhythms.

HH 6" Zil-Bel Cow Bell

KK 4 1/2" Zil-Bel Cow Bell

NN Chrome single Zil-Bell Holder complete with "U" clamps and wing nut

MM Chrome double Zil-Bell Holder complete with "U" clamps and wing nut

ZIL-BEL CYMBAL SNAPS (SS)

Can't be topped for fast and easy setup. Fool-proof, spring controlled snap top. Snap up to place or remove cymbal. Snap down to play. These handy snaps completely eliminate the inconvenience of old fashioned wing nuts. Chrome plated.

SIZZLE RIVETS (GG)

Made of nickel-plated steel for the finest sizzle sound. Excellent for replacement or for converting Avedis Zildjian Dance Cymbals to Sizzles.

Splash Cymbals: Also called "Choke" Cymbals. Small cymbals 7" to 11" in diameter and usually thin in weight. Used for fast cymbal crash work and can be choked off very quickly ■ **Crash Cymbals:** Thin or medium-thin cymbals, usually 14" to 18" in diameter and struck one or more consecutive times to accent the beat ■ **Crash Ride Cymbals:** Usually medium-thin in weight, run 16" to 22" in diameter. Suitable for both crash work and sustained ride cymbal playing ■ **Ride (Bounce Top or Rock) Cymbals:** Usually 18" to 24" in diameter in various weights. Especially made to carry a sustained beat. Mini-Cup Ride Cymbals, available in 18" and 20" sizes only. Medium-heavy to heavy in weight, are very

high pitched and have virtually no build-up in overtones. ■ **Sizzle Cymbals:** Ride or Crash Ride Cymbals, 18" to 20" in diameter, in which holes are drilled and rivets installed to give a sizzling or buzzing type of cymbal sound. ■ **Swish Cymbals:** 18" to 22" in diameter with turned up edges. "Chinese" tonal characteristics. Rivets usually installed for a more sustained effect. ■ **Ping (Ping Ride, Be-Bop) Cymbals:** Ride Cymbals 18" to 24" in diameter. Medium-heavy to heavy in weight. Made to control overtones so they don't overpower stick sound. ■ **Hi-Hat (Sock After-Beat) Cymbals:** Two cymbals 12" to 16" in diameter mounted one above the other on a cymbal stand controlled by a foot pedal. Factory

cymbals

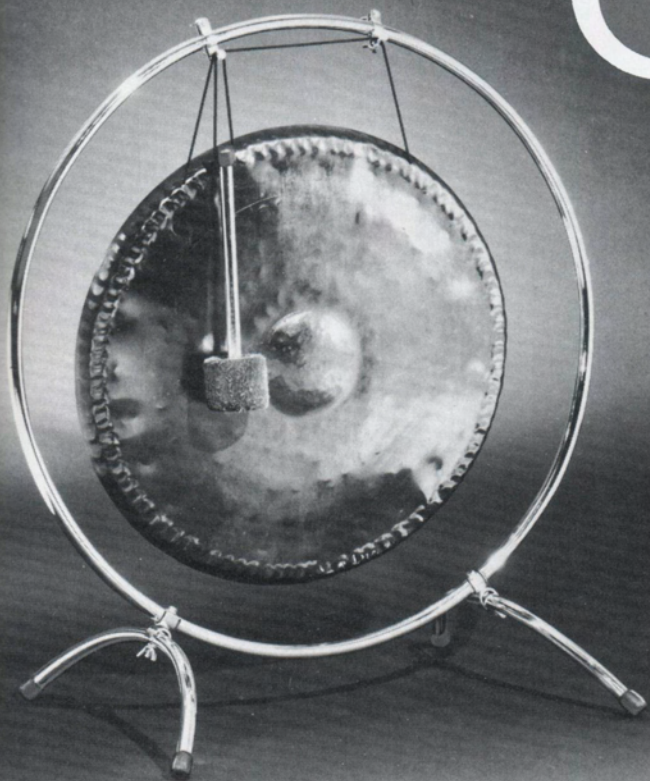

Pearl Tam-Tams

In creating this series of Tam-Tams, Pearl has recaptured the legendary Su-Chou sound, the long lost secret of the gong maker's art. Complete with sturdy circular stands and heavy mallet.

PT22 22" diameter	PT32 32" diameter
PT24 24" diameter	PT36 36" diameter
PT26 26" diameter	PT40 40" diameter
PT28 28" diameter	PTM Tam-Tam Mallet only

Tosco Cymbals

A new sound! These cymbals produce today's sounds, take the punishment of today's players, and are built by old world craftsmen with generations of cymbalsmith experience. Acclaimed by leading players, Tosco cymbals complement Pearl's Deluxe and Pro Jazz Rock outfits.

- T14** Hi-Hat Cymbal—14"
- T16** Crash Cymbal—16"
- T18** Crash-Ride Cymbal—18"
- T20** Ride Cymbal—20"

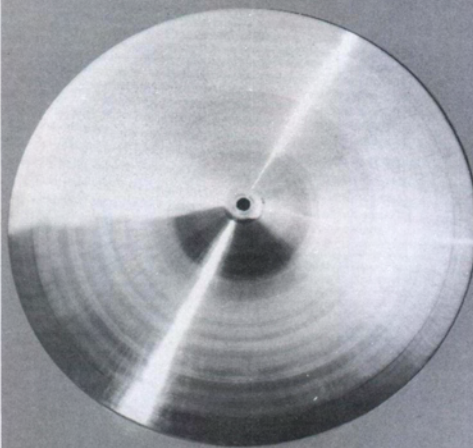
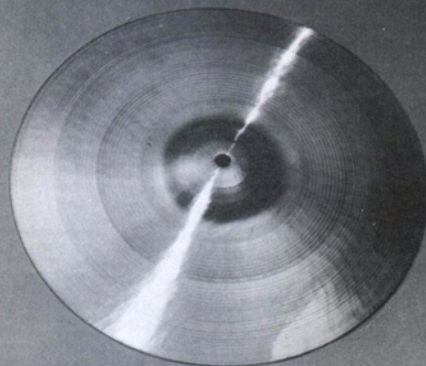

Pearl Cymbals

Pearl's spun brass cymbals are ideal for the young student. Modestly priced, they offer serious players an inexpensive setup for their practice outfits.

- 312** Hi-Hat Cymbal—12"
- 314** Hi-Hat Cymbal—14"
- 316** Crash Cymbal—16"
- 318** Crash-Ride Cymbal—18"
- 320** Ride Cymbal—20"
- 322** Ride Cymbal—22"

matched on a basis of blend of tone and "chip" sound. Regular weights: medium-thin to medium top and bottom. Weight combinations are available. ■ **New Beat Hi-Hats:** A special combination of a medium top cymbal carefully matched with a heavy bottom for intensified "chip" sound, extremely fast response, powerful projection and pin-point definition preferred by the vast majority of modern drummers. ■ **Band Cymbals:** Matched hand cymbals, medium, medium-heavy and heavy in weight, usually 14" to 18" in diameter and played with straps and pads. Grommeted for added protection against strap wear. ■ **Drum Corps Cymbals:** Similar to Band Cymbals except sometimes heavier

and often larger. ■ **Symphonic Hand Cymbals:** Paired cymbals 16" to 24" in diameter. To be equipped with straps or straps and pads (never wooden handles). Thin through heavy in weight. Three general tonal categories: (1) French, thin to medium-thin/Ssswish attack; (2) Viennese, medium to medium-heavy/Zzzing attack; (3) Germanic (or Wagnerian), heavy/K-lang attack. ■ **Concert Band Cymbals:** Similar to Symphonic Hand Cymbals except sometimes heavier in weight. ■ **Suspended Cymbals:** Selected cymbals suspended or mounted in various ways. Played with sticks or mallets. 15" to 22" in diameter. Thin through heavy in weight.

Cases



3522



1210



1480



1650



1110

1490 Cymbal Caddy Carry as many as 10 cymbals safely and securely in this fiber case—the same strong material used in drum cases. A steel center peg firmly holds up to 10 cymbals (maximum diameter 22") and still leaves room for accessories. Steel reinforced corners with two wrap-around straps.

3522 Cymbal Pouch This convenient carrying pouch for cymbals is made of Naugahyde and has a sturdy zipper. Bottom protected with covered fiber to prevent cymbals from cutting material. Features inside pocket for extra equipment. Holds cymbals up to 22" in diameter.

1650 Stick Bag Naugahyde stick and mallet bag attaches to tom-tom or mallet instrument while playing to keep your gear handy. Features extra sturdy elastic straps, strong zipper and extra gadget pockets inside and out.

Snare Drums

514 5" x 14" **614** 6½" x 14"

Tom-Toms

812 8" x 12" **913** 9" x 13" **1014** 10" x 14"

1414 14" x 14" **1616** 16" x 16" **1618** 16" x 18"

Bass Drums

1418 14" x 18" **1420** 14" x 20" **1422** 14" x 22"

1424 14" x 24"

1480 King Size Trap Case Protects your snare drum in a separate foam lined compartment. Other roomy compartments hold a throne, two pedals, plenty of cymbals up to 22" with even more room for stands in the large accessory tray. Large 3" rubber casters. Features metal reinforced fiber, steel corner plates, folding heavy-duty chest handles, longer side brackets on accessory tray and webbed handles for easier tray pull out. Dimensions: 23"H x 15"W x 24½"L.

1442 Pax-All Trap Case 16" foam lined partition for snare drum plus a 7" partition for accessories. Three handles for easier carrying and wide straps for secure closing. Dimensions: 23"L x 10"W x 21"D. Tray is 22"L x 9"W x 5"D.

1460 Carry-All Trap Case Partitioned to hold snare drum and cymbals up to 22". Foam-lined snare drum compartment. Three heavy-duty handles and wide wraparound straps. Dimensions: 22¼"L x 11"W x 22¼"D. Tray is 21⅞"L x 9¼"W x 7"D.

1460W Carry-All Trap Case With wheels.

1465 Standard Fiber Snare Drum Case For use with any size snare drum. ½" foam rubber lining compartments and flaps to hold drum securely. Dimensions: 23"L x 16½"W x 10"D.

Bass Drum Cases All bass drum cases have the standard comfort grip handles on top plus two chest handles on sides for easier carrying. Three wide straps positioned for secure closing of deep lipped cover.

1108 14" x 18"

1109 14" x 20"

1110 14" x 22"

1117 14" x 24"

Tom-Tom Cases All tom-tom cases have ¼" foam lining top and bottom to protect your drums. Multiple straps on larger sizes for securely fastening on the deep lipped covers which accommodate throne seats.

1408 8" x 12"

1409 9" x 13"

1412 10" x 14"

1410 14" x 14"

1411 16" x 16"

1414 16" x 18"

1413 18" x 20"

1289 Combination case for 8" x 12" and 14" x 14"

1416 Combination case for 9" x 13" and 16" x 16"

1290 Combination case for 8" x 12" and 9" x 13"

1291 Combination case for 9" x 13" and 10" x 14"

P479 Samson Kit Case An attractively stitched kit case with slanted side compartments for stand and accessories designed for standard 5½" x 14" snare drum. Metal valance, plated locks and durable hinges protect contents.

Pearl's jet black covers are made with plyhide. It's a thick plastic material that's waterproof, weatherproof, and almost impossible to tear. The zippers are extra strong, and the plyhide's attractive leather grain never wrinkles.

Pearl's Fibre drum cases are constructed of heavy, vinyl-coated board that's chemically treated and completely moisturized for the best possible protection. All joints are riveted and the extra wide, multiple straps with large buckles add even more protection. Foam rubber is selectively applied inside to cushion your drums and protect the rims.

Your Pearl Drums are the best. So, give them the protection they deserve with Pearl covers and cases.

How to Order Covers & Cases—Covers and cases are made with allowance for lugs, rods and counter hoops. Measure across head inside of hoop. Measure shell height from one head surface. Always give shell size only.

sticks



Descriptions below start with stick on top of page, and are in order as you move down.

Hickory: Louie Bellson—15⁷/₈" ■ Shelly Manne—15¹/₈" ■ Jake Hanna—16" ■ Larrie Londin—16¹/₈"—nylon tip

Oak: 1A Ed Shaughnessy—16" ■ 3A Ed Shaughnessy—16¹/₈" ■ 5A Ed Shaughnessy—16" ■ 7A—15¹/₂" ■ 8A—15³/₈" ■ 5A Ed Shaughnessy—16"—nylon tip ■ 7A Ed Shaughnessy—15¹/₂"—nylon tip ■ 2B—15⁷/₈" ■ 5B—16¹/₈" ■ 5B—16¹/₈"—nylon tip ■ 1S—16⁷/₈" ■ 2S—16³/₄" ■ 3S—17" ■ 1S—16⁷/₈"—nylon tip ■ 2S—16³/₄"—nylon tip ■ Rock 105—16¹/₈" ■ Rock Knocker—16" ■ JR Ed Shaughnessy—16¹/₈" ■ JR Ed Shaughnessy—16¹/₈"—nylon tip

Beaters: 709-1 Black. Hard felt, ball end beater. ■ 810-1 White. Hard felt, ball end beater ■ WB-1 Wooden ball end beater.

Pearl sticks were designed to meet every playing situation. Selected models are available in white oak or hickory—plain wood or nylon tips. The Louie Bellson, Jake Hanna, Larrie Londin, Shelly Manne and Ed Shaughnessy signature sticks are the actual models these artists play and record with. And, if that's not enough, Pearl's got a lot more to choose from.

Pearl by Weather King

	Diam.	CS Controlled Sound Heads				Coated Brushed Surface	Coated Heads			
		Smooth White Black Patch	Smooth White Transparent Patch	Transparent Black Patch	Transparent Transparent Patch		Diplomat	Diplomat M5	Ambassador	Emperor
Batter and Tom-Tom Heads	6"	R206-1	R206-2	R306-1	R306-2		106BD		106BA	106BE
	8"	R208-1	R208-2	R308-1	R308-2		108BD		108BA	108BE
	10"	R210-1	R210-2	R310-1	R310-2		110BD	110M5	110BA	110BE
	11"	R211-1	R211-2	R311-1	R311-2		111BD	111M5	111BA	111BE
	12"	R212-1	R212-2	R312-1	R312-2		112BD	112M5	112BA	112BE
	13"	R213-1	R213-2	R313-1	R313-2		113BD	113M5	113BA	113BE
	14"	R214-1	R214-2	R314-1	R314-2	R114-1	114BD	114M5	114BA	114BE
	15"	R215-1	R215-2	R315-1	R315-2		115BD	115M5	115BA	115BE
	16"	R216-1	R216-2	R316-1	R316-2		116BD	116M5	116BA	116BE
	17"	R217-1	R217-2	R317-1	R317-2		117BD	117M5	117BA	117BE
	18"	R218-1	R218-2	R318-1	R318-2		118BD	118M5	118BA	118BE
20"	R220-1	R220-2	R320-1	R320-2		120BD		120BA	120BE	
Snare Heads	12"									
	13"									
	14"									
	15"									
	16"									
	17"									
18"										
Bass Drum Heads	18"	R218B-1	R218B-2	R318B-1	R318B-2				118B	118BB
	20"	R220B-1	R220B-2	R320B-1	R320B-2				120B	120BB
	22"	R222B-1	R222B-2	R322B-1	R322B-2				122B	122BB
	24"	R224B-1	R224B-2	R324B-1	R324B-2				124B	124BB
	26"	R226B-1	R226B-2	R326B-1	R326B-2				126B	126BB
	28"	R228B-1	R228B-2	R328B-1	R328B-2				128B	128BB
	30"	R230B-1	R230B-2	R330B-1	R330B-2				130B	130BB
	32"	R232B-1	R232B-2	R332B-1	R332B-2				132B	132BB
	34"	R234B-1	R234B-2	R334B-1	R334B-2				134B	134BB
	36"	R236B-1	R236B-2	R336B-1	R336B-2				136B	136BB
40"	R240B-1	R240B-2	R340B-1	R340B-2				140B	140BB	

Pearl Drum Heads are a product of Remo, Inc.—world's largest manufacturer of quality percussion accessories. Made to the same exacting specifications as Remo's Weather King heads, Pearl offers the most popular sizes, weights and types used by more of today's leading players. A Pearl head will make any drum sound better, and there's a type to fit your own particular and distinctive sound requirements.

"CS" Controlled Sound Drum Heads The "CS" sound center reinforcement dampens most of the overtones, while the fundamental drum tone comes through loud and clear. The result is a centered drum sound without any annoying

"overring." It's great for recording any kind of music or for marching percussion, combining thin head response with parade head durability.

Coated Heads The exclusive, long lasting, coated surface gives a crisp brush and stick response for the life of the head. Choose from three weights—the heavy Emperor, the Ambassador or the Diplomat, plus the very thin Diplomat M5 heads specially developed for sensitive orchestra percussion. Bass drum heads furnished in either Ambassador or heavy-duty Emperor weights.

Smooth White Heads The Smooth White heads are ideal

heads

Smooth White Heads			Transparent Heads			FiberSkyn Heads	Sound Master Heads
Diplomat	Ambassador	Emperor	Diplomat	Ambassador	Emperor		
206BD	206BA	206BE	306BD	306BA	306BE	506	
208BD	208BA	208BE	308BD	308BA	308BE	508	
210BD	210BA	210BE	310BD	310BA	310BE	510	
211BD	211BA	211BE	311BD	311BA	311BE	511	
212BD	212BA	212BE	312BD	312BA	312BE	512	12BO
213BD	213BA	213BE	313BD	313BA	313BE	513	13BO
414BD	414BA	414BE	314BD	314BA	314BE	514	14BO
215BD	215BA	215BE	315BD	315BA	315BE	515	15BO
216BD	216BA	216BE	316BD	316BA	316BE	516	16BO
217BD	217BA	217BE	317BD	317BA	317BE	517	
218BD	218BA	218BE	318BD	318BA	318BE	518	
220BD	220BA	220BE	320BD	320BA	320BE	520	
			112SD	112SA	112SE		
			113SD	113SA	113SE		
			114SD	114SA	114SE		14SO
			115SD	115SA	115SE		15SO
			116SD	116SA	116SE		
			117DS	117SA	117SE		
			118SD	118SA	118SE		
	218B	218BB		318B	318BB	518B	18SMB
	220B	220BB		320B	320BB	520B	20SMB
	222B	222BB		322B	322BB	522B	22SMB
	224B	224BB		324B	324BB	524B	24SMB
	226B	226BB		326B	326BB	526B	
	228B	228BB		328B	328BB	528B	
	230B	230BB		330B	330BB	530B	
	232B	232BB				532B	
	234B	234BB				534B	
	236B	236BB				536B	
	240B	240BB				540B	

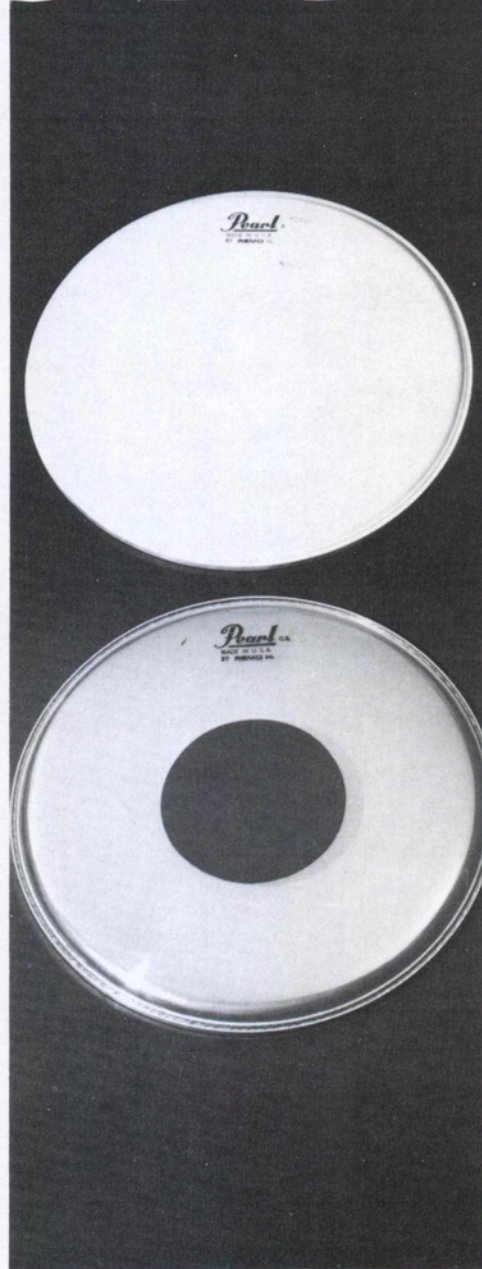

for tom-toms, marching drums or wherever a coated surface is not required. The white surface can be cleaned with a damp cloth. Available in three weights including the heavy-duty heads with improved pull-out protection for drum corps use.

Transparent Heads Get the see-through look with Pearl's transparent heads. Rock bands as well as marching units especially like the medium Ambassador and heavy-duty Emperor head weights. Or, if you've got a sensitive touch, try the Diplomat.

Transparent Snare Side Heads Choose from three

weights ranging from the thin Diplomat to the heavy-duty Emperor.

FiberSkyn Heads A revolutionary head that gives you a "calf-like" sound. The FiberSkyn is a fiberglass-Mylar laminate made with a new special process. It's a whole new concept in drum heads.

Sound Master Heads These heads were designed with functional economy in mind. They're constructed with a strong, weatherproof, plastic with reinforced epoxy hoops so you get a fine sounding performance at a surprisingly low price.

practice pads

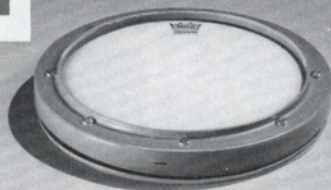

Tuneable Drum Practice Pads
RT6 6" Diameter
RT8 8" Diameter
RT10 10" Diameter

Drum Practice Sets

RPS10 Standard Set:

6" pad (bass drum),
 8" pad (tom-tom),
 Two 10" pads (snare and
 floor tom-tom), center
 support assembly
 and extension arms.

RPS10T Twin

Tom-Tom Set:

Identical to RPS10
 with one additional
 8" pad for twin tom
 setup. Complete with
 all extension arms
 and support rods.

RPS10D Twin Bass Drum Set: Identical to RPS10 with one
 additional 6" pad with separate base plate and center
 support for two bass drum setup.

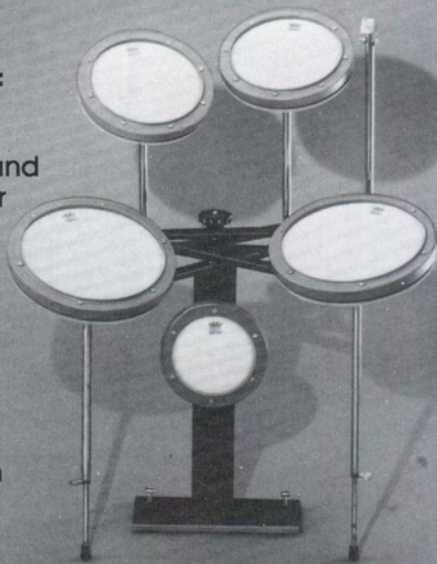

Drum Practice Sets — Replacement Parts

PS105 Post control knob ■ **PS108** 3/8" chrome rod leg support ■ **PS110**
 Anodized base plate ■ **PS111** Anodized center column ■ **PS113** 18"
 Anodized arm ■ **PS114** 12" Anodized arm ■ **PS117** Chrome tube and
 tilter assembly for small tom-toms ■ **PS118** Chrome tube and tilter
 cymbal assembly ■ **PS119** Chrome snare drum or large tom-tom
 tube and tilter assembly, with steel rod, crutch tip and thumb screw



CS RotoToms

Furnished with transparent head and
 black sound center. Stands not included.

RR6 6" Diameter

RR14 14" Diameter

RR8 8" Diameter

RR16 16" Diameter

RR10 10" Diameter

RR18 18" Diameter

RR12 12" Diameter

RotoTom Stands

102RT Single Drum; 6"–12"; Light-weight

103RT Single Drum; 6"–18"; Heavy-duty

104RT Double Drums; Any 2 sized Roto-
 Toms; Heavy-duty

Timpani RotoToms

Extended range for each RotoTom is a full
 octave or more. Stands not included.

RR6T 6"; e¹/c²

RR14T 14"; G/e

RR8T 8"; g/e¹

RR16T 16"; F/d

RR10T 10"; c/a

RR18T 18"; E/c#

RR12T 12"; B/g

Tuneable Practice Pads give you a true drum feel without
 the excessive drum sound. Play the edges, play the
 centers, or play the entire drum surface. You can hear all
 the differences in dynamics, when you play loud and soft.
 The practice pads are complete with tensioning key, war-
 ranty and an instruction booklet.

The versatile Drum Practice Sets are the choice of leading
 professionals like Louie Bellson. You can recreate the exact
 feel of your own drum set because each rugged practice
 set is fully adjustable.

Newly designed Roto-Toms offer an extremely wide range
 from bongo to timpani. Simply rotate the drum to tune it.
 The new cast aluminum tension support frame gives
 rugged strength plus a free flow of sound.

Latin American



FN210 Quinto—10" diameter
FN211 Conga—11" diameter
FN212 Tumba—12" diameter
Available in Black or White
Fiberglass body; chrome-plated hardware



B213 Timbales (6½" x 14" and 6½" x 13"); chrome-plated brass shells; includes 6½" cowbell with holder, sticks and stand.



J1 Jingle Shaker; multi-percussive unit; includes beater and vinyl carrying case.

Pearl has accurately proportioned the head-to-belly taper of the Quinto, Conga and Tumba to give them an authentic Latin American sound. And they project more of that sound because of their sturdy fiberglass construction. The legs adjust to the exact height you need.

Pearl's Timbale has a sturdy non-slip stand that adjusts to your favorite height. The brass, chrome-plated shell gives you the best possible sound. Complete with cowbell, holder and sticks.

Pearl's Jingle Shaker gives you the shaker, the guiro and the tamborine all in one. And it's one better because you can play all three sounds at once. It's perfect for percussionists as well as lead singers who have their hands free.

If you're into the multi-rhythmical Latin American sound, then get the most authentic Latin American instruments—from Pearl.

clinicians

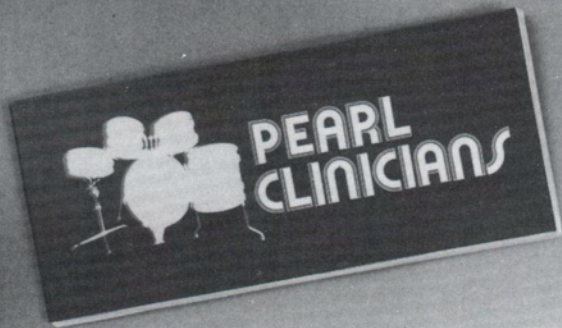

Pearl has put together the greatest collection of clinicians ever.

Every Pearl artist combines a fresh, contemporary approach with a superb musical performance to make each clinic a memorable and meaningful presentation. Each clinician is an acknowledged leader in his field. And there's a complete selection of musical styles so you can choose the artist that's perfect for your particular need. Your group will observe the results of proper playing techniques with Pearl's excellent staff of clinicians.

Complete details on Pearl artists are available to educational organizations, institutions and authorized Pearl dealers. Pearl clinics and concerts are always as entertaining as they are enlightening. Let Pearl help you put your next clinic together. Send for your copy of "Pearl Clinicians" today.

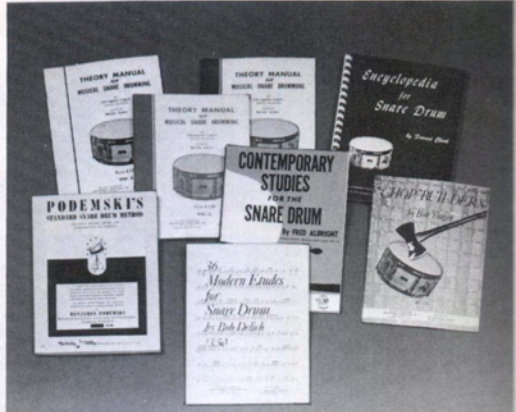

Podemski's Standard Snare Drum Method by Benjamin Podemski—Rudiments and drum technique, plus reading for concert band and orchestra.

36 Modern Etudes For Snare Drum by Bob Delich—These drum compositions cover every exercise angle.

Contemporary Studies For The Snare Drum by Fred Albright—The advanced drummer who already knows the rudiments will advance even further in sight reading ability and technique.

Chop Builders by Bob Yaeger—New variations of the 26 standard American and French rudiments.

Encyclopedia For Snare Drum by Forrest Clark—A complete compilation of rhythmical exercises by a leading percussionist.

Theory Manual Of Musical Snare Drumming—Three Volumes by D'Artagnan Liagre—A detailed weekly course, complete with theories, examples and exercises.



Belwin Mills Reference Guide—Piano teaching, Hawaiian guitar courses, percussion solos, musical plays, etc.

MCA Music Catalog—Catalog offers arrangements for everything from piano to vocal.

Marks Music Reference Guide—Music by Brahms, George M. Cohan, Billie Holiday, Chopin, Stephen Foster and more for piano, electronic organ, chorus and still more.



Latin Sounds From The Drum Set by Frank "Chico" Guerrero—Cuban and Brazilian rhythms and Latin instruments are covered.

The New Time Signatures In Jazz Drumming by Ed Shaughnessy—Varied time signatures of modern jazz are outlined for the entire drum set.

Odd Times by Joe Porcaro—A new approach to Latin, jazz and rock applied to the drum set.

The Contemporary Percussionist by Charles Memphis—Rapidly changing time signatures and exercises in modern set technique.

Modern Jazz Solos For The Drum Set by Colin Bailey—Comprehensive studies develop knowledge of the drum set.

Latin Guide For Drummers by John Rae—Basic Latin rhythms with explanatory material.

Bass Drum Control by Colin Bailey—Written to master the bass drum and use it to its fullest extent.

Pearl is very active in the percussion clinician field and offers a unique approach to educational clinics and fund raising concerts through the widely diversified talents of those fine players using Pearl Drums.

Pearl's artists are highly qualified players, covering virtually every style of today's music. Rock, jazz-rock, jazz, combo, country & western, pop, studio, big band...all fields are represented by the most respected names associated with the particular style:

Louie Bellson
Brent Brace
Chick Colburn
Art Blakey
Richard Brown

John Drase
Larrie Londin
Les DeMerle
Candy Finch
Shelly Manne

Bill Nawrocki
Ed Shaughnessy
Mark Stevens
Vinnie Ruggiero
Jack Spurling

Each is a specialist in his own style. Write for our free clinician brochure outlining the content of a variety of clinic presentations. Pearl can match the right clinician with the topic you want covered.

publications



All Kinds Of Rock by Jim Engle—Unique design lets you group 159 different drum patterns into any combination of three that you want.

Rock 'n Time—Fills and Solos by Jim Engle—Rock, Latin-rock, jazz-rock, folk-rock, gospel-rock, bossa-rock, and more.

Jazz Rock Fusion by Les DeMerle—The product of a three year project exposes the dynamics of high-energy jazz drumming.

Rock Jazz Phrasing For The Advanced Drummer by Henry Bellson—This fine drummer and teacher instructs the student while leaving room for the student's own ideas and interpretations.

Manual Of Rock Drumming by Ken Babal—Gives the reader a basis for creativity and teaches co-ordinated independence of hands and feet.

Modern Reading Text In 4/4 by Louis Bellson in collaboration with Gil Breines—Syncopation studies designed to develop accuracy and speed in sight reading.

Louis Bellson's Jazz Rock Beats—Contemporary rhythms, nu-to-sonic rhythms, a duet for two players—all by the legendary innovator.

Progressive Studies For Double Bass Drums by Louis Bellson—The first and foremost drummer to use two bass drums helps the reader master the art with these comprehensive studies.

Louis Bellson's Introduction To Percussion—Vol. I—A comprehensive guide to writing and playing for the percussion section.

Odd Time Reading Text For All Instruments by Louis Bellson and Gil Breines—Rhythmic studies designed to develop accuracy and speed in sight reading applied to odd time signatures.



Independence For The Beginner—Volumes I and II by Charles Flores—Designed to develop greater flexibility.

Syncopated Big Band Figures Solos—Vol. I; Duets—Vol. II by Jake Hanna—Exercises to boost your reading/playing abilities for big band applications.

Elementary Drum Method by Roy Burns—Easy to understand explanations of everything from drum care to rudimental studies.

A Modern Approach To Independence For The Advanced Drummer by Nick Ceroli—Rhythms to develop contrapuntal independence.

Introduction To The Drum Set by Charles Perry—Learn your way around the drum set in jazz form drumming.

Elementary Method of Drumming by Nat Leslie—A great help from how to buy an instrument to how to play it.



Musician's Guide To Polyrythms—Vol. II by Pete Magadini—Learn to play the polyrhythmic music of Africa and India.

Portraits In Rhythms by Anthony J. Cirone—Unusual meters, shifting bar-lines and irregular phrases for intermediate and advanced.

Time On Time Divided By Time by Brent Brace—Putting signatures together to make phrases of different signatures work as one.

Music Educators' Guide To Percussion by Al Payson and Jack McKenzie—Everything you need to know about every percussion instrument.

Rhythm Patterns For The Modern Drummer by Joe Cusatis—Helps modern jazz drummers develop a better knowledge in playing the drums.



Helping Pearl put it all together...and keep it all together...are some of the most respected names in the music business. Owners of "Percussion Only" shops, these specialists are in daily touch with the finest players in the world...their customers. To keep ahead of the ever changing and varied trends coast to coast, Pearl depends on such experts as our advisor, Bob Yeager (Professional Drum Shop, Hollywood, California), "Pearl has put it all together. I have never seen finer quality drums and accessories."

... Morrie Lishon (Franks Drum Shop, Chicago, Illinois), "In my opinion, your product has fulfilled all the promises predicted several years ago when Franks Drum Shop originally introduced Pearl Drums to the Midwest. Keep up the good work..."and Frank Ippolito (Professional Percussion Center, New York, New York), "I find that Pearl Drums and accessories meet the high standards that both my customers and I demand."

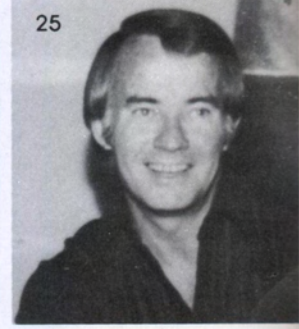
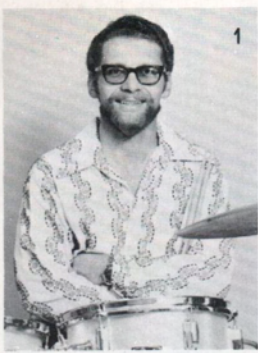

Pearl artists...

- 1. Dick Allen
- 2. Ken Allen
- 3. Dennis Alexander
- 4. Sonny Babbidge
- 5. Mike Baird
- 6. Duke Barrett

- 7. Dave Bedell
- 8. Mike Berkowitz
- 9. Brent Brace
- 10. Rich Brown
- 11. Eddie Burrell
- 12. Joe Buerger

- 13. Frankie Chavez
- 14. Peter Criss
- 15. Chick Colburn
- 16. Joe Corro
- 17. Lloyd Cranford
- 18. Doug Dean

- 19. Larry Dent
- 20. Denny Dixon
- 21. Bill Douglas
- 22. Dennis Dragon
- 23. John Drase
- 24. Elliot Franks
- 25. Tommy Gillen

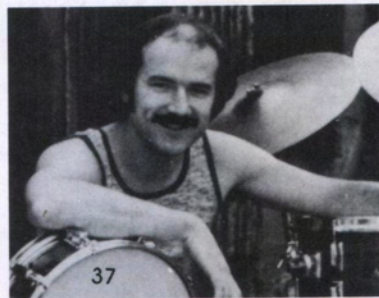
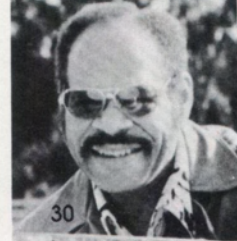
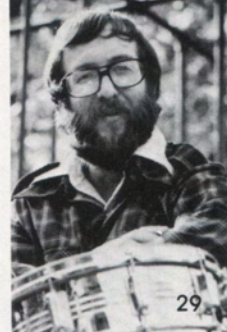
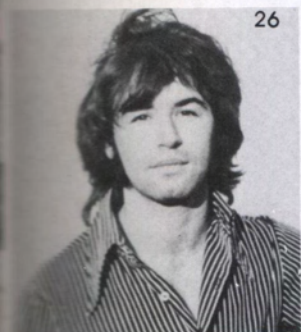
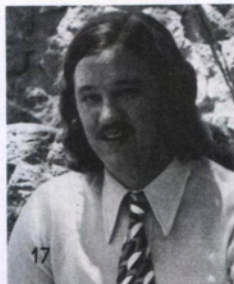

helping to put it together

- 26. Deane Hagen
- 27. John Hernandez
- 28. Joey Herrick
- 29. 'Stx' Hettleman
- 30. Dave Howard
- 31. Howard Kurban

- 32. Jan Kurtis
- 33. Pete Limonick
- 34. Omar Martinez
- 35. Carl Motola
- 36. David Page
- 37. John Perett

- 38. Wayne Phillips
- 39. Fred Pierce
- 40. Chuck Piscitello
- 41. Vinnie Ruggiero
- 42. Tommy Rundell
- 43. Neal Sausen

- 44. Johnny Sciarrino
- 45. Wally Snow
- 46. Terry Silverlight
- 47. Jim Vaughn
- 48. Peter Wolland
- 49. Bob Zimmitti

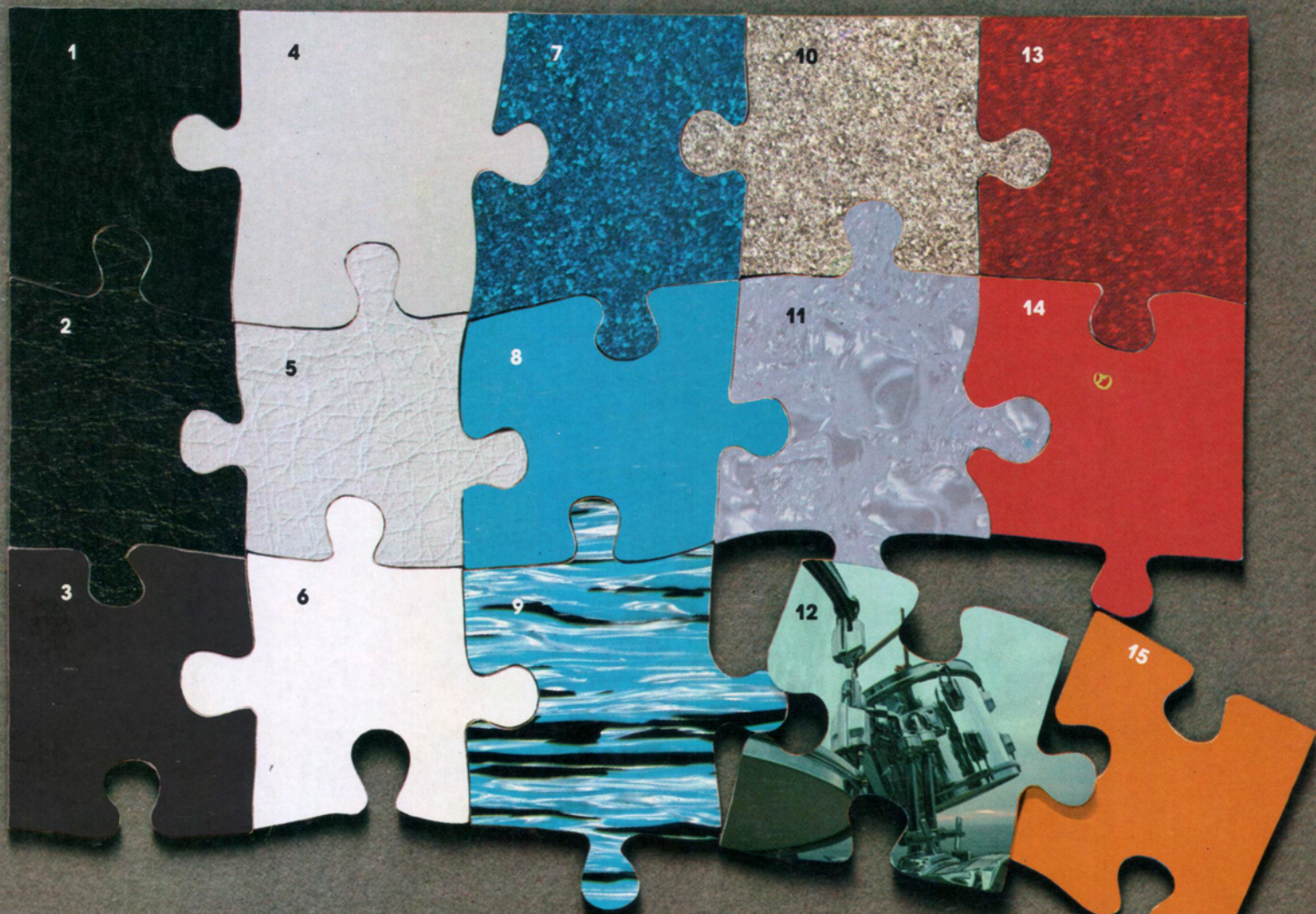

- | | | | | |
|---------------------|---------------------|----------------|-------------------|----------------|
| 1 Jet Black | 4 Silver Satin | 7 Blue Sparkle | 10 Silver Sparkle | 13 Red Sparkle |
| 2 Black Leatherette | 5 White Leatherette | 8 Blue Satin | 11 Marine Pearl | 14 Red Satin |
| 3 Black Matte | 6 Pure White | 9 Blue Oyster | 12 Chrome | 15 Gold Satin |

Available finishes shown above (Transparents not Illustrated).

Pearl
DRUMS

Distributed by Norlin Music, Inc.
7373 N. Cicero Avenue
Lincolnwood, Illinois 60646