

# Slingerland

THE FOREMOST IN DRUMS



CATALOG 65

The  
**Slingerland**

Staff—  
at Your  
Service



Warren Meyers  
Plant Manager



Don Osborne  
Sales Manager



Joe Raiche  
Eastern Sales



Al Moffatt  
Mid-Eastern Sales



John Clark  
South-Eastern Sales



John Elliott  
Office Manager



Lee Hickie  
Ill., Ind., Mich., and  
Wis. Sales



Gerry Havlacek  
Middle-West Sales



Smokey Perkins  
South Western Sales



Jack Phillips  
Cal., Nev. & Ariz. Sales

# SLINGERLAND

Slingerland Drums are guaranteed for five years against defective material or workmanship. Our plastic heads are guaranteed from pulling out, but heads cannot be guaranteed against breakage.

## HOW TO ORDER

SLINGERLAND EQUIPMENT is sold through legitimate Music Dealers only. When ordering be sure to state quantity, catalog number and description. On drum orders be sure to specify color of pearl or lacquer.

## CONCERNING DRUM HEADS

All Drums up to and including 30" diameter are supplied with Plastic Heads unless otherwise specified.

ALL SLINGERLAND DRUMS NOW COME IN TRIPLE-CHROME PLATING.

## TABLE OF CONTENTS

OF THE WORLD'S FINEST AND FASTEST SELLING DRUMS, TIMPANI AND ACCESSORIES

|                                           |        |                                             |        |                                           |                        |
|-------------------------------------------|--------|---------------------------------------------|--------|-------------------------------------------|------------------------|
| Anchors for Bass Drums.....               | 21     | Drum Kits .....                             | 26, 27 | Rain Covers .....                         | 57                     |
| Bass Drums                                |        | Drum Outfits                                |        | Repair Parts .....                        | 60, 61, 62, 63         |
| .. 22, 23, 45, 46, 47, 48, 50, 51, 52, 53 |        | ..... 4, 5, 6, 7, 8, 9, 10, 11, 12, 13      |        | Scotch Bass Drums                         |                        |
| Bass Drums, Scotch                        |        | Drummer's Chair .....                       | 30     | .. 44, 45, 46, 47, 48, 49, 50, 51, 52, 53 |                        |
| .. 44, 45, 46, 47, 48, 49, 50, 51, 52, 53 |        | Drum Stick Holder .....                     | 33     | Shrine Drums .....                        | 38                     |
| Bass Drum Stand .....                     | 21     | Effects, Sound .....                        | 64, 65 | Slings .....                              | 54                     |
| Batons .....                              | 56     | Emblems .....                               | 54     | Snare Drums .....                         | 14, 15, 16, 17, 18, 19 |
| Beaters .....                             | 41     | Gongs .....                                 | 28     | Snares .....                              | 61                     |
| Beaters, Pedal .....                      | 32     | Gourds .....                                | 25     | Sound Effects .....                       | 64, 65                 |
| Bell Lyras .....                          | 55     | Heads .....                                 | 64, 65 | Snare Strainers .....                     | 61                     |
| Bongos .....                              | 24     | Hi Hat Pedals .....                         | 30, 31 | Spurs .....                               | 21                     |
| Brushes .....                             | 39     | Hooks, Rods, Lugs .....                     | 62     | Stand, Bass Drum .....                    | 21                     |
| Bugles .....                              | 42     | Hoops .....                                 | 62     | Stand, Snare Drum .....                   | 30, 31                 |
| Carrying Hooks .....                      | 61     | Imitations .....                            | 64, 65 | Sticks .....                              | 40                     |
| Cases .....                               | 57     | Instruction Books .....                     | 58, 59 | Tambourines .....                         | 65                     |
| Cases for Bugles .....                    | 42     | Kits Drum .....                             | 26, 27 | Tenor Drums                               |                        |
| Castanets .....                           | 33     | Leg Rests .....                             | 54     | .. 44, 45, 46, 47, 48, 49, 50, 51, 52, 53 |                        |
| Claves .....                              | 25     | Lyras and Accessories .....                 | 55     | Tenor Tymps .....                         | 50                     |
| Cocktail Drums .....                      | 13     | Maracas .....                               | 25     | Thrones .....                             | 30                     |
| Congas .....                              | 25     | Maraca Sticks .....                         | 25     | Timbales .....                            | 24                     |
| Concert Snare Drums .....                 | 19     | Mackintosh Covers .....                     | 57     | Tom Toms .....                            | 18, 39                 |
| Concert Tom Toms .....                    | 39     | Mufflers, Bass Drum .....                   | 21     | Tom Tom Holders .....                     | 20, 21                 |
| Covers .....                              | 57     | Oriental Drums .....                        | 38     | Tom Tom Legs .....                        | 20                     |
| Cow Bells .....                           | 33     | Outfits... 4, 5, 6, 7, 8, 9, 10, 11, 12, 13 |        | Tone Controls .....                       | 62                     |
| Cow-bell Holders .....                    | 33     | Parade Drums                                |        | Traps and Imitations .....                | 64, 65                 |
| Cymbals .....                             | 28     | .. 44, 45, 46, 47, 48, 49, 50, 51, 52, 53   |        | Triangles .....                           | 65                     |
| Cymbal Holders .....                      | 29     | Pedal Repair Parts .....                    | 60     | Timpani .....                             | 34, 35, 36, 37         |
| Cymbal Pouches .....                      | 28     | Pedals .....                                | 32     | Whistle .....                             | 54                     |
| Cymbal Stand, Floor .....                 | 29, 30 | Plastic Heads .....                         | 65     | Wood Block Holders .....                  | 33                     |
| Cuban Congas .....                        | 25     | Practice Pads .....                         | 33     | Wood Blocks .....                         | 33                     |
| Drum Head Tucker .....                    | 64     | Practice Pad Stands .....                   | 33     | Vibraharp Mallets .....                   | 40                     |
| Drum Heads .....                          | 64, 65 |                                             |        | Zip-Lock Covers .....                     | 57                     |
| Drum Key and Holder .....                 | 63     |                                             |        |                                           |                        |



H. H. Slingerland, Jr.  
President

**Slingerland Drum Co., 6633 N. Milwaukee Ave., Niles 48, Illinois**

# *Slingerland*

**THE WORLD'S LEADING MANUFACTURER  
OF PRECISION DRUM EQUIPMENT**



## **NEW SLINGERLAND PLANT AND OFFICES THE WORLD'S LARGEST, MOST MODERN DRUM PLANT**

The Slingerland name is recognized the world over as the finest in drum equipment. Founded in 1916 by H. H. Slingerland, the Slingerland Drum Co. has grown steadily and now is the largest manufacturer of drum equipment in the world. It is the only drum firm that manufactures and processes all of its own parts exclusively—which includes skilled wood-working, metal-working, plating, finishing and final assembling.

In 1960 the Slingerland Drum Co. invested over a million dollars in a new plant and equipment so that they can supply the consumer with the highest quality drum equipment.

## **THE *Slingerland* BOARD OF ADVISORS**



Gene Krupa, world's  
most famous drummer

Haskell W. Harr  
Educational Director  
Slingerland Drum Company

Sonny Iggoe, famous dance  
drummer and author

C. Oscar Stover,  
Percussionist,  
Director of Bands  
Northwestern State  
College

Myron Collins, Author  
Band Director,  
Percussion Instructor

Sam Ulano  
Famous Author,  
Instructor and Drummer

# FIVE basic reasons why *Slingerland* excels



## 1 THE HOOP

The Rim-Shot\* counter hoop is the strongest made, guarantying perfect tension and sound. It is forged from solid brass to perfect size. It has more support for the flesh hoop (A) and is perfectly flat at (B) so that the flesh hoop cannot slide between the hoop and shell.

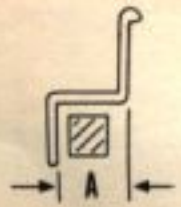

## 2 THE SHELL

The Slingerland shell is molded to a perfect circle and size in one operation. The veneers and inside solid maple reinforcing hoops are glued together at one time. This overcomes the strains on veneers which exist when a shell is made from flat plywood and then bent into a circle.

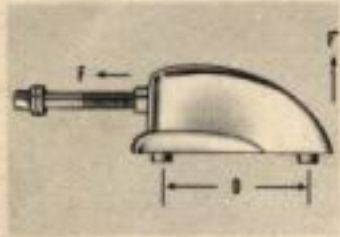
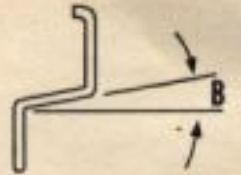

## 3 THE LUG

The Slingerland lug (or tension casing) is made of a high tensile strength non-ferrous alloy. The distance (D) is greater on Slingerland lugs. This gives more strength to resist the forces (F) and (F') when the drum is tensioned.



## 4 THE STRAINER

The new Zoomatic snare strainer is now standard on all Slingerland higher priced snare drums and parade drums. It is by far the strongest, smoothest and most efficient strainer ever designed.

## 5 THE MODERN PLANT AND EQUIPMENT



RECEPTION ROOM



SECTION OF WOOD SHOP

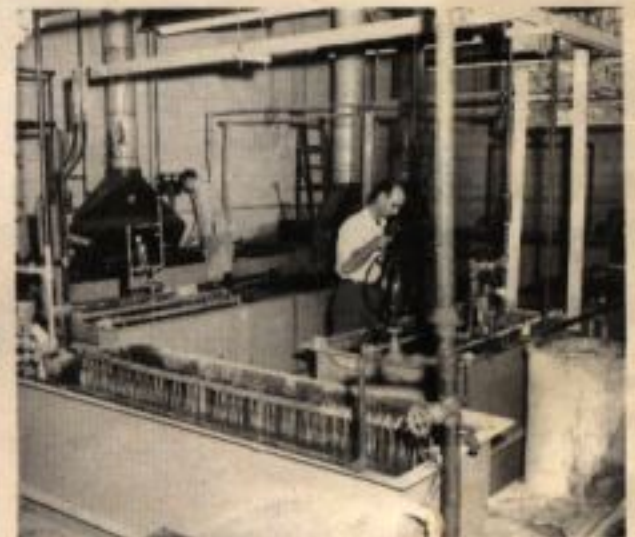

MODERN PLATING ROOM



ASSEMBLY OF TYMPANI AND ACCESSORIES



FINAL ASSEMBLY OF DRUMS



SHIPPING AND FINAL INSPECTION

# The nation's finest Drummers use Slingerland!

RUFUS JONES



BOBBY MORRIS

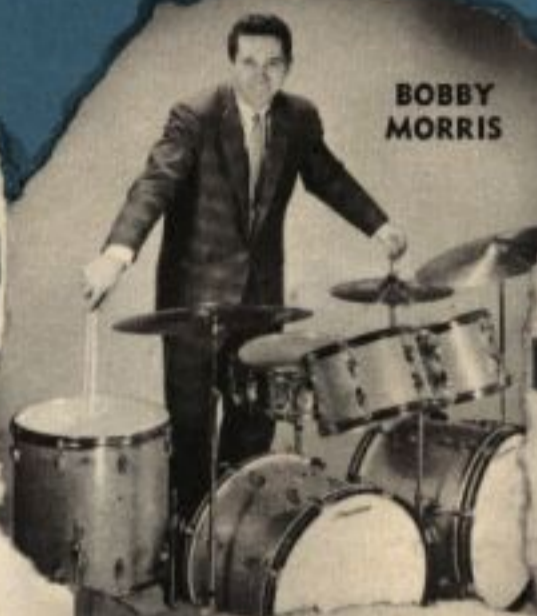

TITO PUENTE



JAKE HANNA



TONY DE NICOLA



DAVE BAILEY



GENE KRUPA



JOHN RAE



JIMMY CAMPBELL



ROY HAYNES



DANNY RICHMOND



DON OSBORNE



JOE RAICHE



FRANKIE DUNLOP



SONNY IGOE



ED SHAUGHNESSY



JAKE JERGER



RON JEFFERSON



TED SOMMER





ILLUSTRATED FINISH—MARINE PEARL

## GENE KRUPA DELUXE OUTFIT NO. 1N

WITH TRIPLE CHROME PLATING ON DRUMS AND ACCESSORIES

This outfit has been designed to meet Gene Krupa's own specifications. The newest concept, and most modern Hi-Hat stand has been included with its equal, the greatest bass drum pedal ever manufactured. Note, too, the ZooMatic snare strainer with an on-and-off ease that will amaze you. Everything is here in one outfit, making this the most outstanding outfit your dollar can buy today. Tone controls, rim-shot counter hoops, telescopic spurs, flush base stands and a muffer strap in the base drum are all included.

### SPECIAL PRICES—COMPLETE OUTFIT No. 1N

Specify Choice of Finish

Choice of Pearl Finishes . . . . . **\$460.00**  
 Choice of Lacquer Finishes . . . . . **407.00**

(IF ORDERED WITH 14x20 BASS DRUM, DEDUCT \$6.00)  
 (IF ORDERED WITH NO. 940 SNAP-ON PEDAL, ADD \$10.00)

NO. 130 5x14 CHROME SHELL SNARE DRUM  
 MAY BE SUBSTITUTED AT NO EXTRA CHARGE

Chrome

**\$460.00**

**407.00**

**16460.00**

**60.00**

**50.00**

**65.00**

**\$636.00**

Excise Tax Extra

Cymbals not included, see page 28

(1) 20" medium Ride \$60.00  
 (1) 18" medium Crash-Ride \$50.00

|           | <i>Outfit Includes</i>                                                          | <i>Chrome</i>   |
|-----------|---------------------------------------------------------------------------------|-----------------|
| No. 335   | 14 x 22 Bass Drum . . . . .                                                     | <b>\$132.00</b> |
| No. 153   | 5 1/2 x 14 Super Krupa Snare Drum                                               | <b>90.00</b>    |
| No. 1401  | 9 x 13 Tom Tom . . . . .                                                        | <b>69.00</b>    |
| No. 1405  | 16 x 16 Tom Tom . . . . .                                                       | <b>88.00</b>    |
| No. 172   | Consolette Holder attached to<br>Tom Tom and Bass Drum,<br>Chrome . . . . .     | <b>14.00</b>    |
| No. 1290  | Tom Tom Legs, Chrome . . . . .                                                  | <b>9.00</b>     |
| No. 599   | Complete, Shell Mount, Tilt<br>Cymbal Holder on right side,<br>Chrome . . . . . | <b>7.50</b>     |
| No. 33F   | Flush Base Cymbal Stand, Chrome                                                 | <b>11.50</b>    |
| No. 804   | Flush Base Hi-Hat, Chrome . . . . .                                             | <b>22.00</b>    |
| No. 802   | Flush Base Snare Stand, Chrome . . . . .                                        | <b>12.80</b>    |
| No. 938   | Pedal . . . . .                                                                 | <b>22.00</b>    |
| No. 727   | Telescopic Spurs, Chrome . . . . .                                              | <b>6.50</b>     |
| No. 1355  | Cow Bell Holder . . . . .                                                       | <b>3.00</b>     |
| No. 1377  | 4 1/2" Cow Bell . . . . .                                                       | <b>2.00</b>     |
| No. 728GK | Krupa Brushes . . . . .                                                         | <b>1.75</b>     |
| ONE PAIR  | Krupa Sticks . . . . .                                                          | <b>1.20</b>     |
|           | Muffer Strap in Bass Drum . . . . .                                             | <b>3.00</b>     |
|           | Total Value in Choice of Pearl<br>Finishes and Chrome . . . . .                 | <b>\$495.25</b> |

(2) 14" Hi HAT medium \$66.00



ILLUSTRATED FINISH—SPARKLING RED

## THE MODERN SOLO OUTFIT NO. 2R

The Modern Solo Outfit is designed for drummers who want additional tones in their solos. The unique holder (No. 171) adjusts up to sixteen inches in height, holds the toms rigid and also has a non-slipping, tilting mechanism. Tom toms and holder are easily removable for quick set-up and packing. This outfit is becoming increasingly popular.

### SPECIAL PRICES—COMPLETE OUTFIT NO. 2R

*Specify Choice of Finish*

|                                                                                                                           |                                  |
|---------------------------------------------------------------------------------------------------------------------------|----------------------------------|
| Choice of Pearl Finishes . . . . .                                                                                        | <i>Chrome</i><br><b>\$520.00</b> |
| Choice of Lacquer Finishes . . . . .                                                                                      | <b>445.00</b>                    |
| <small>(IF ORDERED WITH A 14 x 22 BASS DRUM, ADD \$6.00)<br/>(IF ORDERED WITH NO. 940 SNAP-ON PEDAL, ADD \$10.00)</small> |                                  |

*Cymbals not included, see page 28*

*Excise Tax Extra*

|           | <i>Outfit Includes</i>                                     | <i>Choice of Pearl Chrome</i> |
|-----------|------------------------------------------------------------|-------------------------------|
| No. 130   | 5" x 14" Chrome Snare Drum . . . . .                       | <b>\$ 95.00</b>               |
| No. 1411  | (Two) 8" x 12" Tom Toms . . . . .                          | <b>134.00</b>                 |
| No. 323   | 14" x 20" Bass Drum . . . . .                              | <b>124.00</b>                 |
| No. 1405  | 16" x 16" Tom Tom . . . . .                                | <b>88.00</b>                  |
| No. 171   | Telescopic Tilting Double Tom Tom Holder, Chrome . . . . . | <b>16.00</b>                  |
| No. 727   | Telescopic Spurs, Chrome . . . . .                         | <b>6.50</b>                   |
| No. 1290  | Push Button Tom Legs, Chrome . . . . .                     | <b>9.00</b>                   |
| No. 938   | Tempo King Pedal . . . . .                                 | <b>22.00</b>                  |
| No. 804   | Flush Base, Direct Pull Hi Hat, Chrome . . . . .           | <b>22.00</b>                  |
| No. 33F   | (Two) Flush Base Cymbal Stands . . . . .                   | <b>23.00</b>                  |
|           | Felt Strap in Bass Drum . . . . .                          | <b>3.00</b>                   |
| No. 802   | Flush Base Snare Stand . . . . .                           | <b>12.80</b>                  |
| No. 728GK | Krupa Brushes, Pair . . . . .                              | <b>1.75</b>                   |
| ONE PAIR  | Krupa Sticks . . . . .                                     | <b>1.20</b>                   |
|           | Total Value in Pearl Finishes . . . . .                    | <b>\$558.25</b>               |



ILLUSTRATED FINISH—LIGHT BLUE PEARL

## THE "DUET" OUTFIT NO. 14N

The two bass drums and unique method for mounting two 8" x 12" Tom Toms puts the "DUET" Outfit in a class by itself. In an amazingly short period of time this innovation is fast becoming universal to the particular solo drummer.

The adjustable, tilting Tom Tom stand and push-button legs makes disassembling the "DUET" quick and easy.

### SPECIAL PRICE—COMPLETE OUTFIT No. 14N

Specify Choice of Finish

Choice of Pearl Finishes . . . . . **\$663.00**  
 Choice of Lacquer Finishes . . . . . **566.00**

NO. 130 5x14 CHROME SHELL SNARE DRUM  
 MAY BE SUBSTITUTED AT NO EXTRA CHARGE  
 (IF ORDERED WITH NO. 940 SNAP-ON PEDALS, ADD \$20.00)

Cymbals not included, see page 28

Excise Tax Extra

### Outfit Includes

Choice of  
 Pearl &  
 Chrome

|                 |                                                              |                 |
|-----------------|--------------------------------------------------------------|-----------------|
| 2—No. 323       | 14" x 20" Sep. Tens. Bass Drums @ \$124.00 . . . . .         | <b>\$248.00</b> |
| 1—No. 153       | 5½" x 14" Artist Model Snare Drum . . . . .                  | <b>90.00</b>    |
| 2—No. 1411      | 8" x 12" Sep. Tens. Tom Toms @ \$68.00 . . . . .             | <b>136.00</b>   |
| 1—No. 1405      | 16" x 16" Sep. Tens. Tom Tom                                 | <b>88.00</b>    |
| 1 set No. 1290  | Push Button Legs . . . . .                                   | <b>9.00</b>     |
| 2 pr. No. 727   | Telescopic Spurs @ \$6.50 . . . . .                          | <b>13.00</b>    |
| 2—No. 33F       | Flush-Base Cymbal Stands @ \$11.50 . . . . .                 | <b>23.00</b>    |
| 1—No. 802       | Flush-Base Snare Drum Stand                                  | <b>12.80</b>    |
| 1—No. 804       | Hi Hat with Direct Pull . . . . .                            | <b>22.00</b>    |
| 2—No. 938       | Pedals @ \$22.00 . . . . .                                   | <b>44.00</b>    |
| 1—No. 176       | Floor Stand for Two Tom Toms . . . . .                       | <b>14.00</b>    |
| 1 pr.           | Krupa Sticks . . . . .                                       | <b>1.20</b>     |
| 1 pr. No. 728GK | Brushes . . . . .                                            | <b>1.75</b>     |
|                 | Muffler Straps in Bass Drums                                 | <b>6.00</b>     |
|                 | Total Value in Choice of Pearl Finishes and Chrome . . . . . | <b>\$708.75</b> |





ILLUSTRATED FINISH—SPARKLING SILVER

## MODERN JAZZ OUTFIT NO. 9N

The name "Modern Jazz Outfit" speaks for itself. The new chrome "Sound King" snare drum with the new Zoomatic Strainer, combined with 20" bass, 8" x 12" and 14" x 14" toms that produce that important big sound, yet are easy to pack and carry.

### SPECIAL PRICE—COMPLETE OUTFIT No. 9N

*Specify Choice of Finish*

|                                                                     |               |                 |
|---------------------------------------------------------------------|---------------|-----------------|
| Choice of Pearl Finishes . . . . .                                  | <i>Chrome</i> | <b>\$440.00</b> |
| Choice of Lacquer Finishes . . . . .                                |               | <b>380.00</b>   |
| <small>(IF ORDERED WITH NO. 940 SNAP-ON PEDAL, ADD \$10.00)</small> |               |                 |

|                        |                                                              | <i>Choice of Pearl Chrome</i> |
|------------------------|--------------------------------------------------------------|-------------------------------|
| <i>Outfit Includes</i> |                                                              |                               |
| No. 323                | 14" x 20" Bass Drum . . . . .                                | <b>\$124.00</b>               |
| No. 130                | 5" x 14" Chrome Snare Drum . . . . .                         | <b>95.00</b>                  |
| No. 1411               | 8" x 12" Tom Tom . . . . .                                   | <b>67.00</b>                  |
| No. 1403               | 14" x 14" Tom Tom . . . . .                                  | <b>83.00</b>                  |
| No. 172                | Console holder attached to Tom and Bass . . . . .            | <b>14.00</b>                  |
| No. 1290               | Tom Tom Legs, Chrome . . . . .                               | <b>9.00</b>                   |
| No. 33F                | Flush Base Cymbal Stand, Chrome . . . . .                    | <b>11.50</b>                  |
| No. 804                | Flush Base Hi-Hat, Chrome . . . . .                          | <b>22.00</b>                  |
| No. 802                | Flush Base Snare Stand, Chrome . . . . .                     | <b>12.80</b>                  |
| No. 938                | Pedal . . . . .                                              | <b>22.00</b>                  |
| No. 727                | Telescopic Spurs, Chrome . . . . .                           | <b>6.50</b>                   |
| No. 1355               | 2¼" Gow Bell Holder, Chrome . . . . .                        | <b>3.00</b>                   |
| No. 1377               | 4½" Cowbell . . . . .                                        | <b>2.00</b>                   |
| No. 728GK              | Krupa Brushes, Pair . . . . .                                | <b>1.75</b>                   |
| No. 5A                 | Krupa Sticks, Pair . . . . .                                 | <b>1.20</b>                   |
|                        | Muffler Strap in Bass Drum . . . . .                         | <b>3.00</b>                   |
|                        | Total Value in Choice of Pearl Finishes and Chrome . . . . . | <b>\$477.75</b>               |

*Cymbals not included, see page 28*

*Excise Tax Extra*

*Slingerland* **THE FOREMOST IN DRUMS**



ILLUSTRATED IN SPARKLING PINK CHAMPAGNE

## "Jet" OUTFIT NO. 20N

WITH CHROME HOOPS ON BASS DRUM AND SNAP ON PEDAL

The new Jet Outfit originated in California and is becoming very popular. The chrome hoops on the base drum look great. The new snap on pedal snaps in place in a second and will not come loose from the Bass Drum. Note the floor stand for the 8" x 12" Tom Tom.

### SPECIAL PRICES — COMPLETE OUTFIT NO. 20N

*Specify Choice of Finish*

|                                 |               |
|---------------------------------|---------------|
|                                 | <i>Chrome</i> |
| Choice of Pearl Finishes.....   | \$464.00      |
| Choice of Lacquer Finishes..... | 422.00        |

(IF ORDERED WITH No. 172L CONSOLETTA TOM HOLDER IN PLACE OF No. 805 STAND, DEDUCT \$5.50)

*Cymbals not included, see page 28*

*Excise Tax Extra*

SNAP ON  
PEDAL



*Choice of  
Pearl  
Chrome*

|           | <i>Outfit Includes</i>                                  |                 |
|-----------|---------------------------------------------------------|-----------------|
| No. 312M  | 14"x18" Sep. tens. Bass Drum with Chrome Hoops .....    | \$119.00        |
| No. 130   | 5"x14" Chrome Sound King Snare Drum .....               | 95.00           |
| No. 1411  | 8"x12" Sep. tens. tom tom.....                          | 67.00           |
| No. 1403  | 14"x14" Sep. tens. tom tom with legs.                   | 92.00           |
| No. 727   | Telescopic, shell mount spurs.....                      | 6.50            |
| No. 802   | Flush base stands for snare drum and tom tom .....      | 25.60           |
| No. 805   | Flush bass stand for tom tom.....                       | 19.50           |
| No. 804   | Flush base Hi-Hat, chrome.....                          | 22.00           |
| No. 33F   | Flush base Cymbal stand, chrome..                       | 11.50           |
| No. 940   | Snap on tempo king pedal.....                           | 30.00           |
| No. 728GK | Krupa Brushes, pair.....                                | 1.75            |
| No. GKN   | Nylon tips Krupa sticks, pair.....                      | 1.95            |
|           | Muffler strap in Bass Drum.....                         | 3.00            |
|           | Total value in Choice of Pearl finishes and Chrome..... | <u>\$494.80</u> |

# WINDSOR

## OUTFIT NO. 6N

A top professional outfit featuring the new Zoomatic Snare Strainer. An excellent outfit for drummers playing with a small band. Floor tom toms may be added later, if desired.

|           | <i>Outfit Includes</i>                                                | <i>Choice of Pearl Chrome</i> |
|-----------|-----------------------------------------------------------------------|-------------------------------|
| No. 335   | 14" x 22" Bass Drum.....                                              | \$132.00                      |
| No. 153   | 5½" x 14" Snare Drum.....                                             | 90.00                         |
| No. 1401  | 9" x 13" Tom Tom.....                                                 | 69.00                         |
| No. 172   | Consolette Holder attached to Tom Tom and Bass Drum.....              | 14.00                         |
| No. 599   | Complete, Shell Mount, Tilt Cymbal Holder, on Right Side, Chrome..... | 7.50                          |
| No. 33F   | Flush Base Cymbal Stand, Chrome.....                                  | 11.50                         |
| No. 803   | Flush Base Hi-Hat, Chrome.....                                        | 19.80                         |
| No. 802   | Flush Base Snare Stand, Chrome.....                                   | 12.80                         |
| No. AA    | Pedal.....                                                            | 20.00                         |
| No. 727   | Telescopic Spurs, Chrome.....                                         | 6.50                          |
| No. 1377  | 4½" Cow Bell.....                                                     | 2.00                          |
| No. 1355  | Cow Bell Holder, Chrome.....                                          | 3.00                          |
| No. 728GK | Krupa Brushes.....                                                    | 1.75                          |
| No. 5A    | Krupa Sticks.....                                                     | 1.20                          |
|           | Muffler Strap in Bass Drum.....                                       | 3.00                          |
|           | Total Value in Choice of Pearl Finishes.....                          | \$394.05                      |



ILLUSTRATED IN SPARKLING GOLD PEARL

### SPECIAL PRICES—COMPLETE OUTFIT No. 6N

|                                 |                        |
|---------------------------------|------------------------|
| Choice of Pearl Finishes.....   | <i>Chrome</i> \$365.00 |
| Choice of Lacquer Finishes..... | \$325.00               |

(If ordered with a 14 x 20 Bass Drum deduct \$6.00)

NO. 130 5 X 14 CHROME SHELL SNARE DRUM MAY BE SUBSTITUTED AT NO EXTRA CHARGE

*Excise Tax Extra*

*Cymbals not included, see page 28*



ILLUSTRATED IN CAPRI PEARL

### SPECIAL PRICES—COMPLETE OUTFIT NO. 3N

|                                 |                        |
|---------------------------------|------------------------|
| Choice of Pearl Finishes.....   | <i>Chrome</i> \$262.00 |
| Choice of Lacquer Finishes..... | \$224.00               |
| New Knotty Pine Finish.....     | \$226.00               |

(If ordered with a 14 x 20 Bass Drum deduct \$6.00)

NO. 130 5 X 14 CHROME SHELL SNARE DRUM MAY BE SUBSTITUTED AT NO EXTRA CHARGE

*Cymbals not included, see page 28 Excise Tax Extra*

## Jam Session

### OUTFIT NO. 3N

Ideal for the drummer who wants the best equipment, but has a limited budget. The new Zoomatic Snare Strainer is featured. Additional tom toms may be added later.

|           | <i>Outfit Includes</i>                        | <i>Chrome</i> |
|-----------|-----------------------------------------------|---------------|
| No. 335   | 14" x 22" Bass Drum.....                      | \$132.00      |
| No. 153   | 5½" x 14" Snare Drum.....                     | 90.00         |
| No. 803   | Flush Base Hi-Hat, Chrome.....                | 19.80         |
| No. 802   | Flush Base Snare Stand, Chrome.....           | 12.80         |
| No. 939   | Epic Pedal.....                               | 16.00         |
| No. 727   | Telescopic Spurs, Chrome.....                 | 6.50          |
| No. 599   | Attached Cymbal Holder (Tilting), Chrome..... | 7.50          |
| No. 1355  | Cow Bell Holder, Chrome.....                  | 3.00          |
| No. 1377  | 4½" Cow Bell.....                             | 1.75          |
| ONE PAIR  | Krupa Sticks.....                             | 1.20          |
| No. 728GK | Krupa Brushes.....                            | 1.75          |
|           | Muffler Strap in Bass Drum.....               | 3.00          |
|           | Total Value in Choice of Pearl Finishes.....  | \$295.30      |



ILLUSTRATED IN BLUE RIPPLE PEARL

**SPECIAL PRICES—COMPLETE OUTFIT NO. 75N**

|                                                     |                         |                 |
|-----------------------------------------------------|-------------------------|-----------------|
| Choice of Pearl Finishes.....                       | <i>Chrome</i>           | <b>\$465.00</b> |
| Choice of Lacquer Finishes.....                     |                         | <b>400.00</b>   |
| (IF ORDERED WITH A 14" x 20" BASS DRUM, ADD \$5.00) |                         |                 |
| Cymbals not included, see page 28                   |                         |                 |
|                                                     | <i>Excise tax extra</i> |                 |

**MODERN COMBO**

**OUTFIT NO. 75N**



A new five piece outfit with single head tomtoms that telescope inside each other for easy carrying and compact storage. Perfect for the jobbing drummer.

*Outfit Includes*

|                                 |                                                  |               |                 |
|---------------------------------|--------------------------------------------------|---------------|-----------------|
| No. 312                         | 14" x 18" Sep. Tens. Bass Drum                   | <i>Chrome</i> | <b>\$119.00</b> |
| No. 130                         | 5" x 14" Chrome Snare Drum                       |               | <b>95.00</b>    |
| No. 1430                        | 9" x 10" Single Head Tom.                        |               | <b>50.00</b>    |
| No. 1431                        | 9" x 13" Single Head Tom.                        |               | <b>56.00</b>    |
| No. 1432                        | 14" x 16" Single Head Tom                        |               | <b>83.00</b>    |
| No. 171                         | Telescopic Tilting Double Tom Tom Holder, Chrome |               | <b>16.00</b>    |
| No. 1290                        | Tom Tom Legs, Chrome...                          |               | <b>9.00</b>     |
| No. 804                         | Flush Base, Direct Pull Hi Hat                   |               | <b>22.00</b>    |
| No. 938                         | Tempo King Pedal                                 |               | <b>22.00</b>    |
| No. 802                         | Flush Base Snare Stand                           |               | <b>12.80</b>    |
| No. 727                         | Telescopic Spurs                                 |               | <b>6.50</b>     |
| No. 33F                         | Flush Base Cymbal Stand.                         |               | <b>11.50</b>    |
| No. 1358                        | Shell Mount Cow Bell Holder                      |               | <b>5.50</b>     |
| No. 1377                        | 4 1/2" Cow Bell                                  |               | <b>2.00</b>     |
| No. 1201                        | Jerger Instruction Book..                        |               | <b>2.00</b>     |
| No. 728GK                       | Brushes, Pair                                    |               | <b>1.75</b>     |
| No. GKN                         | Krupa Nylon Tip Stick, Pr.                       |               | <b>1.95</b>     |
| Total Value in Pearl and Chrome |                                                  |               | <b>\$516.00</b> |

**Swingster**

**OUTFIT NO. 8N**

Excellent for the beginner, as it provides the basic necessary equipment all in the proper sizes and to professional drum standards, to which the extra tom toms, sock pedals and other equipment can be added. Metal parts are hand plated and highly polished with hand rubbed lacquer shell and wood parts. Here's high quality at a nominal cost. Excellent for teacher studio and promotion of student use.

|            |                                 |                 |
|------------|---------------------------------|-----------------|
|            | <i>Outfit Includes</i>          | <i>Chrome</i>   |
| No. 334    | 14" x 22" Sing. Tens. Bass Drum | <b>\$ 89.00</b> |
| No. 151    | 5 1/4" x 14" Student Snare Drum | <b>54.00</b>    |
| No. 1800   | 10" Tuscanese Cymbal....        | <b>5.80</b>     |
| No. 590-14 | Shell Mount Cymbal Holder       | <b>5.90</b>     |
| No. 1355   | Cowbell Holder, Chrome..        | <b>3.00</b>     |
| No. 1376   | 3 1/4" Cow Bell                 | <b>1.75</b>     |
| No. 801    | Snare Drum Stand, Chrome        | <b>9.50</b>     |
| No. 939    | Epic Pedal                      | <b>16.00</b>    |
| No. 728L   | Brushes, Pair                   | <b>1.55</b>     |
| No. 1279   | Chrome Spurs, Pair              | <b>3.00</b>     |
| No. 1201   | Jerger Instruction Book..       | <b>2.00</b>     |
| ONE PAIR   | Krupa Sticks                    | <b>1.20</b>     |
|            | Muffler Strap in Bass Drum      | <b>3.00</b>     |
|            | Total Value in Lacquer Finishes | <b>\$195.70</b> |



ILLUSTRATED IN BLACK & SILVER LACQUER

**SPECIAL PRICES—COMPLETE OUTFIT No. 8N**

|                                                       |               |                 |
|-------------------------------------------------------|---------------|-----------------|
| Choice of Lacquer Finishes.....                       | <i>Chrome</i> | <b>\$184.00</b> |
| Choice of Pearl Finishes.....                         |               | <b>218.00</b>   |
| (If ordered with a 14" x 20" Bass Drum deduct \$6.00) |               |                 |
| <i>Excise Tax Extra</i>                               |               |                 |

# STAGE BAND

## OUTFIT NO. 74N

A modern four-piece outfit for the rising young drummer. Flush bass snare stand, attached cymbal holder, telescopic spurs and push button tom legs make this outfit extremely simple to set up. All drums have separate tension, center lug, with Rim-Shot hoops. Tone controls are standard in snare drum and tom toms.

| <i>Outfit Includes</i> |                                        | <i>Chrome</i> |
|------------------------|----------------------------------------|---------------|
| No. 327                | 14" x 22" Sep. Tens. Bass Drum         | \$ 92.00      |
| No. 162                | 5½" x 14" Sep. Tens. Snare Drum        | 54.00         |
| No. 1417               | 9" x 13" Sep. Tens. Tom Tom            | 52.00         |
| No. 1418               | 12" x 15" Sep. Tens. Tom Tom with Legs | 63.00         |
| No. 1286               | Tom Tom Holder, Chrome                 | 6.00          |
| No. 727                | Telescopic Spurs, Chrome               | 6.50          |
| No. 590-14             | Shell Mount Cymbal Holder              | 5.90          |
| No. 1355               | Cowbell Holder, Chrome                 | 3.00          |
| No. 1376               | 3½" Cow Bell                           | 1.75          |
| No. 802                | Chrome Snare Drum Stand                | 12.80         |
| No. 939                | Epic Pedal                             | 16.00         |
| No. 728GK              | Brushes, Pair                          | 1.75          |
| ONE PAIR               | Krupa Sticks                           | 1.20          |
|                        | Muffler Strap in Bass Drum             | 3.00          |
|                        | Total Value in Lacquer Finishes        | \$318.90      |



ILLUSTRATED IN BLUE AND SILVER LACQUER

### SPECIAL PRICES—COMPLETE OUTFIT NO. 74N

|                                          |               |                         |
|------------------------------------------|---------------|-------------------------|
| Choice of Lacquer Finishes               | <i>Chrome</i> | \$300.00                |
| Choice of Pearl Finishes                 |               | 358.00                  |
| <i>Cymbals not included, see page 28</i> |               | <i>Excise Tax Extra</i> |



ILLUSTRATED IN MAROON AND GOLD LACQUER

### SPECIAL PRICES—COMPLETE OUTFIT NO. 73N

|                                          |               |                         |
|------------------------------------------|---------------|-------------------------|
| Choice of Lacquer Finishes               | <i>Chrome</i> | \$240.00                |
| Choice of Pearl Finishes                 |               | 282.00                  |
| <i>Cymbals not included, see page 28</i> |               | <i>Excise Tax Extra</i> |

## Jam Session

### OUTFIT NO. 73N

An excellent outfit for drummers with a limited budget. All drums have separate tension with Rim-Shot hoops and tone control on snare drum and tom tom. Flush base snare stand, attached cymbal holder and telescopic spurs are standard.

| <i>Outfit Includes</i> |                                 | <i>Chrome</i> |
|------------------------|---------------------------------|---------------|
| No. 326                | 14" x 20" Sep. Tens. Bass Drum  | \$ 90.00      |
| No. 162                | 5½" x 14" Sep. Tens. Snare Drum | 54.00         |
| No. 1416               | 8" x 12" Sep. Tens. Tom Tom     | 50.00         |
| No. 1286               | Tom Tom Holder, Chrome          | 6.00          |
| No. 727                | Telescopic Spurs, Chrome        | 6.50          |
| No. 590-14             | Shell Mount Cymbal Holder       | 5.90          |
| No. 1355               | Cowbell Holder, Chrome          | 3.00          |
| No. 1376               | 3½" Cow Bell                    | 1.75          |
| No. 802                | Chrome Snare Drum Stand         | 12.80         |
| No. 939                | Epic Pedal                      | 16.00         |
| No. 728GK              | Brushes, Pair                   | 1.75          |
| ONE PAIR               | Krupa Sticks                    | 1.20          |
|                        | Muffler Strap in Bass Drum      | 3.00          |
|                        | Total Value in Lacquer Finishes | \$251.90      |



ILLUSTRATED FINISH—MAHOGANY

# Swing Master

## OUTFIT NO. 63N

A very popular outfit with all separate tension drums, flush base snare stand, attached cymbal holder, Rim-Shot hoops, tone control on tom and snare drum, and telescopic spurs. Ideal for the advanced student or young professional drummer.

*Outfit Includes*

|            |                                 | <i>Chrome</i>   |
|------------|---------------------------------|-----------------|
| No. 336    | 14" x 22" Sep. Tens. Bass Drum  | <b>\$102.00</b> |
| No. 162    | 5½" x 14" Sep. Tens. Snare Drum | <b>54.00</b>    |
| No. 1415   | 8" x 12" Sep. Tens. Tom         | <b>60.00</b>    |
| No. 1286   | Tom Tom Holder, Chrome          | <b>6.00</b>     |
| No. 727    | Telescopic Spurs, Chrome        | <b>6.50</b>     |
| No. 590-14 | Shell Mount Cymbal Holder       | <b>5.90</b>     |
| No. 1355   | Cowbell Holder, Chrome          | <b>3.00</b>     |
| No. 1376   | 3½" Cowbell                     | <b>1.75</b>     |
| No. 802    | Snare Drum Stand, Chrome        | <b>12.80</b>    |
| No. 939    | Epic Pedal                      | <b>16.00</b>    |
| No. 728GK  | Brushes, Pair                   | <b>1.75</b>     |
| ONE PAIR   | Krupa Sticks                    | <b>1.20</b>     |
|            | Muffler Strap in Bass Drum      | <b>3.00</b>     |
|            | Total Value in Lacquer Finishes | <b>\$273.90</b> |

**SPECIAL PRICES—COMPLETE OUTFIT No. 63N**

|                                                                     |                                  |
|---------------------------------------------------------------------|----------------------------------|
| Choice of Lacquer Finishes                                          | <i>Chrome</i><br><b>\$254.00</b> |
| Choice of Pearl Finishes                                            | <b>297.00</b>                    |
| <small>(If ordered with a 14"x20" bass drum, deduct \$6.00)</small> |                                  |
| Cymbals not included, see page 28                                   | <i>Excise Tax Extra</i>          |

# BE BOP

## OUTFIT NO. 62N

An all-professional outfit for students and amateur drummers. Both drums are separate tension. Bass drum has telescopic spurs and attached cymbal holder. Snare drum has Rim-Shot hoops and tone control. An excellent beginning or advanced outfit.

*Outfit Includes*

|            |                                 | <i>Chrome</i>   |
|------------|---------------------------------|-----------------|
| No. 336    | 14" x 22" Sep. Tens. Bass Drum  | <b>\$102.00</b> |
| No. 162    | 5½" x 14" Sep. Tens. Snare Drum | <b>54.00</b>    |
| No. 727    | Telescopic Spurs, Chrome        | <b>6.50</b>     |
| No. 590-14 | Shell Mount Cymbal Holder       | <b>5.90</b>     |
| No. 1355   | Cowbell Holder, Chrome          | <b>3.00</b>     |
| No. 1376   | 3½" Cowbell                     | <b>1.75</b>     |
| No. 802    | Snare Drum Stand, Chrome        | <b>12.80</b>    |
| No. 939    | Epic Pedal                      | <b>16.00</b>    |
| No. 728GK  | Brushes, Pair                   | <b>1.75</b>     |
| ONE PAIR   | Krupa Sticks                    | <b>1.20</b>     |
|            | Muffler Strap in Bass Drum      | <b>3.00</b>     |
|            | Total Value in Lacquer Finishes | <b>\$207.90</b> |



ILLUSTRATED FINISH—GREEN AND GOLD LACQUER

**SPECIAL PRICES—COMPLETE OUTFIT No. 62N**

|                                                                     |                                  |
|---------------------------------------------------------------------|----------------------------------|
| Choice of Lacquer Finishes                                          | <i>Chrome</i><br><b>\$196.00</b> |
| Choice of Pearl Finishes                                            | <b>231.00</b>                    |
| <small>(If ordered with a 14"x20" bass drum, deduct \$6.00)</small> |                                  |
| Cymbals not included, see page 28                                   | <i>Excise Tax Extra</i>          |

# Slingerland

## COCKTAIL OUTFIT

The stand-up performer has been waiting a long time for this newest concept in cocktail units. It is composed of many features, which up to now only the more expensive, larger ensembles had. Note the disappearing spurs, the modern large chrome handle for easy pickup and go, the built-in snare stand that adjusts the snare drum from 27" to 38" from the floor. This outfit is compact enough to fit in the smallest playing area, yet with the real bass and snare sound comparable to no other cocktail outfit.

### SPECIAL PRICE

**No. 286** Choice of Pearl Finishes.....\$190.00  
*Excise Tax Extra*

|                            |                                 |                               |
|----------------------------|---------------------------------|-------------------------------|
| <i>Outfit consists of:</i> |                                 | <i>Choice of Pearl Chrome</i> |
| <b>No. 161</b>             | 5½" x 14" Snare Drum.....       | \$ 64.00                      |
| <b>No. 1405WF</b>          | 16" x 16" Bass Drum.....        | 88.00                         |
| <b>No. 173</b>             | Telescopic Snare Stand.....     | 14.00                         |
| <b>No. 174</b>             | Handle.....                     | 3.50                          |
| <b>No. 727</b>             | Telescopic Spurs.....           | 6.50                          |
| <b>No. 939</b>             | Bass Drum Pedal.....            | 16.00                         |
| <b>No. 7704</b>            | Cow Bell Holder.....            | 4.00                          |
| <b>No. 1376</b>            | 3½" Cow Bell.....               | 1.75                          |
| <b>No. 728GK</b>           | Brushes, Pair.....              | 1.75                          |
| <b>One Pair</b>            | Krupa Sticks.....               | 1.20                          |
|                            | Muffler Strap in Bass Drum..... | 2.50                          |
|                            | <b>TOTAL VALUE.....</b>         | <b>\$203.20</b>               |



No. 286

## COCKTAIL DRUMS

### SINGLE HEAD COCKTAIL DRUM

WITH TONE CONTROL AND ADJUSTABLE SNARE STRAINER

A special floor model drum for combo use that is adjustable for height up to 38" from floor. Shell is 14" in diameter, and 23½" deep. Note the exceptionally strong tubular steel legs for solidity in set-up. Ideal for small combo use, for singers and extra men.

*Chrome*

**No. 288** Choice of Pearl, Legs included \$ 90.00

**No. 287** Choice of Lacquer, Legs included 74.00

*Excise Tax Extra*

### NEW TWO HEADED COCKTAIL DRUM

WITH TONE CONTROL AND ADJUSTABLE SNARE STRAINER

A deluxe cocktail drum. The two heads give more carrying power and the bottom head can be used to keep the tempo with our reversible pedal. The shell is 14" x 23½" and is adjustable in height up to 38" from the floor.

*Chrome*

**No. 291** Choice of Pearl, Legs included \$115.00

**No. 292** Choice of Lacquer, Legs included 99.00

*Excise Tax Extra*

### EXTRA ACCESSORIES

|                 |                                     |       |
|-----------------|-------------------------------------|-------|
| <b>No. 944</b>  | Reversible Pedal.....               | 19.50 |
| <b>No. 945</b>  | Cross Bar, chrome.....              | 5.00  |
| <b>*No. 289</b> | Case (fits either cocktail drum)    | 22.00 |
| <b>No. 598</b>  | Cymbal Arm and Bracket....          | 6.00  |
| <b>No. 1360</b> | Cow Bell and Wood Block Holder..... | 10.00 |



No. 288



No. 291

*Gene Krupa*

**SOUND KING  
CHROME  
SNARE DRUM**



**WITH THE NEW ZOOMATIC SNARE STRAINER**

This new Gene Krupa Snare Drum with the new Zoomatic Strainer fulfills the ultimate desire of distinguished drummers. Its extra sturdy solid brass shell, triple chrome plated, needs no sound disturbing center bead. Supplied with tone control, Rim-Shot hoops, twenty wire snappy snares, and plastic heads.

|                                 | <i>Chrome</i> |
|---------------------------------|---------------|
| No. 130 5"x14" Eight Lugs.....  | \$ 95.00      |
| No. 131 6½"x14" Eight Lugs..... | 95.00         |
| No. 132 5"x14" Ten Lugs.....    | 100.00        |
| No. 133 6½"x14" Ten Lugs.....   | 100.00        |

*Excise Tax Extra*



*New* **RADIO KING CHROME SHELL  
SNARE DRUM**



The ever popular Radio King Snare Strainer has now been incorporated with a sturdy solid brass chromed shell with no sound distorting center bead. A real swinging drum. Tone control, twenty wire snappy snares, eight self-aligning lugs, Rim-Shot counterhoops, and plastic heads make this model a real buy.

|                                                                 | <i>Chrome</i>  |
|-----------------------------------------------------------------|----------------|
| <b>No. 134</b> 5"x14" 8-lug Radio King Chrome Snare Drum.....   | <b>\$90.00</b> |
| <b>No. 135</b> 6½"x14" 8-lug Radio King Chrome Snare Drum.....  | <b>90.00</b>   |
| <b>No. 141</b> 5"x14" 10-lug Radio King Chrome Snare Drum.....  | <b>95.00</b>   |
| <b>No. 142</b> 6½"x14" 10-lug Radio King Chrome Snare Drum..... | <b>95.00</b>   |

*Excise Tax Extra*

## FESTIVAL MODEL CHROME SNARE DRUM



An extremely popular, low-priced, chrome shell snare drum. The sturdy shell is made of solid brass with the batter and snare edges flanged in; it needs no sound disturbing center bead for extra strength. Equipped with tone control, Rapid Strainer, twenty wire snappy snares, and Rim Shot hoops. Plastic heads are standard.

*Chrome*

- No. 136 5" x 14" 8-lug Festival Model Chrome Snare Drum . . . . . **\$84.00**
- No. 137 6½" x 14" 8-lug Festival Model Chrome Snare Drum . . . . . **84.00**
- No. 138 5" x 14" 10-lug Festival Model Chrome Snare Drum . . . . . **88.00**
- No. 139 6½" x 14" 10-lug Festival Model Chrome Snare Drum . . . . . **88.00**

*(Excise Tax Extra)*

## STUDENT ALUMINUM SHELL MODEL



The shell is made of anodized aluminum with the batter and snare edges turned over for extra strength. Its sound and tone are almost as good as the sound of a chrome plated, solid brass shell. Rapid strainer, tone control, sixteen wire snappy snares, six self-aligning lugs. Rim Shot hoops, and plastic heads are standard. Ideal for students with a limited budget.

*Chrome*

- No. 140 5" x 14" Student Aluminum Shell Model . . . . . **\$65.00**

*Excise Tax Extra*

## ARTIST MODEL SNARE DRUM

**With a Solid Maple Shell**



The new Zoomatic Snare Strainer and solid maple shell places this model far above any other wood shell snare drum. Rim Shot counterhoops, tone control, twenty wire snappy snares and eight self-aligning lugs are standard. Supplied with Sound King plastic heads unless otherwise specified.

*Chrome*

- No. 153 5½" x 14" 8 Lugs, Choice of Pearl. **\$90.00**
- No. 155 7" x 14" 8 Lugs, Choice of Pearl. . . . **90.00**
- No. 156 5½" x 14" 10 Lugs, Choice of Pearl. **95.00**

*Excise Tax Extra*

## RADIO KING MODEL

A long-time favorite of our nation's top dance drummers. Featuring our world famous solid maple shell, Rim Shot counterhoops, eight separate tension lugs, tone control and twenty wire snappy snares. Sound King plastic heads are standard, unless calf is requested.

- Chrome*
- No. 143** 5½" x 14" Choice of Pearl Finish . . . **\$88.00**  
**No. 128** 5½" x 14" Choice of Lacquer Finish. **78.00**  
**No. 111** 7" x 14" Choice of Pearl Finish . . . **90.00**  
**No. 112** 7" x 14" Choice of Lacquer Finish. **80.00**

*Excise Tax Extra*



ILLUSTRATED IN MARINE PEARL

## HOLLYWOOD ACE MODEL

A very popular medium-priced snare drum, with our molded 3-ply shell and solid maple inside reinforcing hoops, Rapid strainer, tone control, Rim Shot hoops, sixteen wire snappy snares and eight separate tension lugs. Sound King plastic heads are standard, unless calf is requested.

- Chrome*
- No. 146** 5½" x 14" Choice of Pearl Finish . . . **\$77.50**  
**No. 147** 5½" x 14" Choice of Lacquer Finish. **67.50**  
**No. 148** 7" x 14" Choice of Pearl Finish . . . **77.50**  
**No. 149** 7" x 14" Choice of Lacquer Finish. **67.50**

*Excise Tax Extra*



ILLUSTRATED IN SPARKLING BLUE PEARL

## DELUXE STUDENT MODEL

This model is used by most advanced students and some professionals. It features six separate tension lugs, Rapid strainer, molded 3-ply shell, tone control, Rim Shot counterhoops and twelve wire snappy snares. Sound King plastic heads are standard unless calf is requested.

- Chrome*
- No. 161** 5½" x 14" Choice of Pearl Finish . . . **\$62.00**  
**No. 162** 5½" x 14" Choice of Lacquer Finish. **54.00**

*Excise Tax Extra*



ILLUSTRATED IN SPARKLING GOLD PEARL

## STUDENT MODEL SNARE DRUM



ILLUSTRATED FINISH—BLUE AND SILVER

The Student Model Snare is designed to give the maximum amount of performance at the lowest price. It features: Rapid snare strainer, and sixteen wire snares, molded 3-ply shell with solid maple inside reinforcing hoops, eight separate tension lugs, single flanged metal hoops. Sound King plastic heads are standard, unless calf is requested.

- |                                                                  |                |
|------------------------------------------------------------------|----------------|
|                                                                  | <i>Chrome</i>  |
| <b>No. 151</b> 5½" x 14" Choice of Lacquer or Mahogany . . . . . | <b>\$54.00</b> |
| <b>No. 152</b> 5½" x 14" Choice of Pearl Finishes . . . . .      | <b>62.00</b>   |
| <b>No. 157</b> 7" x 14" Choice of Lacquer or Mahogany . . . . .  | <b>54.00</b>   |
| <b>No. 154</b> 7" x 14" Choice of Pearl Finishes . . . . .       | <b>64.00</b>   |

*Excise Tax Extra*

## SPECIAL STUDENT MODEL

The Special Student Snare Drum is a good sounding, sturdy drum. The flat chrome hoops and six separate tension lugs are the reason it can be priced so low. It has the regular Slingerland molded 3-ply shell, Rapid snare strainer and twelve wire snares. Plastic heads supplied unless calf is requested.

- |                                                             |                |
|-------------------------------------------------------------|----------------|
|                                                             | <i>Chrome</i>  |
| <b>No. 158</b> 5½" x 14" Choice of Lacquer Colors . . . . . | <b>\$49.00</b> |
| <b>No. 159</b> 5½" x 14" Choice of Pearl Colors . . . . .   | <b>57.00</b>   |

*Excise Tax Extra*



ILLUSTRATED FINISH—SPARKLING SILVER PEARL

## JUNIOR SNARE DRUM



Here is economy, good appearance, and good performance in a junior snare drum. For youngsters in grade school bands or orchestra and for rhythm band performance. Shell is 4" x 13", equipped with six rods, and adjustable strainer. Plastic heads supplied unless calf is requested. It's the biggest value in a junior drum today. Please specify finish when ordering.

- |                                                                          |                |
|--------------------------------------------------------------------------|----------------|
| <b>No. 175</b> Wood shell, 4" x 13", mahogany and chrome parts . . . . . | <b>\$30.00</b> |
| Special lacquer, colors on wood shell model, add extra . . . . .         | <b>1.50</b>    |

*Excise Tax Extra*

## DELUXE CONCERT KING MODEL SNARE DRUMS

The Concert King Model Snare Drum is the ultimate in concert drums. The new Zoomatic snare strainer, our famous molded 3-ply veneer shell with solid maple inside reinforcing hoops, Rim Shot counter hoops, sixteen self-aligning lugs and tone control give it a superb tone. Sound King plastic heads are standard, unless calf is requested. Twenty wire snappy snares are standard.

|                                                        |                         |
|--------------------------------------------------------|-------------------------|
|                                                        | <i>Chrome</i>           |
| <b>No. 20A</b> 8" x 15" Choice of Mahogany or Lacquer  | \$85.00                 |
| <b>No. 20C</b> 6½" x 15" Choice of Mahogany or Lacquer | 83.00                   |
| <b>No. 20E</b> 6½" x 14" Choice of Mahogany or Lacquer | 80.00                   |
|                                                        | <i>Excise Tax Extra</i> |
| Choice of Pearl Finishes, Add                          | \$10.00                 |
| Gut Snares, Extra                                      | 2.00                    |



## STANDARD CONCERT MODEL SNARE DRUMS

The Standard Concert Model Snare Drum is accepted as an outstanding instrument in the medium priced field. Featuring the Rapid snare strainer, tone control, sixteen wire snares, molded 3-ply veneer shell with solid maple inside reinforcing hoops, sixteen self-aligning lugs and Rim Shot counterhoops. Sound King plastic heads are standard, unless calf is requested.



|                                                        |                         |
|--------------------------------------------------------|-------------------------|
|                                                        | <i>Chrome</i>           |
| <b>No. 164</b> 6½" x 14" Choice of Mahogany or Lacquer | \$75.00                 |
| <b>No. 165</b> 6½" x 15" Choice of Mahogany or Lacquer | 77.00                   |
| <b>No. 166</b> 8" x 15" Choice of Mahogany or Lacquer  | 80.00                   |
|                                                        | <i>Excise Tax Extra</i> |
| Pearl Finishes, Add                                    | \$10.00                 |
| Gut Snares, Extra                                      | 2.00                    |

## CONCERT HALL MODEL SNARE DRUMS

Concert Hall Model Snare Drums are the most popular in the low priced market. The Rapid snare strainer, six separate tension self-aligning lugs, tone control, Rim Shot counterhoops, molded 3-ply veneer shell with solid maple inside reinforcing hoops, and twelve wire snappy snares give it a superb tone. Sound King plastic heads are standard, unless calf is requested.

|                                                        |                         |
|--------------------------------------------------------|-------------------------|
|                                                        | <i>Chrome</i>           |
| <b>No. 167</b> 6½" x 14" Choice of Mahogany or Lacquer | \$66.00                 |
| <b>No. 168</b> 6½" x 15" Choice of Mahogany or Lacquer | 69.00                   |
| <b>No. 169</b> 8" x 15" Choice of Mahogany or Lacquer  | 72.00                   |
|                                                        | <i>Excise Tax Extra</i> |
| Pearl Finishes, Add                                    | \$10.00                 |
| Gut Snares, Extra                                      | 2.00                    |



ILLUSTRATED FINISH—BLUE AND SILVER

**NEW**

*Slingerland*

**SOUND KING  
TOM TOMS**



ILLUSTRATED FINISH  
SPARKLING BLUE PEARL  
NO. 1405



The new, beautiful rim-shot counterhoop\* gives you the best stick protection and the strongest hoops in the industry—guarantees even tension and better tone. Slingerland Drums have 30% more non-ferrous (non-rusting) metals than most other makes.

\*PATENT No. 2,779,227. Holders not included. Please specify what model holders you desire and whether they are to be attached or not.

The new Slingerland tom toms are the finest instruments of their type. Rim shot metal counterhoops overcome the use of collar hooks, also unsightly flesh hoops. The counterhoops are the thickest hoops on the market today which give you a solid tone and preserve your sticks. These drums contain over 30% non-ferrous (non-rusting) materials than average tom toms which guarantee, for you, their lasting beauty and performance. Supplied with Sound King plastic heads unless calf is requested.

Tone Control Included

Please Specify Type of Holder Desired on 8"x12" & 9"x13" Toms



ILLUSTRATED IN  
MARINE PEARL

**SEPARATE TENSION CHOICE OF LACQUER COLORS**

|          |                                      | <i>Chrome</i> |
|----------|--------------------------------------|---------------|
| No. 1415 | 8" x 12" Head.....                   | \$ 60.00      |
| No. 1402 | 9" x 13" Head.....                   | 62.00         |
| No. 1404 | 14" x 14" Head. 3 legs attached..... | 77.00         |
| No. 1406 | 16" x 16" Head. 3 legs attached..... | 82.00         |
| No. 1471 | 16" x 18" Head. 4 legs attached..... | 98.00         |
| No. 1476 | 18" x 20" Head. 4 legs attached..... | 112.00        |

*Excise Tax Extra*

**SEPARATE TENSION CHOICE OF PEARL FINISHES**

|          |                                      | <i>Chrome</i> |
|----------|--------------------------------------|---------------|
| No. 1411 | 8" x 12" Head.....                   | \$ 67.00      |
| No. 1401 | 9" x 13" Head.....                   | 69.00         |
| No. 1403 | 14" x 14" Head. 3 legs attached..... | 92.00         |
| No. 1405 | 16" x 16" Head. 3 legs attached..... | 97.00         |
| No. 1470 | 16" x 18" Head. 4 legs attached..... | 114.00        |
| No. 1475 | 18" x 20" Head. 4 legs attached..... | 132.00        |

*Excise Tax Extra*

**STANDARD MODEL TOM TOMS**

Separate tension center lug, rim shot counter hoops and tone control.  
Sound King Plastic Heads

**CHOICE OF LACQUER COLORS**

|          |                               | <i>Chrome</i> |
|----------|-------------------------------|---------------|
| No. 1416 | 8" x 12" Head.....            | \$50.00       |
| No. 1417 | 9" x 13" Head.....            | 52.00         |
| No. 1418 | 12" x 15" Head, Legs att..... | 63.00         |

*Excise Tax Extra*

**CHOICE OF PEARL FINISHES**

|          |                               | <i>Chrome</i> |
|----------|-------------------------------|---------------|
| No. 1419 | 8" x 12" Head.....            | \$58.00       |
| No. 1420 | 9" x 13" Head.....            | 60.00         |
| No. 1421 | 12" x 15" Head, Legs att..... | 78.00         |

*Excise Tax Extra*

PLEASE SPECIFY TYPE OF HOLDER DESIRED ON  
8" x 12" AND 9" x 13" TOMS



NO. 1421

RAY McKINLEY  
TOM TOM HOLDER

It is the Champion of Champions. Tilts in all directions—bolted to drum shell. Just slip tom tom off and turn bracket down. Remains permanently on drum. Guaranteed satisfaction. Made in two different lengths, one for 22" x 24" bass drums and one for 18" x 20" bass drums.

|                                        |                          |
|----------------------------------------|--------------------------|
| No. 1725 for 22" x 24" bass drums..... | <i>Chrome</i><br>\$14.00 |
| No. 172L for 18" x 20" bass drums..... | 14.00                    |



NO. 172

**NEW PUSH-BUTTON  
TOM TOM LEGS**

Just push the button to adjust, release the button and the leg stays at that position—it can not slip.

The beautiful die cast housing is hand buffered to a high lustre.

This is by far the finest set of tom tom legs on the market.

|      |                   | <i>Chrome</i> |
|------|-------------------|---------------|
| 1290 | For 16" x 16".... | \$ 9.00       |
| 1292 | For 16" x 18".... | 11.60         |
| 1292 | For 18" x 20".... | 11.60         |



NO. 1419



# TOM TOM AND BASS DRUM Accessories

## TOM TOM HOOP HOLDER

Heavy duty Ratchet Tom Tom Holder.

No. 1286—Holder Chromium.....\$6.00



## NEW TOM TOM HOLDER

This holder has all the adjustments necessary for the easy playing position of the Tom. Fastens to our No. 589 Trap Rail—easy to assemble or dismount and stays in position when in use.

No. 160—Tom Holder Chrome.....\$6.00  
No. 589—Rail Chrome.....\$5.50



## NEW DOUBLE TOM TOM HOLDER

Telescopes into Bass Drum. Top ratchet adjusts to any angle. Will not slip. Includes diamond plates for Tom Toms.

No. 171 Chrome.....\$16.00



## RAY McKINLEY Internal Tone Control Bass Drum Muffler

Yes sir! Here it is. At last the perfected internal tone control that gets the "just right" response from your bass drum. EVERY DRUMMER SHOULD HAVE ONE.

No. 933 Chrome plated.....\$6.00



## DELUXE "SHUR-GRIP" BASS DRUM MUFFLER

This muffler is adjustable to fit any bass drum and may be placed in varied positions to obtain a full resonant tone.

No. 935 Chrome.....\$5.50



## BASS DRUM ANCHOR

New item to hold bass drum against push of beat. Installed on front—audience side—with reversible spike or rubber tops. Strong, solid and practical.

Nickel  
No. 734 Drum Anchor \$4.50



## BASS DRUM STAND

All metal stand. Chrome finish, rigid in construction and in service. Folds compactly, holds any width bass drum and is adjustable for height. Carefully made, will not creep.

No. 900.....\$18.00



## NEW TELESCOPIC SPURS

(Pat. No. 2,919,618)

The forward angle prevents your bass drum from walking! The downward angle gives your bass twice as much support as other spurs!

No. 727 Pair Chrome..\$6.50



## SHELL MOUNT SPURS

SLIDE IN MODEL

Very rigid, sturdy shell mount spurs that slide into shell, out of the way. Drill hole through shell to locate spurs at maximum spread. Tighten with lock nut inside shell. Reversible spike or rubber tip.

No. 1280-C Slide In spurs, shell mount, chrome, pair.....\$5.00



## GIANT SPURS

They are made of heavy steel rod die stamped. Easily adjustable as to angle and height.

No. 721 Chrome. Pr. \$4.00



## ECONOMO SPURS

Practical, inexpensive spurs, clamp to hoop, easy turning screw, and with wide set long spur for spread. Chrome plated only.

No. 1279 Economo Spurs pair.....\$3.00



## RUBBER SPUR ANCHOR

Large rubber disc with countersunk steel center—helps drum stay put on slippery floors, also protects floors and rugs.

No. 1281 Rubber Spur Anchor.....pair \$4.50



# Slingerland

## SOUND-KING MODEL

### Separate Tension

Sound King Bass Drums give that great sound you have been looking for. The sound is built into them. Better tensioning is possible because they have more tension lugs than some other makes. Note the new streamlined hooks, tension handles and lugs. Muffler strap and a moleskin patch for the pedal beater are standard. Sound King plastic heads are standard, unless calf is requested. The shells are molded 3-ply veneer with solid maple inside reinforcing rims.

#### PRICES INCLUDES INLAID HOOPS

|          |                                             | Chrome   |
|----------|---------------------------------------------|----------|
| No. 311  | 14" x 18" Choice of Lacquer Finishes        | \$ 88.00 |
| No. 312  | 14" x 18" Choice of Pearl Finishes          | 119.00   |
| No. 324A | 12" x 20" Choice of Lacquer, 16 Lugs        | 92.00    |
| No. 323A | 12" x 20" Choice of Pearl Finishes, 16 Lugs | 122.00   |
| No. 324  | 14" x 20" Choice of Lacquer, 16 Lugs        | 94.00    |
| No. 323  | 14" x 20" Choice of Pearl Finishes, 16 Lugs | 124.00   |
| No. 336A | 12" x 22" Choice of Lacquer, 20 Lugs        | 97.50    |
| No. 335A | 12" x 22" Choice of Pearl Finishes, 20 Lugs | 127.50   |
| No. 336  | 14" x 22" Choice of Lacquer, 20 Lugs        | 102.00   |
| No. 335  | 14" x 22" Choice of Pearl Finishes, 20 Lugs | 132.00   |
| No. 348  | 12" x 24" Choice of Lacquer                 | 112.00   |
| No. 349  | 12" x 24" Choice of Pearl Finishes          | 142.00   |
| No. 316  | 14" x 24" Choice of Lacquer                 | 112.00   |
| No. 306A | 14" x 24" Choice of Pearl Finishes          | 142.00   |

Excise Tax Extra

## ARTIST MODEL

### Single Tension

Artist Model Bass Drums are single tension, which makes it possible for their low price. Supplied with new streamlined hooks, tension handles and lugs. Muffler strap and moleskin patch for pedal beater are standard on models up to 22" diameter. Sound King plastic heads are standard, unless calf is requested. Shells are molded 3-ply veneer with solid maple inside reinforcing hoops. Truly a fine value.

|          |                                         | Chrome   |
|----------|-----------------------------------------|----------|
| No. 331  | 12" x 20" Choice of Mahogany or Lacquer | \$ 76.00 |
| No. 332  | 14" x 20" Choice of Mahogany or Lacquer | 77.50    |
| No. 333  | 12" x 22" Choice of Mahogany or Lacquer | 84.00    |
| No. 334  | 14" x 22" Choice of Mahogany or Lacquer | 86.00    |
| No. 337A | 12" x 24" Choice of Mahogany or Lacquer | 96.00    |
| No. 339A | 14" x 24" Choice of Mahogany or Lacquer | 96.00    |
| No. 339  | 14" x 26" Choice of Mahogany or Lacquer | 104.00   |
| No. 341  | 14" x 28" Choice of Mahogany or Lacquer | 106.00   |
| No. 342  | 14" x 30" Choice of Mahogany or Lacquer | 130.00   |
| No. 343  | 16" x 30" Choice of Mahogany or Lacquer | 132.00   |

Excise Tax Extra

Choice of Pearl Shells and Inlaid Hoops, Add. . . . \$ 30.00

Choice of Pearl Inlaid Counter Hoops, on Lacquer Models, Add. . . . 3.00



ILLUSTRATED IN MARINE PEARL



ILLUSTRATED IN BLUE & SILVER LACQUER



# BASS DRUMS

## CONCERT-KING MODEL

### Separate Tension

Concert King Model Bass Drums are famous for their outstanding tone and carrying power. The twin rows of separate tension lugs gives more even tensioning of each head. Note the new streamlined hooks, tension handles and lugs. Supplied with Sound King plastic heads unless calf is requested. All drums 34" and larger are supplied with calf heads. Shells are molded 3-ply veneer with solid maple inside reinforcing hoops.

|                                                             | <i>Chrome</i>   |
|-------------------------------------------------------------|-----------------|
| <b>No. 348</b> 12" x 24" Choice of Mahogany or Lacquer..... | <b>\$109.00</b> |
| <b>No. 316</b> 14" x 24" Choice of Mahogany or Lacquer..... | 109.00          |
| <b>No. 313</b> 14" x 26" Choice of Mahogany or Lacquer..... | 120.00          |
| <b>No. 317</b> 14" x 28" Choice of Mahogany or Lacquer..... | 124.00          |
| (For groups of 30 pieces or less)                           |                 |
| <b>No. 318</b> 14" x 30" Choice of Mahogany or Lacquer..... | 138.50          |
| <b>No. 319</b> 16" x 30" Choice of Mahogany or Lacquer..... | 140.50          |
| (For groups up to 40 pieces)                                |                 |
| <b>No. 321</b> 16" x 32" Choice of Mahogany or Lacquer..... | 150.00          |
| (For groups up to 55 pieces)                                |                 |
| <b>No. 322</b> 16" x 34" Choice of Mahogany or Lacquer..... | 160.00          |
| (For groups up to 75 pieces)                                |                 |
| <b>No. 315</b> 16" x 36" Choice of Mahogany or Lacquer..... | 174.00          |
| (For groups over 75 pieces)                                 |                 |
| <b>No. 320</b> 18" x 40" Choice of Mahogany or Lacquer..... | <b>210.00</b>   |

*Excise Tax Extra*

|                                                                   |                 |
|-------------------------------------------------------------------|-----------------|
| Choice of Pearl Shells and Inlaid Hoops, Add..                    | <b>\$ 30.00</b> |
| Choice of Pearl Inlaid Counter Hoops, on Lacquer Models, Add..... | 3.00            |

## STANDARD SCHOOL MODEL

### Single Tension

The Standard School Model Bass Drums with their low price are a fine value. The single tension stud center supports make it possible to price this drum so low. Shells are molded 3-ply veneer with solid maple inside reinforcing hoops. Note the new streamlined hooks and tension handles. Supplied with Sound King plastic heads unless calf is requested.

|                                                             | <i>Chrome</i>   |
|-------------------------------------------------------------|-----------------|
| <b>No. 360</b> 12" x 20" Choice of Mahogany or Lacquer..... | <b>\$ 72.00</b> |
| <b>No. 361</b> 14" x 20" Choice of Mahogany or Lacquer..... | 73.50           |
| <b>No. 362</b> 14" x 22" Choice of Mahogany or Lacquer..... | 88.00           |
| <b>No. 363</b> 14" x 24" Choice of Mahogany or Lacquer..... | 92.00           |
| <b>No. 364</b> 14" x 26" Choice of Mahogany or Lacquer..... | 96.00           |
| <b>No. 365</b> 14" x 28" Choice of Mahogany or Lacquer..... | 100.00          |

*Excise Tax Extra*

|                                        |                |
|----------------------------------------|----------------|
| Choice of Pearl Inlaid Hoops, Add..... | <b>\$ 3.00</b> |
|----------------------------------------|----------------|



ILLUSTRATED IN SPARKLING GOLD PEARL



ILLUSTRATED IN MAHOGANY

# AMERICAN DRUMS

by

# Slingerland



**No. 1134** Deluxe professional conga two-tone natural wood finish, chrome bands, large round barrel shaped—heavy mule hide head. Size 30" deep by 11½" head.  
Only ..... \$52.50



No. 280

## CONGAS

Size 27" x 12"

Congas are an instrument which have gained popularity among professional musicians. There are many good bands who are now using the single Conga which is light and easy to handle. There has also been a great demand for them in Oriental bands. Calf Heads.



No. 289



## MARACA STICKS THE DRUM STICK WITH A BUILT-IN MARACA

For all Latin American effects. Rumbas, Sambas, Mombos sound better with maraca sticks. Hold and use as timbale sticks for best results.

**No. 1151** Maraca sticks, pr. \$3.60

| SINGLE CONGA                                             |               |
|----------------------------------------------------------|---------------|
| <b>No. 280</b> Choice of Lacquer                         | <i>Chrome</i> |
| Finishes.....                                            | \$ 60.00      |
| <b>No. 281</b> Choice of Pearl                           |               |
| Finishes.....                                            | 70.00         |
| <i>(Complete with Sling)</i>                             |               |
| <i>Federal Tax Extra</i>                                 |               |
| <b>No. 282</b> Mackintosh Cover for<br>Single Conga..... | \$15.00       |

| DOUBLE CONGA                        |               |
|-------------------------------------|---------------|
| <b>No. 290</b> Choice of Lacquer    | <i>Chrome</i> |
| Finishes.....                       | \$125.00      |
| <b>No. 289</b> Choice of Pearl      |               |
| Finishes.....                       | 145.00        |
| <i>(Complete with Chrome Stand)</i> |               |
| <i>Fed. Tax Extra</i>               |               |



No. 1114



## GOURD (MEXICAN WEE-RO)

Hand-turned and hand painted, highly polished.

**No. 1150** Gourd, with scraper..... \$5.25



## CLAVES

Another native Cuban rhythm accessory of importance. Claves are made in two sizes, to produce the correct native tone.

**No. 1149** Cuban Claves, per pr. \$2.50

## THE NEW HAND-MADE DELUXE MEXICAN MARACAS

The most artistic hand-made production of Old Mexico. Made of native woods, light, strong, properly weighted and balanced. 9 inches long overall, ball is 4½ inches long, and 3½ inches in diameter.

**No. 1114** Slingerland De Luxe, Mexican Maracas, pr. \$4.00

# Become a Better Drummer **SOONER**

PROVIDE YOURSELF WITH THE PROPER



**KIT No. 27F**

*Chrome*  
FINISH OF SNARE DRUM SPECIAL PRICE  
MAHOG. OR LACQUER \$111.00  
CHOICE OF PEARL 116.00

*Excise Tax Extra*

*Complete Drum Kit Includes*

|           |                                                                            |                 |
|-----------|----------------------------------------------------------------------------|-----------------|
| No. 153   | 5½" x 14" Sound King Snare Drum, Mahogany or Lacquer, chrome.....          | \$ 85.00        |
| No. 467   | Hard Shell Case, Plush Lined, Covered with Pyroxylin Coated Alligator..... | 24.00           |
| No. 802   | Chrome Flush Base Snare Drum Stand                                         | 12.80           |
| No. 1186  | Harr Drum Method No. 1.....                                                | 1.50            |
| No. 956K  | Practice Pad with Extension Rod for Stand .....                            | 4.50            |
| No. 728GK | Brushes, Rubber Handles.....pair                                           | 1.75            |
| ONE PAIR  | Silicone treated drum sticks.....                                          | 1.20            |
|           | <b>Total Value .....</b>                                                   | <b>\$130.75</b> |

**KIT No. 26F**

*Chrome*  
FINISH OF SNARE DRUM SPECIAL PRICE  
MAHOG. OR LACQUER \$ 89.50  
CHOICE OF PEARL 94.50

*Excise Tax Extra*

*Complete Drum Kit Includes*

|           |                                                                            |                 |
|-----------|----------------------------------------------------------------------------|-----------------|
| No. 162   | 5½" x 14" Mahogany or Lacquer, chrome plated snare drum .....              | \$ 54.00        |
| *No. 467  | Hard Shell Case, Plush Lined, Covered with Pyroxylin Coated Alligator..... | 24.00           |
| No. 802   | Chrome Flush Base Snare Drum Stand                                         | 12.80           |
| *No. 1186 | Harr Drum Method No. 1.....                                                | 1.50            |
| No. 956K  | Practice Pad with Extension Rod for Stand .....                            | 4.50            |
| No. 728GK | Brushes, Rubber Handles.....pair                                           | 1.75            |
| ONE PAIR  | Silicone treated drum sticks.....                                          | 1.20            |
|           | <b>Total Value .....</b>                                                   | <b>\$ 99.75</b> |



**KIT No. 29F**

*Chrome*  
FINISH OF SNARE DRUM SPECIAL PRICE  
MAHOG. OR LACQUER \$ 75.00  
CHOICE OF PEARL 80.00

*Excise Tax Extra*

Now supplied with the new Modern Kit case, trimmed with chrome and plywood reinforced on four sides. The new compact design makes it possible to ship this kit via parcel post.

*Complete Drum Kit Includes*

|           |                                                               |                |
|-----------|---------------------------------------------------------------|----------------|
| No. 162   | 5½" x 14" Mahogany or Lacquer, chrome plated snare drum ..... | \$54.00        |
| *No. 479  | Modern Kit Case with Hinged Top.....                          | 16.00          |
| No. 801   | Professional Snare Drum Stand; Chrome                         | 9.50           |
| *No. 1186 | Slingerland Drum Method No. 1.....                            | 1.50           |
| No. 956   | Practice Pad .....                                            | 2.50           |
| ONE PAIR  | Silicone treated drum sticks.....                             | 1.20           |
|           | <b>Total Value .....</b>                                      | <b>\$84.70</b> |

# with **NEW** *Slingerland* **DRUM KITS**

INSTRUMENT AND ASSURE YOUR SUCCESS



**KIT No. 25F**

*Chrome*  
SPECIAL PRICE

**COMPLETE KIT \$ 85.00**

*Excise Tax Extra*

*Complete Drum Kit Includes*

|           |                                                    |                |
|-----------|----------------------------------------------------|----------------|
| No. 140   | 5½" x 14" Aluminum Shell, chrome plated snare drum | \$65.00        |
| *No. 479  | Modern Kit Case with Hinged Top                    | 16.00          |
| No. 801   | Snare Drum Stand, chrome                           | 9.50           |
| *No. 1186 | Slingerland Drum Method No. 1                      | 1.50           |
| No. 956   | Practice Pad                                       | 2.50           |
| ONE PAIR  | Silicone treated drum sticks                       | 1.20           |
|           | <b>Total Value</b>                                 | <b>\$95.70</b> |



**KIT No. 30**

*Chrome*  
FINISH OF SNARE DRUM SPECIAL PRICE  
MAHOG. OR LACQUER \$ 68.00  
CHOICE OF PEARL 73.00

*Excise Tax Extra*

*Complete Drum Kit Includes*

|           |                                                         |                |
|-----------|---------------------------------------------------------|----------------|
| No. 158   | 5½" x 14" Mahogany or lacquer, chrome plated snare drum | \$49.00        |
| *No. 479  | Modern Kit Case with Hinged Top                         | 16.00          |
| No. 801   | Snare Drum Stand, chrome                                | 9.50           |
| *No. 1186 | Slingerland Drum Method No. 1                           | 1.50           |
| No. 956   | Practice Pad                                            | 2.50           |
| ONE PAIR  | Silicone treated drum sticks                            | 1.20           |
|           | <b>Total Value</b>                                      | <b>\$79.70</b> |

## PARADE DRUM KITS

**KIT No. 31**

*Chrome*  
FINISH OF SNARE DRUM SPECIAL PRICE  
MAHOG. OR LACQUER \$ 56.00

*Excise Tax Extra*

*Complete Drum Kit Includes*

|          |                                                                                   |                |
|----------|-----------------------------------------------------------------------------------|----------------|
| No. 574  | 10" x 14" (8 rod) Mahogany or lacquer, chrome parade drum, sticks and white sling | \$45.00        |
| *No. 471 | 10" x 14" Fibre Case                                                              | 14.90          |
|          | <b>Total Value</b>                                                                | <b>\$59.90</b> |

**KIT No. 32**

*Chrome*  
FINISH OF SNARE DRUM SPECIAL PRICE  
MAHOG. OR LACQUER \$ 53.00

*Excise Tax Extra*

*Complete Drum Kit Includes*

|          |                                                                                   |                |
|----------|-----------------------------------------------------------------------------------|----------------|
| No. 575  | 10" x 14" (6 rod) Mahogany or lacquer, chrome parade drum, sticks and white sling | \$42.00        |
| *No. 471 | 10" x 14" Fibre case                                                              | 14.90          |
|          | <b>Total Value</b>                                                                | <b>\$56.90</b> |



**KIT NO. 31**

# AVEDIS ZILDJIAN

Genuine

Cymbals



SPECIFY THICKNESS—EXTRA THIN—PAPER THIN—THIN HI-HAT—MEDIUM—CONCERT BAND

TYPES—BE BOP, RIDE OR BOUNCE, SIZZLE WITH RIVETS

|           |     | Each    |           |     | Each    |
|-----------|-----|---------|-----------|-----|---------|
| *No. Z-8  | 8"  | \$ 9.00 | *No. Z-17 | 17" | \$40.00 |
| *No. Z-10 | 10" | 15.00   | *No. Z-18 | 18" | 45.00   |
| *No. Z-12 | 12" | 22.00   | *No. Z-19 | 19" | 50.00   |
| *No. Z-13 | 13" | 26.00   | *No. Z-20 | 20" | 55.00   |
| *No. Z-14 | 14" | 30.00   | *No. Z-22 | 22" | 65.00   |
| *No. Z-15 | 15" | 33.00   | *No. Z-24 | 24" | 75.00   |
| *No. Z-16 | 16" | 37.00   |           |     |         |

Plus Excise Tax

## NEW ADJUSTABLE THROW-OFF CYMBAL SIZZLER

Sizzler On

Sizzler Off



No. 730 Cymbal Sizzler .....\$3.60

## AVEDIS ZILDJIAN GONGS

The only gongs made anywhere in the world by Zildjian and their 300-year-old process.

Available in thin (crashy), medium and heavy (deep and mellow), weights and in sizes 24" through 28", in even numbered diameters.

|            |     |          |            |     |        |
|------------|-----|----------|------------|-----|--------|
| *No. G-924 | 24" | \$ 90.00 | *No. G-926 | 26" | 100.00 |
| *No. G-928 | 28" | 120.00   |            |     |        |

(All prices list plus Federal Tax)

### GONG STAND

Circular ring on folding Hexapod base.

No. 920 .....\$24.00

Specify diameter of gong when ordering

# ALLEGIAN

Genuine

Cymbals



SPECIFY THICKNESS—EXTRA THIN—PAPER THIN—THIN HI-HAT—MEDIUM—CONCERT BAND

TYPES—BE BOP, RIDE OR BOUNCE, SIZZLE WITH RIVETS

|           |     | Each    |           |     | Each    |
|-----------|-----|---------|-----------|-----|---------|
| *No. A-8  | 8"  | \$ 7.00 | *No. A-14 | 14" | \$24.00 |
| *No. A-9  | 9"  | 8.00    | *No. A-15 | 15" | 27.00   |
| *No. A-10 | 10" | 11.00   | *No. A-16 | 16" | 30.00   |
| *No. A-11 | 11" | 13.00   | *No. A-17 | 17" | 33.00   |
| *No. A-12 | 12" | 17.00   | *No. A-18 | 18" | 38.00   |
| *No. A-13 | 13" | 21.00   | *No. A-19 | 19" | 42.00   |

Plus Excise Tax

## Genuine TUSCANESE Cymbals

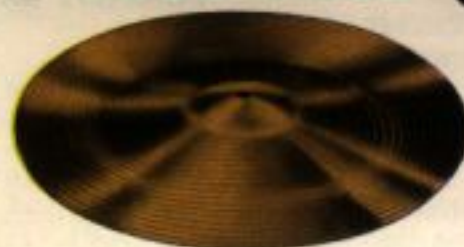

Tuscanese Cymbals are the products of artisans who are descendents of craftsmen who spun cymbals for the military bands of the eighth century. These cymbals, imported from Europe, have an improved tonal brilliance—greater "cut thru," and a blending quality that cannot be surpassed.

|          |     |                 |        |
|----------|-----|-----------------|--------|
| No. 1800 | 10" | Thin only       | \$6.50 |
| No. 1801 | 11" | Thin only       | 7.90   |
| No. 1802 | 12" | Thin only       | 8.50   |
| No. 1803 | 13" | Thin only       | 12.00  |
| No. 1804 | 14" | Medium and Thin | 18.50  |
| No. 1815 | 15" | Medium and Thin | 21.80  |

Plus Excise Tax

## Slingerland SPUN BRASS CYMBALS



No. 919

Spun from tempered brass. Owing to price fluctuation in brass, the prices of these cymbals are subject to change without notice.

|         |     |        |          |     |                 |
|---------|-----|--------|----------|-----|-----------------|
| No. 919 | 7"  | \$1.85 | No. 1056 | 11" | \$5.75          |
| No. 750 | 8"  | 2.80   | No. 753  | 13" | 7.50            |
| No. 751 | 10" | 4.00   |          |     | Plus Excise Tax |

## LEATHER CYMBAL POUCHES

|         |     |                      |         |
|---------|-----|----------------------|---------|
| No. 622 | 14" | Leather Cymbal Pouch | \$17.70 |
| No. 623 | 15" | Leather Cymbal Pouch | 18.50   |
| No. 624 | 16" | Leather Cymbal Pouch | 20.70   |

Genuine leather, crescent shape, with leather carrying strap. Specify russet or black color.

## SIZZLE CYMBAL

No. 1068 11" Sizzle Cymbal .....\$6.20

Made in spun brass with six nickel plated sizzlers. One size only.

Plus Excise Tax



No. 1068

# THE *Best* IN CYMBAL HOLDERS

## CYMBAL HOLDER FEATURES

- **FRICITION CLAMP** does not mar cymbal arm
- **LARGE TIGHTENING HANDLE**
- **STEEL ALLOY**
- **ADJUSTABLE RATCHET**

|                             | <i>Chrome</i> |
|-----------------------------|---------------|
| No. 761-12 Length 12" . . . | \$5.10        |
| No. 761-14 Length 14" . . . | 5.35          |
| No. 761-16 Length 16" . . . | 5.35          |
| No. 761-18 Length 18" . . . | 5.35          |
| No. 761-21 Length 21" . . . | 5.50          |
| No. 590-12 Length 12" . . . | 5.90          |
| No. 590-14 Length 14" . . . | 5.90          |
| No. 590-16 Length 16" . . . | 6.00          |
| No. 590-18 Length 18" . . . | 6.10          |
| No. 590-21 Length 21" . . . | 6.10          |

Prices include holder, clamp and cymbal arm.

|                                                                       |        |
|-----------------------------------------------------------------------|--------|
| No. 761 Hoop clamps complete (less the arm) for cymbal holders . . .  | \$4.50 |
| No. 760 Chrome cymbal arm only for No. 761 (specify length) . . . . . | 2.00   |
| No. 590 Shell Base only . . .                                         | 3.00   |
| No. 591 Knurled cymbal arm for No. 590 (specify length) . . . . .     | 2.50   |

### NEW SHELL MOUNT CYMBAL HOLDER

Here is the newest of the modern cymbal holders. It has a built-in cymbal tilter and is adjustable for height. Complete in one assembly, so it's easy to mount, handle, pack away and best of all, it is very sturdy.

Made standard for shell mounting. But it can also be used with hoop clamps for rim mounting. This is IT, a MUST for the drummer today.

**No. 599 Complete Shell Mount Tilt Cymbal Holder, Chrome . . . . . \$7.50**

**No. 600 Chrome Upper Adjustable Section only . . . 4.00**  
If desired for hoop mounting, specify below:

**No. 599-H Tilt Holder complete with Hoop Clamps, Chrome . . . . . \$7.50**

**No. 592 Knurled Angle Arm for No. 599 \$2.00**

### BASS DRUM CYMBAL HOLDER

Adjustable, felt padded cymbal block that will not mar the shell. "Shur-Grip" clamps, pressed steel arms. Heavily chrome plated. A positive holder.

**No. 1113 Chrome plated . . \$6.00**

### FLOOR CYMBAL STANDS

**No. 33F** flush base cymbal stand has our Deluxe Cymbal Tilter built-in. Adjustable in height from 23" to 50", folds compactly to 22 3/4".

**No. 33F Chrome . . . . . \$11.50**

**No. 33B** Cymbal Stand is strong and sturdy. Adjusts in height from 22" to 48". Folds compactly to 22".

**No. 33B Chrome . . . . . \$8.00**

### NEW CYMBAL TILTER

Can't slip—beautifully hand-polished and buffed aluminum die casting. Tilts cymbal at suitable angles. Simple, effective, practical. Just slip over standard cymbal rod top—the finest tilter made.

**No. 1666 Cymbal Tilter . . \$1.75**

### NEW TELESCOPIC CYMBAL HOLDER

The New Slingerland Telescopic Cymbal Holder slides conveniently into the bass drum. Just drill a 1/2" hole in the bass drum shell. The cymbal holder as illustrated is best suited for mounting in the center of the bass drum. However, if you attach the **No. 1666** cymbal tilter to it, it can be mounted on the side of the bass drum.

**No. 597 Chrome Telescopic Cymbal Holder . . . . . \$5.00**

### HAND CYMBAL HOLDERS

Lambs Wool Cymbal Pads and Horsehide Straps covered with Lambs Wool. Finest straps and Pads made. Absorb all shocks.

**No. 1155 Lambs Wool Straps, each . . . . . \$1.25**

**No. 1156 Lambs Wool Pads, each . . . . . 2.25**

**No. 923 Horsehide Strap, each . . . . . .50**

Naugahyde Pads, heavily padded and strong, Horsehide straps.

**No. 923 Strap only, each . . \$ .50**

**No. 825 Pad only, each . . . 1.00**

Wood Cymbal Handles with Leather Strap and Pad. Very popular with Drum Corps.

**No. 758A Per pair . . . . . \$3.50**

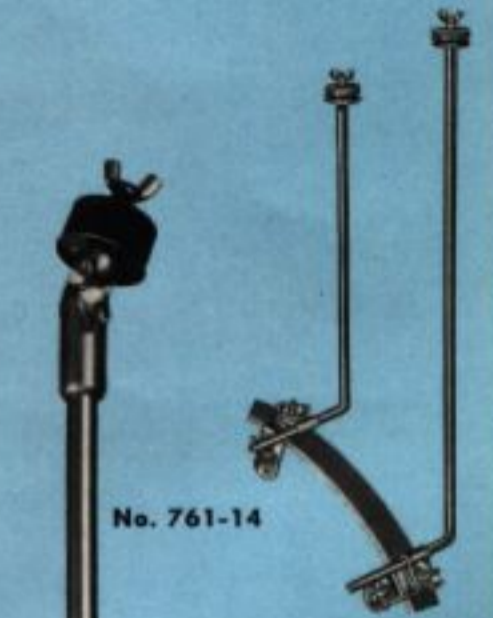

No. 761-14

No. 761-21



No. 599



No. 1113



No. 33F



No. 33B



No. 590-14



\$5.00  
TILTER  
EXTRA



\$5.00  
TILTER  
EXTRA



# New! FLUSH BASE STANDS THAT SET UP LIGHTNING FAST



Height adjustment clutch—precision machined wing screw that exerts pressure on bronze split bushing which grips around entire tube so that it cannot slip.



Ratchet that cannot slip for adjusting angle at 1° intervals—no other stand has this minute adjustment.



Easy setup, just fold the three legs down, tighten the one large wing nut and you are all set.



**BUCK ROGERS SNARE STAND**

Chrome  
No. 805. For 13" and 14" drums ..... \$19.50  
No. 805B. For 15" and 16" drums .... 20.50



**FLUSH BASE HI-HAT**

Chrome  
No. 803.....\$19.80



**FLUSH BASE SNARE STAND**

Chrome  
No. 802.....\$12.80



**FLUSH BASE CYMBAL STAND**

Chrome  
No. 33F.....\$11.50

## KRUPA THRONE



Strong, rigid drummer's chair; 24" high; comfortable, cushioned leather covered top, round chair. Open at bottom; lots of room for accessories. Size 24" x 13".

No. 880 Choice of Pearl.....\$40.00  
No. 881 Choice of Lacquer..... 30.00

## DRUMMERS FOLDING THRONE



A sturdy throne; foam rubber seat covered with corduroy.  
No. 7272 Throne: ....\$16.75  
No. 7274 Back rest, extra..... 2.25

## NEW ROCKET THRONE



The new Rocket Throne is the throne you have been waiting for! It is without doubt the strongest, most beautiful, finest designed throne ever built. All parts are hand polished and triple-chrome plated. The seat is padded with sponge rubber and covered with tan naugahyde.

No. 838 Chrome Throne.....\$20.00

# New NO. 804 HI-HAT

WITH THE DIRECT PULL\*



No. 804

## NO. 801 PROFESSIONAL STAND



No. 801

ADJUSTABLE  
RUBBER COVERED  
STEEL ARMS

POSITIVE  
NON-SLIP  
HEIGHT ADJUSTMENT

STURDY  
STEEL LEGS

Heavy duty type. Has rubber covered arms to protect the plating or finish on the hoops while giving a more positive grip. Rubber feet prevent slipping on smooth floors. Adjustable as to angle of inclination and height. May be used on any 14", 15" and 16" snare drum.

No. 801 Chrome Professional Stand..... \$ 9.50

No. 897 Nickel Student Stand (not illustrated)..... 5.50

### HI-HAT ANCHOR

Attachable to front leg of sock pedals, either rubber or spike slide to prevent forward movement and slippage.

No. 1628 Each, nickel only..... \$ 1.25

This new Hi-Hat with direct pull, nylon bearings and built-in spur is by far the best, easiest action, quietest Hi-Hat ever made.

No. 804 Hi-Hat, Chrome..... \$22.00

Patent No. 3147661

## SUPER-GRIP DRUM STANDS



No. 1382

A very popular stand with top Professionals. The snare drum and the stand are locked together as a solid unit. Powerful screw action closes the arms to drum with a vise grip. Cannot wiggle or wobble—and makes fortes, rim shots, and solo work a pleasure. Sets to any angle and folds compactly.

No. 1382 Sure Grip Stand. (Holds 13" and 14" drums.) Nickel..... \$19.00

No. 1382C Chrome..... 24.50

No. 1383 Sure Grip Stand. (Holds 15" and 16" Drums.) Nickel..... 20.00

No. 1383C Chrome..... 25.50

## ARTIST HI-HAT PEDAL



No. 835

A long-time favorite with professionals. Fast, frictionless action, folds compactly.

No. 835 Artist Hi-Hat, Chrome..... \$18.00

## KRUPA HI-HAT PEDAL

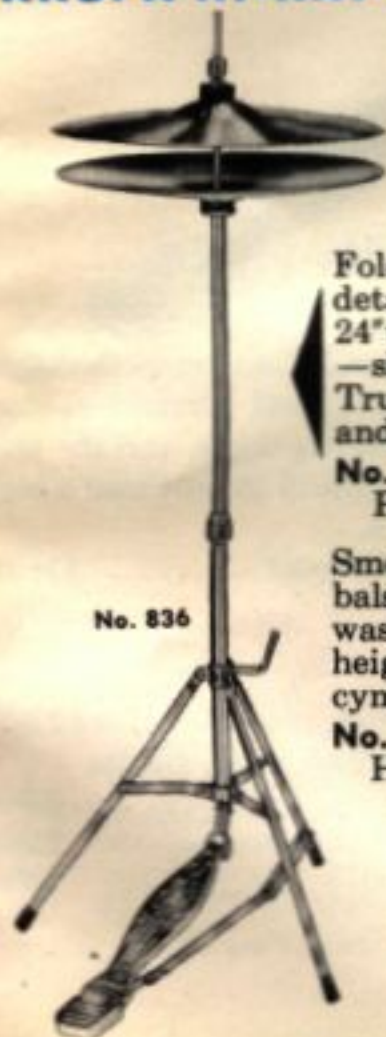

No. 836

Folds compactly to 23½" without detaching any parts — adjustable 24" to 36". Rod pulls direct at bottom — slip proof clutch adjusts cymbals. Truly a fine Hi-Hat—strong, rigid and dependable.

No. 836 Krupa Hi-Hat Pedal, Chrome..... \$18.00

Smooth, easy noiseless action. Cymbals can be spaced loose or tight for washy or solid effects. Adjustable height, 30" to 33". Stand and pedal, cymbals not included.

No. 837 Professional Hi-Hat, Chrome..... \$18.00

## PROFESSIONAL HI-HAT PEDAL

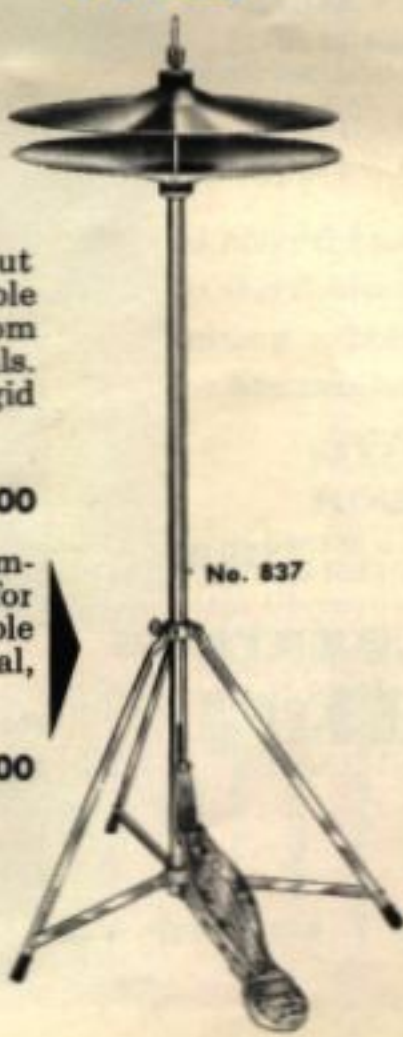

No. 837



# THE ALL NEW *Slingerland* TEMPO-KING PEDAL • SNAP-ON PEDAL

BOTH PEDALS FEATURE

- THREE ADJUSTABLE STROKE VARIATIONS FOR HARD, MEDIUM AND LIGHT PLAYING
- TWIN BALL BEARING ACTION
- TRULY THE FASTEST MOST DEPENDABLE PEDALS EVER BUILT!

\*To adjust the stroke just remove the slotted, knurled screw above the spring and screw it in the left hole for hard playing, the center hole for medium and the right hole for soft playing.



BOTH PEDALS FOLD COMPACTLY IN ONE PIECE — NO PARTS TO DISASSEMBLE



No. 938  
\$22.00

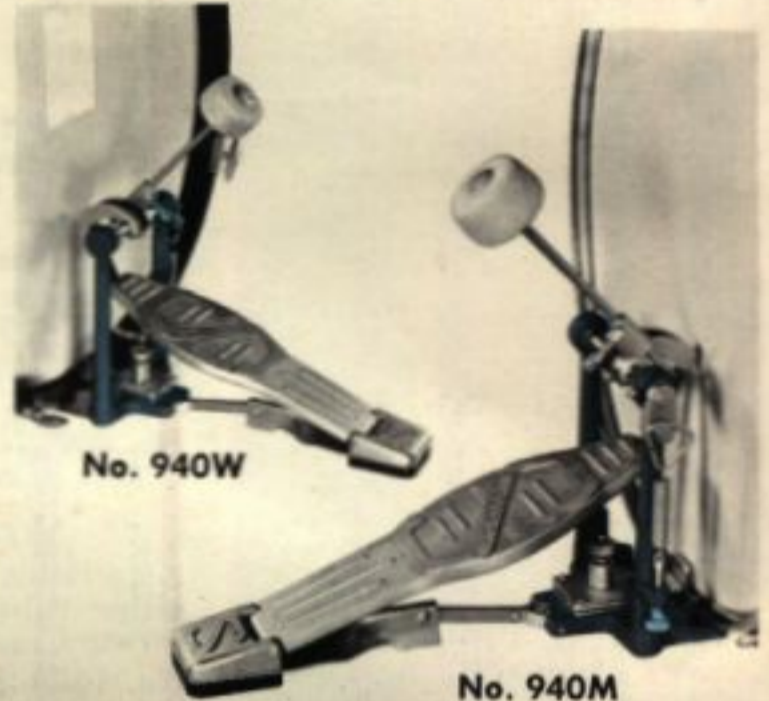

No. 940W

No. 940M

NO. 940W SNAP ON PEDAL FOR WOOD HOOP... \$32.00  
NO. 940M SNAP ON PEDAL FOR METAL HOOP... 32.00



## THE AA PEDAL

A very sturdy, fast pedal, featuring reduced friction by the use of sealed ball bearings; twin springs which ride on hardened round steel studs—almost no friction or wearing at this important point; separate tension adjustment for each spring on either side of the pedal frame;

AA Pedal in Blue Lacquer Finish Complete with Beater .....\$20.00

## THE EPIC PEDAL



No. 939

A smooth, fast, positive action pedal with smooth flowing action. Easily adjusted to the slightest pressure requirements. Durable built of the finest materials, and the price affords the young artist an opportunity to purchase a high-grade pedal at a reasonable price.

No. 939 EPIC Pedal in Red Lacquer.....\$16.00

## *Slingerland* PEDAL BEATERS

A beater for every use. Whether it be soft orchestra work, band work, swing, jazz or whatever style band you might be playing in.

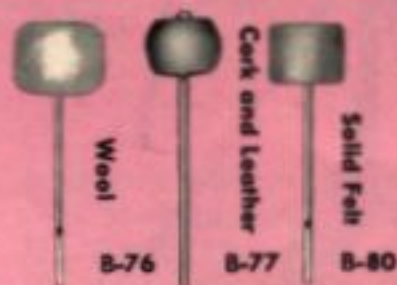

No. B-76 Lambs wool ball and rod.....\$2.50  
No. B-77 Cork ball—transparent calf cover, very fast ..... 3.50  
No. B-80 Solid felt ball and rod..... 2.50  
No. B-78 Solid wood ball and rod..... 1.75

# Slingerland

## TUNED COW BELLS

*Cow Bells Only*

- No. 1376—3½" ..... \$1.75
- No. 1377—4½" ..... 2.00
- No. 1378—5" ..... 2.20
- No. 1379—6½" ..... 2.50
- For Chrome add ..... 1.50

## ZILDJIAN COW BELLS

- \*No. 1374 4½" Rough Chrome ..... \$7.00
- \*No. 1375 4½" Polish Chrome ..... 9.00
- \*No. 1380 6" Rough Chrome ..... 8.00
- \*No. 1381 6" Polish Chrome ..... 10.00

## CHINESE WOOD BLOCK

- No. 798—Medium size... \$2.50

## COMBINATION COW BELL AND WOOD BLOCK HOLDER

It holds any standard size Chinese wood block and two or more cowbells. Attaches firmly to hoop.

- No. 1190—Combination Cowbell and Wood Block Holder and 2 Cowbell Clamps, Chrome..... \$3.50

## NEW COMBINATION HOLDER

Holds any standard size wood block and cow bell. Fastens to hoop with "Shur-Grip" clamp.

- No. 1357—Chrome..... \$3.50

## CASTANETS ON HANDLES

- No. 277 One pair Castanets mounted on handle... \$2.25
- No. 577 Two pair Castanets mounted on handle... \$3.25

## HAND CASTANETS

Hand castanets are used in sets; one pair for each hand. They are tied with bright colored silk cord with tassels.

- No. 771—Per set (2 pair) \$2.00

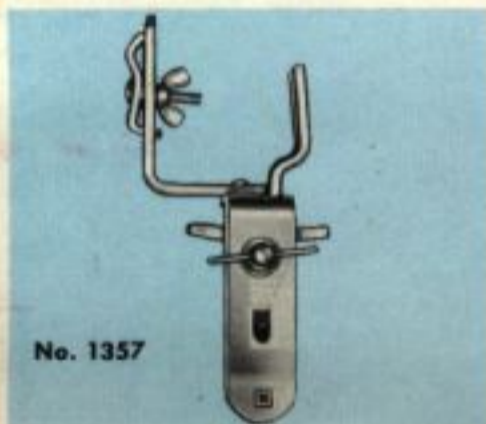

# ACCESSORIES

## COW BELL HOLDER

*Chrome*

- No. 1355—Short, 2¼" ... \$3.00
- No. 1265—Clamps Only extra ..... .30
- No. 1356—7½" ..... 3.20



## NEW SHELL MOUNT COW BELL HOLDER

Designed by Jake Jerger. Folds against shell when not in use.

- No. 1358—Chrome..... \$5.50



## "SHUR-GRIP" DRUM STICK HOLDER

Sticks are securely held and always available when you want them.

- No. 1370—Chrome (except wire) ..... \$3.00



## "STANDARD" PRACTICE PAD

Lacquered solid oak base with rubber pad that simulates closely the feel of a drum head.

- No. 956 ..... \$2.50



## DELUXE PRACTICE PAD

Made of solid oak with a tone chamber that gives you a resonant sound. The rubber pad simulates the feel of a drum head.

- No. 958 ..... \$4.50



## PRACTICE PAD FLOOR STAND

Features a heavy duty, folding base for practice pad mounting. Chrome plated finish. Ideal for studio teaching use and for home and school practice. Pad is sold separately.

- No. 957—Stand only for practice pad, Chrome..... \$8.00



# Features of *Slingerland*

## THE BALL-BEARING CLUTCH

THAT DEFINITELY HOLDS IN ANY POSITION AND WILL NOT SLIP

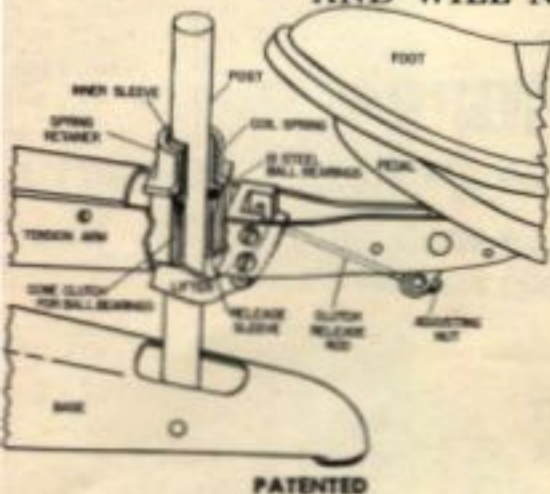

The outstanding feature that places this tympani far in advance of all others is the Silent Ball-Bearing Clutch. Fifteen ball bearings lie in a cone-shaped solid steel housing. These bearings surround the "range post" and create a vice-like grip. This precision (patented) mechanism holds positive in any position. The holding positions are as flexible as a finger on a fiddle string—a hair's breadth movement does it.

## POWER GRASP TUNING HANDLES



Symphonic experts have pronounced this feature highly important. Handles are large and full, form fit to hands for easy grasping, and provide quick, easy, hand tuning leverage. The handle is made of solid brass to prevent rusting due to perspiration. The rod is made of alloy steel—all parts are beautifully chrome plated.

## ONE-SCREW SET UP



Just slacken the tension on the head, raise the pedal and engage the center pull rod with the wing handle. As simple as all that. One screw at base of kettle assembles the bowl and base mechanism. Set up or detached in a few moments—it's the quickest and easiest set-up ever designed.

## EASY TO GET—COMPLETE RANGE

The range, easily obtained on the various size kettles is as follows:—

- 23", from D to A
- 25", from B flat to G
- 28", from F to D
- 26", from A to F
- 29", from E to B
- 30", from E flat to B flat

The positive action ball bearing Clutch pedal adjustment holds to all intermediate tones, and there is no "back-up" on the top notes like on some competitive makes.



# PEDAL TYMPANI

## THE IMPORTANT "BUMP" ON THE KETTLE BRACKET



When the pedal is up as far as it will go (only 8"), the bell-cranks come to a stop at the "bump" built into the kettle bracket. This stop al-

lows no strain on the inside rods when they are in this position. Therefore, when the player turns the handles to "iron out" the head tone to the lowest note, the strain is applied to the brackets and does not disturb the rods. All six inside tension rods are under EQUAL strain when the pedal starts to travel downward to create the various tones on up the scale and enables the player to KEEP even tension over the entire head surface at all times. This is a big factor in preventing that "pulled-down-on-one-side" condition seen on so many tympani which seriously interferes with true tone and tuning ease. The "bump" on the kettle brackets is a patented feature.

## PLAYING CLEARANCE HANDLE



This is another feature exclusively on Slingerland tympani. The handle nearest beating spot is hinged to flip clear when playing. Thus it IS OUT OF THE WAY, and eliminates the accidental knock of beaters against the handle in rapid passages or where passing rolls are being played. This clearance handle tunes and adjusts like the fixed handles yet clears in an instant.

## NEW TILTING MECHANISM



The Slingerland Tympani-Tilting Mechanism\* is designed so that the tympanist can tilt his tympani to the most comfortable and easiest playing angle. This new mechanism is especially useful when the tympanist is seated, which he should be, while making the rapid pedal changes required in modern compositions.

## DEEPER PARABOLIC BOWLS



The true parabolic design produces focused reflection of sound waves for tonal response. This feature of added depth and parabola is found only on Slingerland. Bowls are of genuine copper, one piece, seamless type, or fibreglass.

## ONE-PIECE INSIDE REINFORCEMENT RING



This strong, sturdy alloy steel inside reinforcement ring is standard on all Slingerland tympani with either copper or fibreglass bowls. Its sturdiness gives you even tuning and a clear resonant tone.

**THE REVOLUTIONARY NEW**

*Rhapsody*

**PEDAL TIMPANI**

**with FIBRE-GLASS BOWLS**



**WITH THE PATENTED BALL BEARING CLUTCH THAT HOLDS IN ANY POSITION  
AND DEFINITELY WILL NOT SLIP!**

**SUPPLIED WITH PLASTIC HEADS UNLESS OTHERWISE SPECIFIED**

**NOTE—THE NEW TILTING MECHANISM**

The Rhapsody Timpani are another Slingerland First. They sound great, look great, weigh less and cost less. The new Fibre-glass Bowls, with non-scratching, simulated copper finish, are strong, sturdy and resist denting. The only Fibre-glass Timpani with a hard Gel-coat Finish!

**\*NO. 350 Rhapsody PEDAL TIMPANI**

**\$440<sup>00</sup>**

25" and 28" or 26" and 29" (Specify which) Pedal Timpani, per Pair with Chrome Plated Hardware, Fibre-glass Bowls, Brake Wheels, Head Protectors, Beaters and No. 1204 Instruction Book

*Excise Tax Extra \$24.20*

**RHAPSODY MODEL—ADDITIONAL SIZES**

**\*No. 35023—23" FIBRE-GLASS TIMPANI  
WITH BRAKE WHEELS AND FIBRE HEAD  
PROTECTOR .....\$225.00**  
*Excise tax extra. ....\$12.50*

**\*No. 35030—30" FIBRE-GLASS TIMPANI  
WITH BRAKE WHEELS AND FIBRE HEAD  
PROTECTOR .....\$280.00**  
*Excise tax extra. ....\$15.20*

**THE SENSATIONALLY NEW\***

# Philharmonic Grand

**PEDAL TIMPANI**



**\*WITH THE PATENTED BALL BEARING CLUTCH THAT HOLDS IN ANY POSITION**

**SUPPLIED WITH PLASTIC HEADS UNLESS OTHERWISE SPECIFIED**

The Philharmonic Grand Pedal timpani, like other Slingerland timpani, produce a tone that is unequalled in any other make. The patented silent ball-bearing clutch mechanism is accepted as the finest by timpanists throughout the country—the pedal has no spring which requires constant readjustment. Instead, just tip the footboard forward to release the clutch, tip it back and the clutch holds at any note.

**NOTE—THE NEW TILTING MECHANISM**

**STANDARD MODEL**

Standard Philharmonic Pedal Timpani, copper bowls, satin finish with fibre head protectors, pair of timpani sticks. All metal fittings are beautifully chrome plated.

*Excise Tax*

Specify 25" and 28" or 26" and 29"

\*No. 400W Per pair, with brake wheels... \$485.00 \$28.50\*

*\*Tax Extra*

**DELUXE MODEL**

DeLuxe Philharmonic Pedal Timpani, with polished and buffed copper bowls, and chrome plated metal fittings, with pair timpani sticks, fibre head protectors.

*Excise Tax*

Specify 25" and 26" or 26" and 29"

\*No. 401W Per pair, with brake wheels... \$515.00 \$29.00\*

*\*Tax Extra*

**STANDARD MODEL—ADDITIONAL SIZES**

*Excise Tax*

\*No. 400W-23 23" with brake wheels... \$245.00 \$14.00\*

\*No. 400W-30 30" with brake wheels... 300.00 17.00\*

*\*Tax Extra*

**DELUXE MODEL—ADDITIONAL SIZES**

*Excise Tax*

\*No. 401W-23 23" with brake wheels... \$260.00 \$15.00\*

\*No. 401W-30 30" with brake wheels... 315.00 18.40\*

*\*Tax Extra*

- No. 463 Mackintosh covers, 16" skirt, 25" & 28", pr.. \$18.50
- No. 6931 Mackintosh covers, 28" skirt, 25" & 28", pr.. 24.00
- No. 464 Trunks for Philharmonic Grand Timpani, per pair ..... Net 250.00

**THE** Supreme\*

# PEDAL TIMPANI



\*FORMERLY THE OLYMPIC

**SUPPLIED WITH PLASTIC HEADS UNLESS OTHERWISE SPECIFIED  
NOTE—THE NEW TILTING MECHANISM**

The SUPREME Timpani with its new pedal action and clutch is, without question, the finest timpani ever made. When the pedal is set at a definite pitch—the note remains constant—absolutely no deviation in intonation—the clutch cannot slip. There should be no maintenance costs, just your original purchase price.

The kettles are polished, buffed and clear lacquered. The hoops, tension rods and suspension rods are beautifully chrome plated. Large roller wheels, with brakes, are standard equipment.

- \*No. 402 SUPREME TIMPANI, pair 25" and 28" or 26" and 29" specify which.....  
\$590.00 plus \$34.40 Excise tax  
(Timpani Beaters, No. 1204 Instruction Book and Fibre Head Protectors included.)
- \*No. 40223 23" Supreme Timpani, each.....\$320.00 plus \$18.70 Excise Tax
- \*No. 40230 30" Supreme Timpani each.....350.00 plus 19.50 Excise Tax
- No. 466 Long Skirt Mackintosh Covers to fit, per pair.....\$ 32.00
- No. 403 Trunks for SUPREME Timpani, pair, net.....325.00 NET  
(Also available with FIBRE-GLASS Bowls)
- \*No. 402FB 25" and 28" or 26" and 29" Fibre-glass Timpani, specify which, per pair.....  
\$520.00 plus \$29.60 Excise Tax
- \*No. 40223FB 23" Fibreglass Timpani, each.....290.00 plus 15.80 Excise Tax
- \*No. 40230FB 30" Fibreglass Timpani, each.....320.00 plus 17.60 Excise Tax



No. 1204 Slingerland Timpani Instruction Manual...\$2.00  
By Haskell Harr. A modern, up-to-date, timpani method.  
Starts very elementary. Contains 72 pages of graduated studies, well illustrated. Much emphasis on tuning.

**SLINGERLAND—THE FOREMOST IN TIMPANI**

# DRUMS AND EQUIPMENT FOR A.A.O.N.M.S. SHRINE ORIENTAL AND MARCHING BANDS



**CONGO**  
No. 280 ..... \$60.00  
No. 281 ..... 70.00



**TENOR TYMP**  
No. 1700 12"x18" Lacquer \$98.00  
Add \$14.00 for Pearl



**TENOR-SCOTCH**  
No. 603 6 1/2"x18" Lacquer \$90.00  
Add \$14.00 for Pearl



**SCOTCH DRUM**  
No. 605 10"x26" Lacquer \$107.00  
Add \$20.00 for Pearl



**VERTICAL TENOR**  
No. 703 WT 12"x16" Lac. \$75.50  
No. 708 WT 12"x16" Pearl 91.00  
No. 816 Holder extra..... 20.00



**SUPER-TENSION  
PARADE DRUM**  
No. 502F 12"x15" Lacq'r \$94.00  
No. 506F 12"x15" Pearl 106.00



**TOURNAMENT MODEL  
PARADE DRUM**  
No. 700W 10"x15" Lacq'r \$67.50  
No. 705W 10"x15" Pearl 80.50



**TOURNAMENT MODEL  
TENOR DRUM**  
No. 703FT 12"x16" Lacq'r \$81.00  
No. 708FT 12"x16" Pearl 96.50



**ZILDJIAN GONG**  
\*No. G-918 18" ..... \$50.00  
No. 694 Gong Mallet. .... 2.50



**TRIANGLE & BEATER**  
No. 786 10" ..... \$2.95  
No. 793 Suspender..... .20



**SOPRANO MUSETTE**  
Key of F, rosewood body, over-  
size mouthpiece, chrome bell, true  
Arabian tone quality  
\*No. 1710 ..... \$82.50  
\*No. 1130 Case..... 13.00



**TAMBORINE**  
No. RT-10 10" 9 jingles.. \$7.50  
No. RT-17 10" 17 jingles.. 9.75



**SIGNAL BATON**  
No. 1029 ..... \$22.00

# Slingerland

## CONCERT TOM TOM OUTFIT No. 3C

### Outfit Includes

|                      |                                  |       |                 |
|----------------------|----------------------------------|-------|-----------------|
| No. 1440             | 8"x12" Timb-Tom                  | ..... | \$ 47.00        |
| No. 1441             | 9"x13" Timb-Tom                  | ..... | 49.00           |
| No. 1442             | 12"x14" Timb-Tom                 | ....  | 72.00           |
| No. 802              | Flush Base Stands (3)            | ...   | 38.40           |
| No. 788              | Felt Mallets, Pair               | ..... | 2.50            |
| No. 724              | Hard Yarn Wound<br>Mallets, Pair | ..... | 3.75            |
| Total Value in Pearl |                                  |       | <b>\$212.65</b> |

### SPECIAL PRICES

|         |                               |                                                       |
|---------|-------------------------------|-------------------------------------------------------|
| No. 3C  | Choice of Pearl<br>Finishes   | \$198.00                                              |
| No. 3CL | Choice of Lacquer<br>Finishes | 173.00                                                |
|         |                               | Excise Tax Extra<br>(No. 838 Throne<br>Extra \$20.00) |



# Slingerland

## WIRE JAZZ BRUSHES

### THE CHOICE OF PROFESSIONALS

Slingerland brushes are made of plated, bright tempered music wire. The wires will not come out. The tubular handles are made of tempered aluminum tubing on the rubber handle models, and brass tubing, nickel plated is used on models No. 730L and No. 731B

Each brush is perfectly balanced.

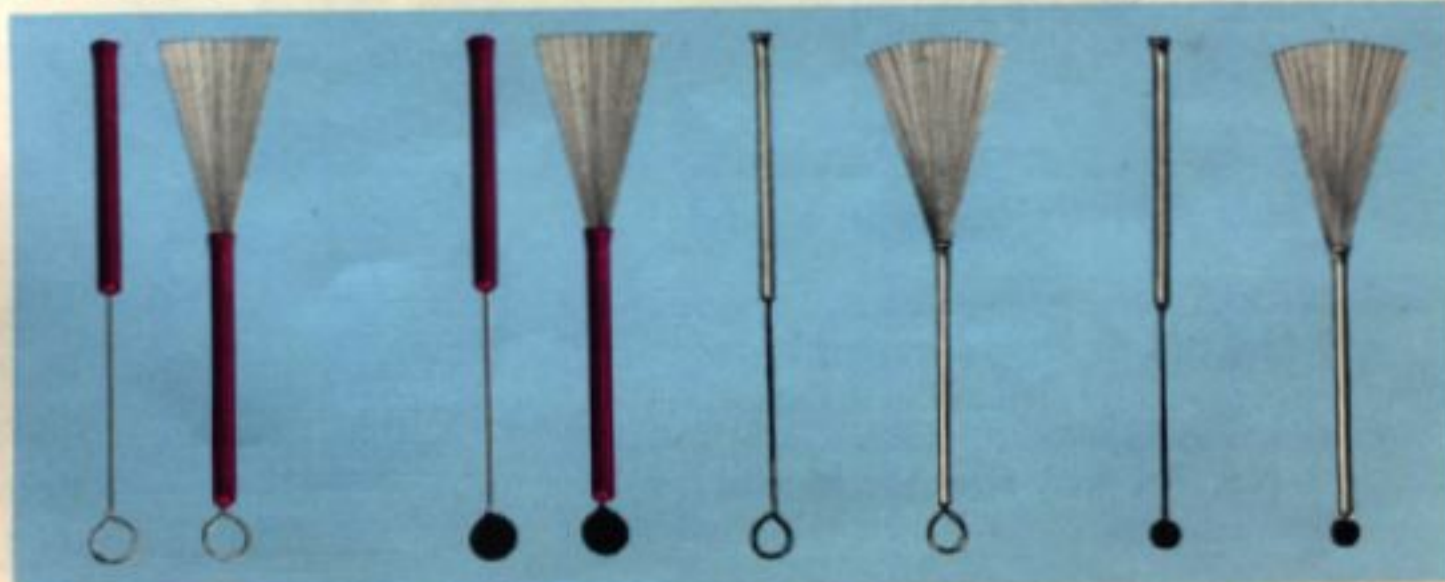

**No. 728GK**  
pair.....\$ 1.75  
Krupa model  
Ribbed, red  
rubber handle,  
loop end.

**No. 729B**  
pair.....\$ 1.80  
Ribbed, red  
rubber handle,  
black rubber  
ball end.

**No. 730L**  
pair.....\$ 1.55  
Nickel plated  
handle, loop  
ends.

**No. 731B**  
pair.....\$ 1.60  
Nickel plated  
handle, black  
rubber ball end.



# Slingerland STICKS

SILICONE TREATED—HELPS PREVENT WARPAGE DUE TO MOISTURE

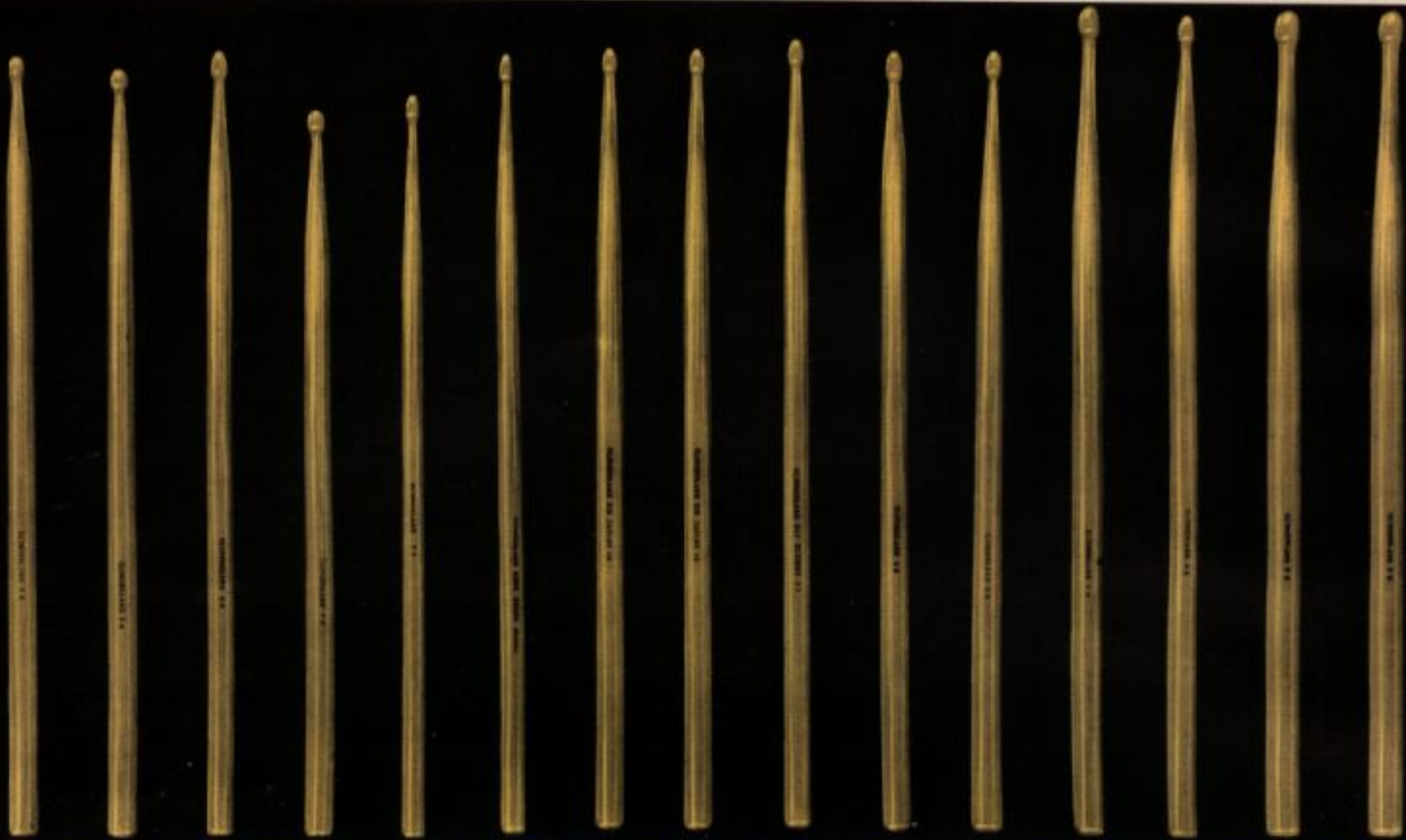

|         |         |         |         |         |         |         |         |     |         |     |         |         |         |         |
|---------|---------|---------|---------|---------|---------|---------|---------|-----|---------|-----|---------|---------|---------|---------|
| 2A      | 3A      | 5A      | 6A      | 7A      | Krupa   | 18A     | 19A     | 21A | 2B      | 5B  | 15      | 25      | 35      | 1H      |
| 15 3/4" | 15 1/2" | 15 7/8" | 14 3/4" | 15 1/8" | 15 7/8" | 15 3/4" | 15 3/4" | 16" | 15 7/8" | 16" | 16 7/8" | 16 7/8" | 16 7/8" | 16 7/8" |

Slingerland Drum Sticks are the finest made. Turned from choice second growth hickory, Silicone treated, machine sanded, filed and hand sanded. Double dipped in clear lacquer, and carefully inspected and matched.

**SILICONE TREATED  
HICKORY DRUM STICKS**  
\$1.20 per pair

"A" denotes dance or orchestra.  
"B" denotes band.  
"S" or "H" denotes street.





**FAMOUS MODELS**

- Krupa**  
 2A Jake Jerger  
 7A Roy Haynes  
 18A Sonny Igoe  
 19A Rufus Jones  
 21A Jake Hanna  
 1H Les Parks  
 2B Haskell Harr

**VIBRAHARP MALLETS**

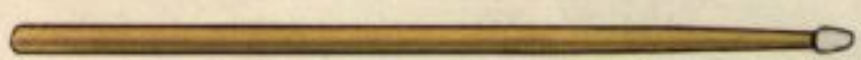
- 
- No. 722 Soft, Yellow Yarn, pair ..... \$3.75  
 No. 723 Medium, Blue Yarn, pair ..... 3.75  
 No. 724 Hard, Purple Yarn, pair ..... 3.75

**NYLON TIP HICKORY DRUM STICKS IN FOUR POPULAR MODELS!**

-  No. GKN Gene Krupa Model
-  No. 5N Bobby Morris Model
-  No. 7N Roy Haynes Model
-  No. 19N Rufus Jones Model



**\$1.95 per pair**

The nylon tip is guaranteed not to pull off and to outlast the hickory stick. The Krupa and Bobby Morris models have a tip designed for a live, brilliant cymbal sound. The Roy Haynes and Rufus Jones models have a smaller tip that gives a less brilliant cymbal sound.

# Slingerland

## BEATERS

### TENOR DRUM STICKS



No. 1660 Solid felt balls (1 3/4" dia.), 13 3/4" long, thongs, pair... \$ 6.00



No. 1661 Solid felt balls (1 3/4" dia.), 10 3/4" long, thongs, pair... \$ 5.50



No. 1665 Solid felt balls (1 3/4" dia.), 10 3/4" long, thongs, pair... \$ 6.00

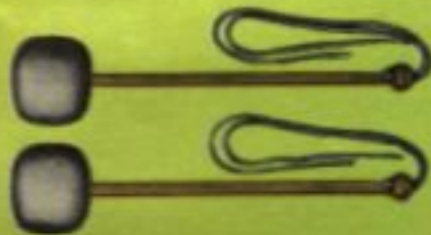

No. 1705 Tenor Tymp lambs wool ball, 11" long, thongs, pair \$ 6.00

### SCOTCH DRUM BEATERS



No. 822 Solid felt balls (2" dia.), 13 3/4" long, thongs, pair... \$ 6.00



No. 823 Solid felt balls (2" dia.), 14" long, thongs, pair... \$ 6.50

### TYMPANI STICKS



No. 717 Sewed piano felt balls (1 6/8" dia.), 14" long, pair... \$ 5.30



No. 718 With sewed piano felt balls (1 3/4" dia.), hard model, pair... \$ 5.00  
Replacement balls, pair... 3.00



No. 719 With sewed piano felt balls, (1 3/4" dia.), medium model pair... \$ 5.30  
Replacement balls, pair... 3.30



No. 720 With sewed piano felt balls (1 3/4" dia.), soft model, pair... \$ 5.80  
Replacement balls, pair... 3.80

### NEW SOLID BEATER

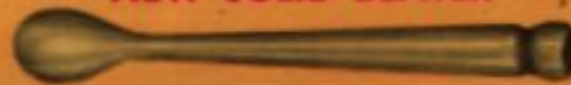

No. 695 For bass or Scotch drum... \$ 2.50

### SPECIALTY STICKS



No. 694 Gong, cymbal sticks, etc., solid felt ball. Each... \$ 2.50



No. 788 Hickory with round end felt balls, pair... \$ 2.50

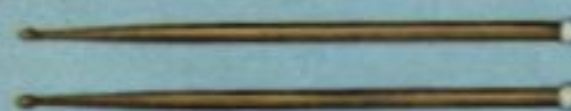

No. 792 Stanley Krell Model. Two-in-One, felt ends, pair... \$ 2.50

### BASS DRUM BEATERS



No. 691 Sousa model. Large, lambs wool ball on each end. 15 3/4" long. Each... \$ 5.50



No. 692 Concert band model, lambs wool ball on each end, standard model. 15" long, each... \$ 5.50



No. 789 Concert or Corps model, with leather thong hand grip, lambs wool ball. 15 1/2" long, each... \$ 6.25



No. 713 Band model, felt core, wool covered, 13 3/4" long, each \$ 4.70



No. 714 Band or Corps, double end model, solid felt balls, 13 3/4" long, each... \$ 4.20



No. 715 Double lambs wool balls, 14 3/4" long, each... \$ 5.50



No. 716 Single solid felt ball. Band or Corps model, 12 3/4" long, each... \$ 4.00



No. 790 Solid felt ball, lambs wool covered grip and leather thong. 12 3/4" long, each... \$ 6.50



**CHAMPIONSHIP CORPS USE SLINGERLAND! (AMERICAN MADE BUGLES)**

**BUGLE PRICES INCLUDE FEDERAL EXCISE TAX**

**COMPLETELY NEW SLINGERLAND ROTARY VALVE SLIDES**

**G-D Soprano Piston Bugle** — Carries the melody. Constructed in key of G with valve change to D and slide to F.  
 20 Inches Long, 25 Ounces, 5" Bell  
 1600 Brass Lacquered, Highly Polished .....\$72.50  
 1604 Chromium ..... 85.00

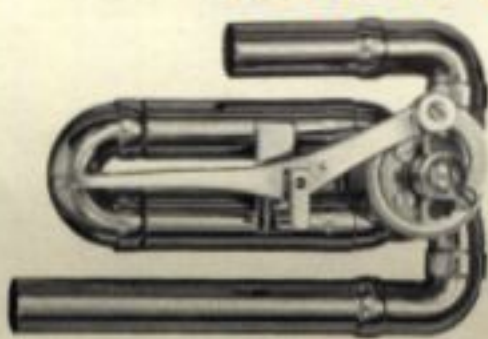

**NEW SOPRANO ROTARY SLIDE**



**NEW BASS-BARITONE ROTARY SLIDE**

**G-D Baritone Piston Bugle** — A beautiful model, pitched one octave lower than the soprano, that is easy to blow, rich in tone and true pitch. Tuning slide and special mouthpiece.  
 24½ Inches Long, 42 Ounces, 6½" Bell  
 1620 Brass Lacquered .....\$110.00  
 1624 Chromium ..... 127.50

The new series F and F $\sharp$  rotary slides are available for all models. These new rotary valve slides are of the highest calibre. The new design and workmanship are key features of these new superior rotary valve slides. The rotary valves are designed and built for a long and dependable life, with bearing surfaces that distribute the friction load over a wide surface with less wear. The valve is fitted with unusual precision for smooth action. The fast acting horizontal valve lever is easily accessible and will allow even trills to be played! This skillful design permits an exceptionally short stroke for faster action and cleaner execution. A truly great achievement in rotary valve design, skillfully engineered with new bores which allow acoustical properties that improve both the tonal response and the tuning of each bugle.

**New Slingerland French Horn Piston Bugles** — Increases range and tonal depth of your bugle section. Valve change from G to D.  
 25 Inches Long, 48 Ounces, 8" Bell  
 1626 Brass Lacquered, High Polish .....\$145.00  
 1659 Chromium ..... 175.00

**PRICES—ROTARY VALVE SLIDES FOR SLINGERLAND BUGLES**

|       |                                                           | Brass Lacquered | Chrome  |
|-------|-----------------------------------------------------------|-----------------|---------|
| SR-4  | Soprano F $\sharp$ Rotary Slide.....                      | \$36.00         | \$39.00 |
| SR-10 | Soprano F Rotary Slide.....                               | 36.00           | 39.00   |
| SR-16 | Baritone, French Horn, Bass, F $\sharp$ Rotary Slide..... | 37.50           | 40.00   |
| SR-18 | Baritone, French Horn, Bass, F Rotary Slide.....          | 37.50           | 40.00   |

*Tax Included*

**New Slingerland Bass Piston Bugles** —  
 24 Inches Long, 64 Ounces, 10" Bell  
 1701 Brass Lacquered, Highly Polished .....\$173.00  
 1702 Chromium ..... 225.00

**BUGLE MOUTHPIECES**

Properly adapted and tested mouthpieces that are correctly shaped. These are the types that are regularly supplied on all Slingerland bugles.  
 No. 1139 Soprano and Tenor....\$3.00  
 No. 1141 Baritone ..... 4.00  
 No. 1142 French Horn ..... 4.00  
 No. 1143 Bass ..... 6.50

**G BUGLE**

This is the finest type of bugle made. It is heavily constructed, has excellent blowing qualities, and the intonation is true-throughout. Bugle is pitched in "G" with slide to "F." Length is 17".  
 No. 1055 Only .....\$12.40

No. 1055



**BUGLE CASES**

Good bugles deserve protection. Hard shell, long wear plush lined. Pyroxylin coated Alligator covering.  
 \*1131 Soprano case .....\$13.00  
 \*1135 Baritone case ..... 18.00  
 \*1136 French Horn case..... 21.00  
 \*1137 Bass Bugle case..... 26.30

# The nation's finest use Slingerland!



UNIVERSITY OF WISCONSIN, RAY DVORAK, DIRECTOR



UNIVERSITY OF MINNESOTA, DR. FRANK BENCRISLUTO, DIRECTOR



UNIVERSITY OF MICHIGAN, WM. D. REVELL, DIRECTOR



CORNELL UNIVERSITY, WILLIAM A. CAMPBELL, DIRECTOR



ITHACA COLLEGE PERCUSSION ENSEMBLE, WARREN BENSON, CONDUCTOR



MICHIGAN STATE UNIVERSITY, LEONARD FALCONE, DIRECTOR

# New

## SUPER TENSION

### Parade Drums

WITH THE NEW ZOOMATIC SNARE STRAINER AND RIM-SHOT COUNTER HOOPS THAT SAVE YOUR UNIFORMS



NO. 513 10" x 28"



NO. 506F 12" x 15"



NO. 506FT 12" x 15"

ILLUSTRATED FINISH—SPARKLING SILVER

## SUPER-TENSION PARADE DRUMS

### 8-TENSION LUGS

(WITH RIM-SHOT METAL HOOPS AND CHROME PLATED HARDWARE)

| No.   | Sticks and Slings Included        | Price<br>Parade<br>Drum | Price<br>Matching<br>Tenor Drum |
|-------|-----------------------------------|-------------------------|---------------------------------|
| 500 F | 10"x14" Mahogany or lacquer . . . | \$80.00                 | 500 FT \$ 79.50                 |
| 501 F | 10"x15" Mahogany or lacquer . . . | 82.00                   | 501 FT 81.50                    |
| 502 F | 12"x15" Mahogany or lacquer . . . | 94.00                   | 502 FT 93.50                    |
| 503 F | 12"x16" Mahogany or lacquer . . . | 95.00                   | 503 FT 94.50                    |
| 504 F | 10"x14" Choice of Pearl finishes. | 92.00                   | 504 FT 91.50                    |
| 505 F | 10"x15" Choice of Pearl finishes. | 94.00                   | 505 FT 93.50                    |
| 506 F | 12"x15" Choice of Pearl finishes. | 106.00                  | 506 FT 105.50                   |
| 507 F | 12"x16" Choice of Pearl finishes. | 107.00                  | 507 FT 106.50                   |

Excise Tax Extra

IF DESIRED WITH 10-TENSION RODS ADD \$10.00

SUPPLIED WITH SILK WIRE-WOUND SNARES,

IF GUT OR NYLON SNARES ARE ORDERED ADD \$2.00

## SUPER-TENSION SCOTCH BASS DRUM

CHROME PLATED

| No. | (Sticks and sling included, specify white or khaki) | Price<br>Lacquer or<br>Mahogany | Price<br>Pearl |
|-----|-----------------------------------------------------|---------------------------------|----------------|
| 510 | 8"x26" Sep. tens. center lug—Scotch dr..            | \$112.00                        | \$132.00       |
| 511 | 10"x26" Sep. tens. center lug—Scotch dr..           | 112.00                          | 132.00         |
| 512 | 8"x28" Sep. tens. center lug—Scotch dr..            | 121.00                          | 141.00         |
| 513 | 10"x28" Sep. tens. center lug—Scotch dr..           | 121.00                          | 141.00         |

Excise Tax Extra

Pearl inlaid hoops come with all pearl models.

Pearl inlaid hoops on lacquer model drums, EXTRA \$3.00

New SUPER-TENSION parade drums by Slingerland are the ultimate in parade drum design. Featuring the new SUPER-TENSION lug, ZOOMATIC snare strainer that has the smoothest, easiest action and is the finest strainer ever designed. Tone controls are standard on both parade and tenor drums.

All heads are Slingerland Sound King plastic with built in mufflers.

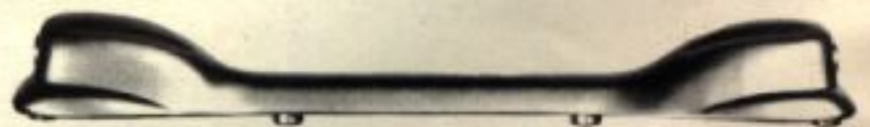

## NEW SUPER-TENSION CASING



*Slingerland*

**SUPER-TENSION  
OUTFIT**

**PARADE DRUM OUTFIT NO. 4P**

The new SUPER TENSION parade drum outfit features drums with the new SUPER TENSION LUG and the new ZOOMATIC snare strainer—the ultimate in parade drum design. All heads are Slingerland Sound King Plastic with built-in muffler straps.

**SPECIAL PRICES**

**COMPLETE SUPER TENSION  
PARADE DRUM OUTFIT**

| <i>Outfit Includes</i>               |                                                                 | <i>Price<br/>Pearl &amp;<br/>Chrome</i> |
|--------------------------------------|-----------------------------------------------------------------|-----------------------------------------|
| 3                                    | <b>No. 506F</b> 12"x15" Super Tension<br>Parade Drums .....     | <b>\$318.00</b>                         |
| 3                                    | <b>No. 506FT</b> 12"x15" Super Tension<br>Tenor Drums .....     | <b>316.50</b>                           |
| 2                                    | <b>No. 513</b> 10"x28" Super Tension<br>Scotch Bass Drums ..... | <b>282.00</b>                           |
| 6                                    | <b>No. 1727</b> LEG RESTS ATTACHED .....                        | <b>40.80</b>                            |
| Total value in Pearl and Chrome..... |                                                                 | <b>\$957.30</b>                         |
| Sticks and Slings included           |                                                                 |                                         |
| <i>Excise Tax Extra</i>              |                                                                 |                                         |

| <i>Chrome</i>                                                                                                  |                 |
|----------------------------------------------------------------------------------------------------------------|-----------------|
| <b>No. 4P</b> Choice of Pearl Finishes.....                                                                    | <b>\$910.00</b> |
| <b>No. 4PL</b> Choice of Lacquer Finishes.....                                                                 | <b>800.00</b>   |
| Sticks and Slings included for all drums                                                                       |                 |
| Gut or Nylon Snares on three drums, add....                                                                    | <b>\$6.00</b>   |
| Prices shown are for 8 lugs on parade and tenor drums.<br>If 10 lugs are desired, add \$55.00 to outfit price. |                 |
| <i>Excise Tax Extra</i>                                                                                        |                 |
| * EIGHT FIBRE CASES FOR ABOVE.....                                                                             | <b>\$160.00</b> |
| (Total Value ..... <b>\$171.40</b> )                                                                           |                 |
| EIGHT MACKINTOSH ZIPPER COVERS                                                                                 |                 |
| FOR ABOVE .....                                                                                                | <b>\$ 68.00</b> |
| (Total Value ..... <b>\$ 75.20</b> )                                                                           |                 |

# Slingerland

"HASKELL W. HARR MODEL"

## Parade Drums

WITH THE NEW ZOOMATIC SNARE STRAINER AND RIM-SHOT COUNTERHOOPS THAT SAVE YOUR UNIFORMS!



NO. 613 10" x 28"



NO. 660F 12" x 15"

NO. 660FT 12" x 15"

ILLUSTRATED FINISH—SPARKLING SILVER WITH SPARKLING GREEN CENTER

### HASKELL W. HARR MODEL PARADE AND TENOR DRUMS SEPARATE TENSION—ZOOMATIC STRAINER— —TWIN STREAMLINED LUGS

(WITH RIM-SHOT METAL HOOPS AND CHROME PLATED HARDWARE)

| Sticks and Sling Included    |                               | Price<br>Parade<br>Drum | Price<br>Matching<br>Tenor Drum |
|------------------------------|-------------------------------|-------------------------|---------------------------------|
| No. 536F                     | 10"x14" Lacquer or mahog.     | \$73.00                 | 536FT \$72.50                   |
| No. 521F                     | 10"x15" Lacquer or mahog.     | 75.50                   | 521FT 75.00                     |
| No. 522F                     | 12"x15" Lacquer or mahog.     | 83.00                   | 522FT 82.50                     |
| No. 524F                     | 12"x16" Lacquer or mahog.     | 84.50                   | 524FT 84.00                     |
| No. 658F                     | 10"x14" Choice Pearl finishes | 85.00                   | 658FT 84.50                     |
| No. 659F                     | 10"x15" Choice Pearl finishes | 90.00                   | 659FT 89.50                     |
| No. 660F                     | 12"x15" Choice Pearl finishes | 98.00                   | 660FT 97.50                     |
| No. 662F                     | 12"x16" Choice Pearl finishes | 99.00                   | 662FT 98.50                     |
| Gut or Nylon Snares, EXTRA.. |                               | 2.00                    |                                 |

Excise Tax Extra

### HASKELL W. HARR MODEL SCOTCH BASS DRUMS SEPARATE TENSION—TWIN STREAMLINED LUGS CHROME PLATED

| (Sticks and Sling included, specify white or khaki) |                                        | Price<br>Lacquer or<br>Mahogany | Price<br>Pearl |
|-----------------------------------------------------|----------------------------------------|---------------------------------|----------------|
| No. 610                                             | 8"x26" Sep. tens. twin lug Scotch dr.  | \$112.00                        | \$132.00       |
| No. 611                                             | 10"x26" Sep. tens. twin lug Scotch dr. | 112.00                          | 132.00         |
| No. 612                                             | 8"x28" Sep. tens. twin lug Scotch dr.  | 121.00                          | 141.00         |
| No. 613                                             | 10"x28" Sep. tens. twin lug Scotch dr. | 121.00                          | 141.00         |

Excise Tax Extra

PEARL INLAID HOOPS COME WITH ALL PEARL MODELS  
PEARL INLAID HOOPS ON LACQUER MODEL DRUMS, EXTRA \$3.00

Slingerland "Haskell W. Harr" parade drums are the most popular drums on the market. Their sound, beauty, and precision construction are the finest. They contain 30% more non-ferrous (non-rusting) metal than most other makes. The precision built rim-shot counterhoops are 50% stronger than others—resulting in more even tensioning and better sound.

Supplied with the new Zoomatic snare strainer—the smoothest, fastest acting and most sturdy snare strainer ever designed. Tone controls are standard on both parade and tenor drums. The shells are molded 3 ply with solid maple inside reinforcing hoops.

Supplied with "Weather-All" plastic heads unless calf heads are specified.

Supplied in whatever lacquer finish you desire—highly polished or in choice of pearl finishes—see back cover.

*Slingerland*

**HASKELL W. HARR  
OUTFIT**



**PARADE DRUM OUTFIT No. 5P**

**SPECIAL PRICES  
COMPLETE HASKELL W. HARR  
PARADE DRUM OUTFIT**

| <i>Outfit Includes</i> |                                              | <i>Price<br/>Pearl &amp;<br/>Chrome</i> |
|------------------------|----------------------------------------------|-----------------------------------------|
| 3                      | No. 660F 12"x15" Harr Parade Drums . . . . . | \$294.00                                |
| 3                      | No. 660FT 12"x15" Harr Tenor Drums . . . . . | 292.50                                  |
| 2                      | No. 613 10"x28" Harr Scotch Drums . . . . .  | 282.00                                  |
| 6                      | No. 1727 Chrome Leg Rests Attached . . . . . | 40.80                                   |

Total Value in Pearl & Chrome . . . . . \$909.30  
Sticks and Slings Included

*Excise Tax Extra*

|                                                  | <i>Chrome</i>           |
|--------------------------------------------------|-------------------------|
| No. 5P Choice of Pearl Finishes . . . . .        | \$864.00                |
| No. 5PL Choice of Lacquer Finishes . . . . .     | 740.00                  |
| Sticks and Slings included for all drums         |                         |
| Gut or Nylon Snares on three drums, add. . . . . | \$6.00                  |
|                                                  | <i>Excise Tax Extra</i> |

\* EIGHT FIBRE CASES FOR ABOVE . . . . . \$160.00  
(Total Value . . . . . \$171.40)

EIGHT MACKINTOSH ZIPPER COVERS  
FOR ABOVE . . . . . \$ 68.00  
(Total Value . . . . . \$ 75.20)



# Slingerland

## "PARADE KING" MODEL

### Parade Drums

WITH THE NEW ZOOMATIC SNARE STRAINER  
AND RIM-SHOT COUNTER HOOPS  
THAT SAVE YOUR UNIFORMS!



NO. 706F 12" x 15"



NO. 706FT 12" x 15"



NO. 608 10" x 28"

ILLUSTRATED FINISH—SPARKLING RED PEARL

### PARADE KING

#### PARADE AND TENOR DRUMS

ZOOMATIC SNARE STRAINER—SEPARATE  
TENSION—STREAMLINED CENTER LUG

(WITH RIM-SHOT METAL HOOPS AND CHROME PLATED HARDWARE)

Sticks and Slings Included

|      |         |                                | Price<br>Parade<br>Drum | Price<br>Matching<br>Tenor Drum |
|------|---------|--------------------------------|-------------------------|---------------------------------|
| 699F | 10"x14" | Mahogany or lacquer . . .      | \$69.00                 | 699FT \$68.50                   |
| 700F | 10"x15" | Mahogany or lacquer . . .      | 73.00                   | 700FT 72.50                     |
| 701F | 12"x15" | Mahogany or lacquer . . .      | 79.00                   | 701FT 78.50                     |
| 703F | 12"x16" | Mahogany or lacquer . . .      | 81.50                   | 703FT 81.00                     |
| 704F | 10"x14" | Choice of Pearl finishes . . . | 81.00                   | 704FT 80.50                     |
| 705F | 10"x15" | Choice of Pearl finishes . . . | 86.00                   | 705FT 85.50                     |
| 706F | 12"x15" | Choice of Pearl finishes . . . | 94.00                   | 706FT 93.50                     |
| 708F | 12"x16" | Choice of Pearl finishes . . . | 97.00                   | 708FT 96.50                     |

Gut or Nylon Snares, EXTRA.. 2.00

Excise Tax Extra

### PARADE KING

#### SCOTCH BASS DRUMS

SEPARATE TENSION—STREAMLINED CENTER LUG

Chrome Plated

(Sticks and sling included, specify white or khaki)

|     |         |                                  | Price<br>Lacquer or<br>Mahogany | Price<br>Pearl |
|-----|---------|----------------------------------|---------------------------------|----------------|
| 606 | 8"x26"  | Sep. tens. center lug—Scotch dr. | \$107.00                        | \$127.00       |
| 605 | 10"x26" | Sep. tens. center lug—Scotch dr. | 107.00                          | 127.00         |
| 607 | 8"x28"  | Sep. tens. center lug—Scotch dr. | 116.00                          | 136.00         |
| 608 | 10"x28" | Sep. tens. center lug—Scotch dr. | 116.00                          | 136.00         |

Excise Tax Extra

Pearl Inlaid Hoops Come with All Pearl Models

Pearl Inlaid Hoops on Lacquer Model Drums, Extra \$3.00

The Parade King Model Parade Drums are the same as those used by the Hawthorne Caballeros—American Legion National Champions for the past four years. The new Zoomatic snare strainer puts these models far ahead of any other make. The patented Rim-Shot counterhoops save wear and tear on your uniforms. The shells are molded 3-ply laminated veneers with solid maple inside reinforcing hoops. Supplied with Sound King plastic heads unless calf heads are specified. Tone controls are standard equipment on both parade and tenor drums.



NO. 1726 ROD MOUNT  
LEG REST, CHROME.....\$6.80



NO. 1727 SHELL MOUNT  
LEG REST, CHROME.....\$6.80

*Slingerland*

**PARADE KING  
OUTFIT**



**PARADE DRUM OUTFIT NO. 6P**

**SPECIAL PRICES  
COMPLETE PARADE KING  
PARADE DRUM OUTFIT**

| <i>Outfit Includes</i>               |                                                        | <i>Price<br/>Pearl &amp;<br/>Chrome</i> |
|--------------------------------------|--------------------------------------------------------|-----------------------------------------|
| 3                                    | No. 706F 12"x15" Parade King<br>Parade Drums .....     | \$282.00                                |
| 3                                    | No. 706FT 12"x15" Parade King<br>Tenor Drums .....     | 280.50                                  |
| 2                                    | No. 608 10"x28" Parade King<br>Scotch Bass Drums ..... | 272.00                                  |
| 6                                    | No. 1727 Chrome LEG RESTS Attached ..                  | 40.80                                   |
| Total Value in Pearl and Chrome..... |                                                        | \$875.30                                |
| Sticks and Slings included           |                                                        |                                         |

*Excise Tax Extra*

|                                         | <i>Chrome</i> |
|-----------------------------------------|---------------|
| No. 6P Choice of Pearl Finishes.....    | \$830.00      |
| No. 6PL Choice of Lacquer Finishes..... | 705.00        |

Sticks and Slings included for all drums  
Gut or Nylon Snares on three drums, add... \$6.00  
*Excise Tax Extra*

\*EIGHT FIBRE CASES FOR ABOVE.....\$160.00  
(Total Value .....\$171.40)

EIGHT MACKINTOSH ZIPPER COVERS  
FOR ABOVE .....\$ 68.00  
(Total Value .....\$ 75.20)



# New THIN\* Twirling

## SCOTCH DRUMS

by *Slingerland*

**A NEW ADDED FLASH FOR YOUR MARCHING BAND!**

The new *THIN* twirling Scotch Drums add tremendous flash and color to your marching band. The twirling rig is easily removable for handling and storage purposes. The sound and carrying power of these new drums is very close to a regular Scotch Bass Drum. The twirling rig is designed so that the drum may be locked in a vertical position or it may be spun on a frictionless ball bearing. The hardware on the drum is triple chrome plated.

|         | <i>Sticks Included</i>                       | <i>Price<br/>Lacquer or<br/>Mahogany</i> | <i>Price<br/>Pearl</i> |
|---------|----------------------------------------------|------------------------------------------|------------------------|
| No. 614 | 6" x 26" thin Scotch drum, with twirler..... | \$166.00                                 | \$186.00               |
| No. 615 | 6" x 28" thin Scotch drum, with twirler..... | 175.00                                   | 195.00                 |

*Excise Tax Extra on  
Scotch Drum only*

\*WITH TWO HEADS

## *Slingerland* TENOR TYMP

The modern drum corps or school band is not considered a complete unit today unless it includes our tenor drums or tenor tymps. The flash of a well synchronized tenor drum section is the finest selling point that a corps or band can have. It gives the unit a profound distinction from a showmanship viewpoint that cannot be obtained in any other way. The flash, however, is strengthened by the use of our tenor tymps with chrome plated reflectors. THE TYMPANI LIKE TONE IS SUPERB. Supplied with plastic heads unless calf is requested.

**TENOR TYMP**  
*Chrome Plated*

*No. 1727 Leg Rest, Beaters and Sling are included in the price*

|          |           |                                                      |         |
|----------|-----------|------------------------------------------------------|---------|
| No. 1710 | 10" x 14" | Choice of Lacquer Finishes or Mahogany..             | \$82.00 |
| No. 1711 | 12" x 15" | Choice of Lacquer Finishes or Mahogany..             | 83.50   |
| No. 1712 | 12" x 16" | Choice of Lacquer Finishes or Mahogany..             | 86.00   |
| No. 1700 | 12" x 18" | Choice of Lacquer Finishes or Mahogany..             | 98.00   |
|          |           | Choice of Pearl Finishes with Inlaid Hoops.....Extra | 14.00   |
|          |           | Rim Shot Metal Hoop.....Extra                        | 2.50    |

*Excise Tax Extra*

No. 1712—TENOR TYMP



ILLUSTRATED FINISH—SPARKLING GREEN PEARL

## NEW! SCOTCH DRUM TWIRLER



This new Scotch Drum Twirling Rig is fast gaining popularity. Made of aluminum alloy it weighs only 4 lbs., but is very strong. Swivel turns on a sealed ball bearing. A flip of the finger, locks the drum in a vertical position.

No. 817 Scotch Twirler.....\$59.95

## NEW! HASKELL W. HARR MODEL "TENOR-SCOTCH" DRUM

This new "Tenor-Scotch" Drum adds great flash and a new sound to your percussion section. With this thinner drum, the player can easily reach over the shell to play on the opposite head. This permits use of the same routine beats being used on both Tenor and Scotch drums.

Chrome plated, sticks and sling included.



|         |                                                                           |                                |              |
|---------|---------------------------------------------------------------------------|--------------------------------|--------------|
| No. 603 | 6½"x18". Separate Tension<br>With Triple-Flanged "Rim-Shot"<br>Hoops..... | <i>Lacquer or<br/>Mahogany</i> | <i>Pearl</i> |
|         |                                                                           | \$90.00                        | \$104.00     |
|         |                                                                           | ADD                            | 4.00         |

*Excise Tax Extra*

# Slingerland

## "CONTEST MODEL"

### Parade Drums

WITH THE NEW ZOOMATIC  
SNARE STRAINER



No. 660W 12" x 15"



No. 660WT 12" x 15"



No. 613 10" x 28"

ILLUSTRATED FINISH—SPARKLING GOLD

The Contest Model Parade Drums were designed to save weight. The hard maple hoops are lighter than metal hoops. Supplied with the new Zoomatic snare strainer—the smoothest, fastest acting and most sturdy strainer ever designed. The shells of the Contest Model are molded 3-ply veneers with solid maple inside reinforcing hoops. Separate tension twin lugs afford even tensioning of the heads. Supplied with Sound-King Plastic heads unless calf heads are specified. Both parade and tenor drums are equipped with a tone control.

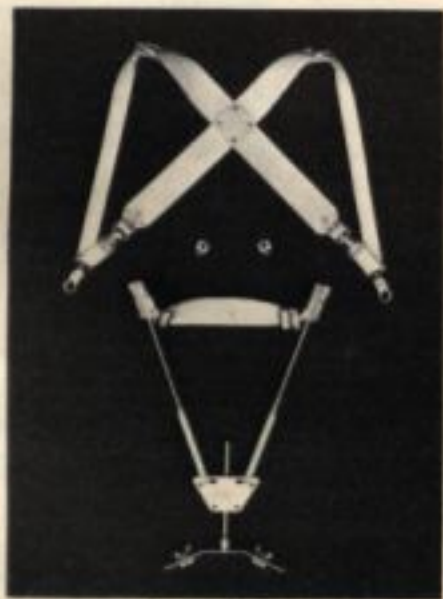

\* No. 819 \* Hi Stepper ..... \$29.95  
Pat. No. 3,021,744

## CONTEST MODEL PARADE AND TENOR DRUMS

ZOOMATIC SNARE STRAINER—SEPARATE  
TENSION—TWIN STREAMLINED LUGS

(With Hard Maple Hoops and Chrome Plated Hardware)

|      | Sticks and Sling Included             | Price<br>Parade<br>Drum | Price<br>Matching<br>Tenor Drum |
|------|---------------------------------------|-------------------------|---------------------------------|
| 536W | 10"x14" Choice of lacquer or mahog.   | \$67.50                 | 536WT .. \$67.00                |
| 521W | 10"x15" Choice of lacquer or mahog.   | 70.00                   | 521WT .. 69.50                  |
| 522W | 12"x15" Choice of lacquer or mahog.   | 77.50                   | 522WT .. 77.00                  |
| 524W | 12"x16" Choice of lacquer or mahog.   | 79.00                   | 524WT .. 78.50                  |
| 658W | 10"x14" Choice of pearl & inlaid hps. | 79.50                   | 658WT .. 79.00                  |
| 659W | 10"x15" Choice of pearl & inlaid hps. | 84.50                   | 659WT .. 84.00                  |
| 660W | 12"x15" Choice of pearl & inlaid hps. | 92.50                   | 660WT .. 92.00                  |
| 662W | 12"x16" Choice of pearl & inlaid hps. | 94.50                   | 662WT .. 94.00                  |

Excise Tax Extra

Pearl inlaid hoops on lacquer model drums, EXTRA \$1.50  
Gut or Nylon Snares, EXTRA..... 2.00

## CONTEST MODEL SCOTCH BASS DRUMS

SEPARATE TENSION—TWIN STREAMLINED LUGS

Chrome Plated (Sticks and sling included, specify white or khaki)

|         |                                       | Price Lacquer<br>or Mahogany | Price<br>Pearl |
|---------|---------------------------------------|------------------------------|----------------|
| No. 610 | 8"x26" Sep tens twin lug Scotch drum  | \$112.00                     | \$132.00       |
| No. 611 | 10"x26" Sep tens twin lug Scotch drum | 112.00                       | 132.00         |
| No. 612 | 8"x28" Sep tens twin lug Scotch drum  | 121.00                       | 141.00         |
| No. 613 | 10"x28" Sep tens twin lug Scotch drum | 121.00                       | 141.00         |

Excise Tax Extra

Pearl inlaid hoops come with all pearl models.  
Pearl inlaid hoops on lacquer model drums, EXTRA \$3.00

# Slingerland

## "TOURNAMENT MODEL"

### Parade Drums

WITH THE NEW ZOOMATIC  
SNARE STRAINER



No. 408 10" x 28"

No. 706WT 12" x 15"

No. 706W 12" x 15"

ILLUSTRATED FINISH—RED AND YELLOW LACQUER

### TOURNAMENT MODEL PARADE AND TENOR DRUMS

SEPARATE TENSION—CENTER STREAMLINED LUG—ZOOMATIC STRAINER  
Sticks and Sling Included

With Hard Maple Hoops  
and Chrome Plated Metal Parts

Choice of

|      |                           | Price<br>Parade<br>Drum | Price<br>Matching<br>Tenor Drum |
|------|---------------------------|-------------------------|---------------------------------|
| 699W | 10"x14" Mahog. or lacquer | \$63.50                 | 699WT .. \$63.00                |
| 700W | 10"x15" Mahog. or lacquer | 67.50                   | 700WT .. 67.00                  |
| 701W | 12"x15" Mahog. or lacquer | 73.50                   | 701WT .. 73.00                  |
| 703W | 12"x16" Mahog. or lacquer | 76.00                   | 703WT .. 75.50                  |
| 704W | 10"x14" Pearl finishes    | 75.50                   | 704WT .. 75.00                  |
| 705W | 10"x15" Pearl finishes    | 80.50                   | 705WT .. 80.00                  |
| 706W | 12"x15" Pearl finishes    | 88.50                   | 706WT .. 88.00                  |
| 708W | 12"x16" Pearl finishes    | 91.50                   | 708WT .. 91.00                  |

PEARL INLAID HOOPS COME WITH ALL PEARL MODELS *Excise Tax Extra*  
Pearl inlaid hoops on lacquer model drums, EXTRA ..... \$1.50  
Gut or Nylon Snares, EXTRA ..... 2.00

### TOURNAMENT MODEL SCOTCH BASS DRUMS

SEPARATE TENSION CENTER—STREAMLINED LUG

Chrome Plated (Sticks and sling  
included, specify white or khaki)

|     |                                           | Price Lacquer<br>or Mahogany | Price<br>Pearl |
|-----|-------------------------------------------|------------------------------|----------------|
| 606 | 8"x26" Sep. tens. center lug—Scotch drum  | \$107.00                     | \$127.00       |
| 605 | 10"x26" Sep. tens. center lug—Scotch drum | 107.00                       | 127.00         |
| 607 | 8"x28" Sep. tens. center lug—Scotch drum  | 116.00                       | 136.00         |
| 608 | 10"x28" Sep. tens. center lug—Scotch drum | 116.00                       | 136.00         |

PEARL INLAID HOOPS COME WITH ALL PEARL MODELS *Excise Tax Extra*  
Pearl inlaid hoops on lacquer model drums, EXTRA ..... \$3.00

The Tournament Model Parade drums, with their maple hoops and separate tension center lug, are extremely light. The new Zoomatic snare strainer is standard equipment. The shells are molded, 3-ply veneer with solid maple inside reinforcing hoops. Both parade and tenor drums are supplied with a tone control. Sound-King plastic heads are standard unless calf heads are requested.

### New Vertical Tenor Drum Holder



VERTICAL TENOR DRUMS ARE BECOMING  
MORE AND MORE POPULAR WITH  
MARCHING BANDS

No. 816 Vertical tenor drum holder. White lacquer and chrome ..... \$20.00  
(Holder comes complete as shown with two large carrying hooks for tenor drum, sling, waist strap and adjustable angle holder.)

# Slingerland

## "LEGION HEIR MODEL"

### Parade Drums

TRIPLE CHROME PLATED



No. 574 10" x 14"



No. 574T 10" x 14"



No. 630 10" x 28"

ILLUSTRATED FINISH—MAHOGANY

### LEGION HEIR MODEL PARADE AND TENOR DRUMS

SINGLE TENSION—STUD CENTER SUPPORTS—  
CHROME PLATED—THROW-OFF STRAINER—  
STICKS AND SLING INCLUDED

(Specify white or khaki)

| CHROME PLATED                             |                                         | Price   | Matching Tenor Drum |
|-------------------------------------------|-----------------------------------------|---------|---------------------|
| No. 571                                   | 9" x 13" Junior Model, Mahogany only    | \$36.00 | No. 571T \$35.50    |
| No. 574                                   | 10" x 14" Mahogany or lacquer           | 45.00   | No. 574T 44.50      |
| No. 575                                   | 10" x 14" Mahogany or lacquer, six rods | 42.00   | No. 575T 41.50      |
| No. 519                                   | 10" x 15" Mahogany or lacquer           | 50.00   | No. 519T 49.50      |
| No. 644                                   | 12" x 15" Mahogany or lacquer           | 52.00   | No. 644T 51.50      |
|                                           |                                         |         | Excise Tax Extra    |
| Gut or Nylon Snares                       |                                         |         | \$ 2.00 Extra       |
| Choice of pearl finishes and inlaid hoops |                                         |         | 10.00 Extra         |
| Pearl inlaid hoops on lacquer models      |                                         |         | 1.50 Extra          |

### LEGION HEIR MODEL SCOTCH DRUMS

SINGLE TENSION—CENTER STUDS

(Sticks and sling included, specify white or khaki)

| CHROME PLATED                               |                                   | Mahogany or Lacquer | Pearl Finishes   |
|---------------------------------------------|-----------------------------------|---------------------|------------------|
| No. 601                                     | 8" x 26" Legion Heir Scotch Drum  | \$82.00             | \$102.00         |
| No. 602                                     | 10" x 26" Legion Heir Scotch Drum | 82.00               | 102.00           |
| No. 640                                     | 8" x 28" Legion Heir Scotch Drum  | 94.00               | 114.00           |
| No. 630                                     | 10" x 28" Legion Heir Scotch Drum | 96.00               | 114.00           |
|                                             |                                   |                     | Excise Tax Extra |
| Pearl Inlaid Hoops on Lacquer Models, extra |                                   |                     | \$ 3.00          |

Legion Heir Model Parade Drums are designed for schools and Drum Corps with a limited budget. They have the superior Slingerland workmanship throughout. The Rapid Snare Strainer gives you an instant throw off and on. The shells are molded 3-ply veneers with solid maple inside reinforcing hoops. Note the new streamlined hooks. The drums are single tension with a stud center support. Sound King Plastic Heads are supplied unless calf heads are requested. Sticks and slings are included in the prices shown.



No. 1726 ROD MOUNT LEG REST, CHROME..\$6.80



No. 1727 SHELL MOUNT LEG REST, CHROME..\$6.80

# PARADE AND SNARE DRUM SLINGS



No. 1153

## STANDARD WEB BASS DRUM SLING

Made of wide webbing that crosses in the back and places entire drum weight on the shoulders and back. Metal parts nickel plated. Adjustable.

- No. 1153K (Khaki).....\$4.00
- No. 1153W (White)..... 4.00

SPECIFY KHAKI OR WHITE SLINGS



No. 815

## WEB PARADE DRUM SLING

Made of wide webbing that helps distribute weight of drum and will not tire the shoulders. Has a new type swivel snap that is strong and durable.

- No. 815K (Khaki) .....\$2.00
- No. 815W (White)..... 2.00

## WEB BASS DRUM SLING

Using the cross belt arrangement but supported by a waist belt so as to distribute the weight in a more even manner. Metal parts nickel plated. This new type sling has a wide range of adjustment and a rapid snap back buckle.

- No. 818K (Khaki).....\$4.50
- No. 818W (White)..... 4.50

No. 818

## NEW MARCHING AND STROLLING SNARE DRUM HARNESS



No. 820 Complete Jack Lee Harness .. \$17.00

# DRUM HEAD LETTERING AND EMBLEMS

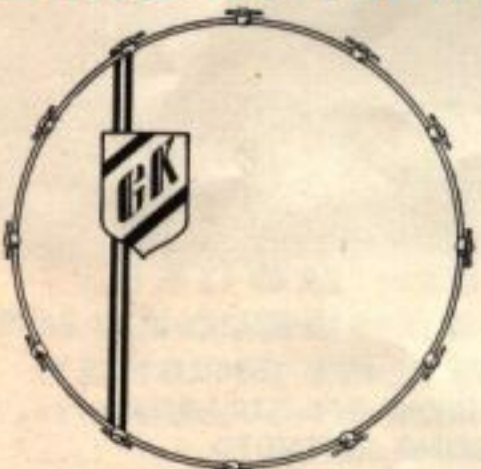

No. 832

## MONOGRAM DESIGN

Not a decal; must be painted on a drum head. Please state size of head. Prices below do not include price of head.

- No. 832 One color (black unless specified) monogram with two letters in monogram.....\$9.50
- No. 832-A With two additional letters outside of monogram also.....\$10.00

## DRUM CORPS EMBLEMS

American Legion. Regulation American Legion transfer emblem in colors.

- No. 484—6".....\$2.00
- No. 485—9"..... 2.50

American Legion Auxiliary Emblem. Regulation American Legion Auxiliary Transfer Emblem in colors.

- No. 488—6".....\$1.50

V.F.W. Emblems. Regulation Veterans of Foreign Wars Emblems in colors.

- No. 490—6".....\$2.00
- No. 491—9"..... 2.50

Eagle Emblems. Regulation emblems in colors.

- No. 489.....\$ .50
- (These prices include putting emblem on shell in factory.)



No. 488



No. 490

## PAINTING OF HEADS

Special head lettering and painting is done to order. For special work send in sketches, color samples, etc., to insure accuracy and complete satisfaction. Work is done by skilled artists, using fast color oils.

## SPECIAL LETTERING

- No. 833 For name of school, town, state, in 1-color black letters. Per letter.....\$1.20
  - No. 834 For same lettering in 2-color outlined letters. Per letter.....\$1.50
- (Slightly higher for extra fancy, or unusual style or special design letters)



No. 489



No. 484

## LEG RESTS



No. 1726



No. 1727

No. 1726 Rod Mount, Chrome. \$6.80

No. 1727 Shell Mount, Chrome. \$6.80

Fit any model drum, will not mar appearance. Adjustable in any position instantly. Wide cradle prevents bruises. Also, folds against drum when not in use. Leg Rest is designed to oscillate with leg movement while on the march. Has shock absorbing feature.

## WHISTLE



No. 1036

- No. 1036 Chrome metal.....\$1.20
  - No. 1035 Bakelite..... .50
- Finest whistles made. Cut through with a shrill sound for clear signals.

# Slingerland LYRAS

## THE NEW SLINGERLAND BELL LYRA

- With the beautiful new chrome plated tapered tubular frame, will not dent
- New gum rubber bar mounts
- Large 1 1/4 inch wide by 3/8 inch thick alloy bars
- Raised chromatics
- Beautiful nylon plumes

The Bell Lyra is a must for marching and concert bands. It can also be used for orchestra bells.

**No. 1655**—Band Lyra, 2 octaves, A to A, 25 bars, 1 1/4" wide and of 3/8" bar stock. Tuned A-440. Complete with white nylon plumes and mallet. . . . . **\$135.00**  
Tax Extra

**No. 1651** Quality leather carrying holster and sling, specify white or black when ordering. . . . . **\$10.30**

**No. 1658** Double Lyra holster, specify white or black leather. . . . . **18.50**

**No. 1656** Mackintosh cover for band lyra. . . . . **9.00**

**No. 1657** Concert stand for band lyra, adjustable, will adjust to horizontal or any angle desired. . . . . **18.00**

**No. 1740** Nylon Lyra mallets per pair **3.00**

**No. 1653** Nylon plumes, white only. . . . . pair **6.00**

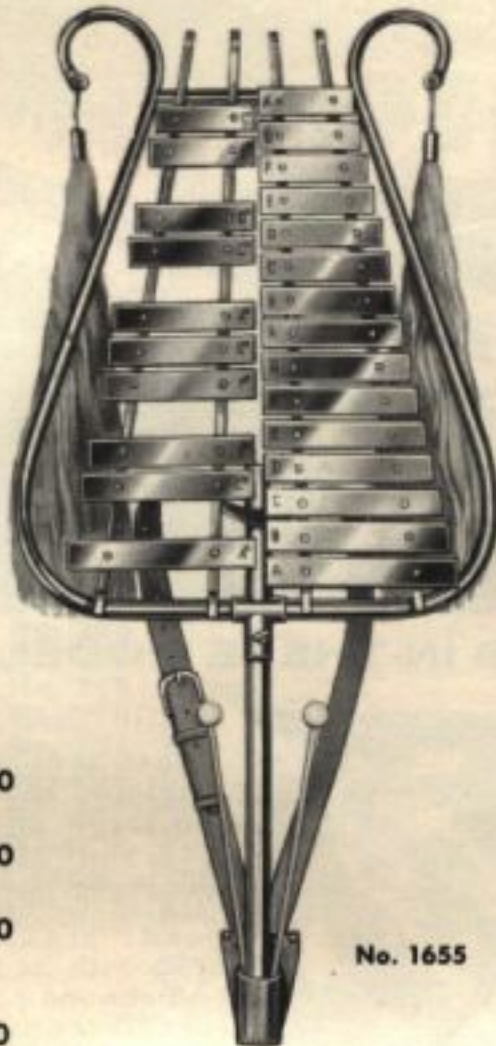

No. 1655

## IMPROVED BAR MOUNT



Each bar of the Slingerland lyras is individually suspended on live rubber mounts which increases the bar volume and resonance 80% over the felt strip type. Bars are special aluminum alloy, full size, accurately tuned. Frames are rugged, strong, and the entire frame is buffed and polished to a high lustre. Bell lyras may also be used as orchestra bells in concert band or orchestra.

## NYLON ONE-PIECE BELL-LYRA MALLETS

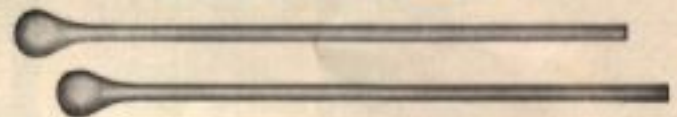

Moulded from one-piece solid nylon. New material not affected by heat or cold. No handle or ball to come loose. Will not break. Gives clear, brilliant tone.

**No. 1740**—Pair . . . . . **\$3.00**

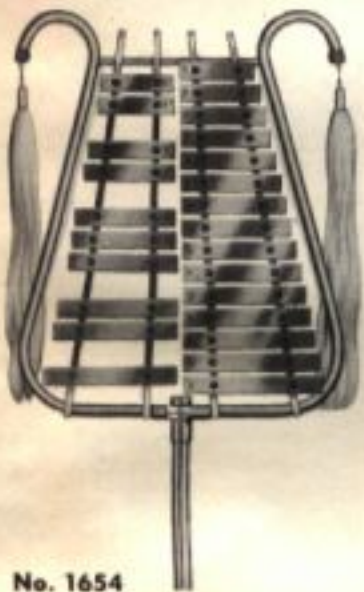

No. 1654

## NEW "Lite-Wate" Bell-Lyra

This new "Lite-Wate" Bell-Lyra has everything in quality and efficiency for the younger school band member.

**No. 1654**—25 Bars A-to-A—1" wide by 1/4" thick—A440 Pitch. Weight 7 lbs. 23" high, 16 1/2" wide. Polished Aluminum Alloy Bars—Nickel plated tubular frame. Mallets and plumes (white only). . . . . **\$77.00**  
Tax Extra

**No. 1659**—Waterproof Zipper Cover for 1654 Bell-Lyra. . . . . **\$8.60**

OTHER ACCESSORIES LISTED UNDER BELL-LYRA ABOVE

## NEW SLINGERLAND REGULAR BELL LYRA

Tubular steel frame, chrome plated. 1 1/4" x 3/8" bars, made of aluminum alloy, highly polished. Countersunk holes with lock nuts on back. Overall height 28", width at widest point 21". Weight 12 lbs.

**No. 1662**—Regular bell lyra, complete with nylon plumes and mallet. . . . . **\$100.00**  
Tax Extra

**No. 1651**—Leather holster sling, specify white or black **\$10.30**

**No. 1656**—Mackintosh cover for bell lyra. . . . . **9.00**

**No. 1653**—Nylon plumes, white only. . . . . **6.00**

(You can dye plumes to match your band or corps colors)

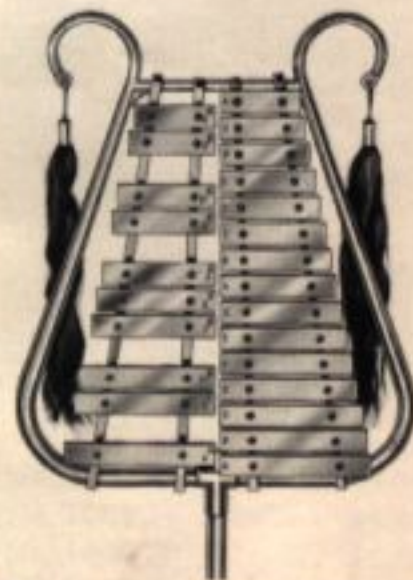

No. 1662



## LEATHER BELL-LYRA HARNESS—DOUBLE

Fully adjustable. Heavy sole leather. Distributes weight evenly on shoulders. Sturdy pocket.

**No. 1658B**—Black Leather. . . . . **\$18.50**

**No. 1658W**—White Leather. . . . . **\$18.50**



## LEATHER BELL-LYRA HARNESS—SINGLE

Adjustable all sole leather. Single harness construction. Pocket won't break down. Comfortable.

**No. 1651B**—Black Leather. . . . . **\$10.30**

**No. 1651W**—White Leather. . . . . **\$10.30**



## BELL LYRA STAND

A perfect bell lyra stand, will adjust to horizontal or any angle desired. Made of heavy gauge steel, nickel plated.

**No. 1657**—Lyra Stand Nickel. . . . . **\$18.00**



# The Sensational Slingerland New SPOTLITE Baton



only  
**\$4.50**  
LIST

**NEW 3/16", 1/2", and 5/16" DIA. SHAFTS IN THESE MODELS—PERFECTLY BALANCED**

### THE BALL

Streamlined design, beautifully proportioned, gracefully tapered, and of gleaming white rubber.



### THE SHAFT

Most accurately hammered indentations throw off sparkling sunbursts of light to make the illusion of tremendous speed. Maximum glitter with its triple, hand chrome plating. Great strength is another feature of the SPOTLIGHT model.



### HOW TO ORDER

Place baton ball against neck of the performer and extend arm horizontally so that tip of the baton comes to about the first or second joint of the SECOND finger. (A variation of 1/2 to 1 inch is permissible.) Proper length is very important to make maneuvering easy and graceful. 5/16" dia. shaft is the favorite size.

### Hammered 3/16" Shaft

|           |          |                  |
|-----------|----------|------------------|
| No. H-718 | 18" long | } \$4.50<br>EACH |
| No. H-720 | 20" long |                  |
| No. H-722 | 22" long |                  |
| No. H-724 | 24" long |                  |
| No. H-726 | 26" long |                  |
| No. H-728 | 28" long |                  |
| No. H-730 | 30" long |                  |

### Plain 3/16" Shaft

|           |          |                  |
|-----------|----------|------------------|
| No. P-718 | 18" long | } \$3.50<br>EACH |
| No. P-720 | 20" long |                  |
| No. P-722 | 22" long |                  |
| No. P-724 | 24" long |                  |
| No. P-726 | 26" long |                  |
| No. P-728 | 28" long |                  |
| No. P-730 | 30" long |                  |

### Hammered 5/16" Shaft

|           |          |                  |
|-----------|----------|------------------|
| No. H-618 | 18" long | } \$4.50<br>EACH |
| No. H-620 | 20" long |                  |
| No. H-622 | 22" long |                  |
| No. H-624 | 24" long |                  |
| No. H-626 | 26" long |                  |
| No. H-628 | 28" long |                  |
| No. H-630 | 30" long |                  |

### Plain 5/16" Shaft

|           |          |                  |
|-----------|----------|------------------|
| No. P-618 | 18" long | } \$3.50<br>EACH |
| No. P-620 | 20" long |                  |
| No. P-622 | 22" long |                  |
| No. P-624 | 24" long |                  |
| No. P-626 | 26" long |                  |
| No. P-628 | 28" long |                  |
| No. P-630 | 30" long |                  |

### Hammered 1/2" Shaft

|           |          |                  |
|-----------|----------|------------------|
| No. H-518 | 18" long | } \$4.50<br>EACH |
| No. H-520 | 20" long |                  |
| No. H-522 | 22" long |                  |
| No. H-524 | 24" long |                  |
| No. H-526 | 26" long |                  |
| No. H-528 | 28" long |                  |
| No. H-530 | 30" long |                  |

### Plain 1/2" Shaft

|           |          |                  |
|-----------|----------|------------------|
| No. P-518 | 18" long | } \$3.50<br>EACH |
| No. P-520 | 20" long |                  |
| No. P-522 | 22" long |                  |
| No. P-524 | 24" long |                  |
| No. P-526 | 26" long |                  |
| No. P-528 | 28" long |                  |
| No. P-530 | 30" long |                  |

### Spotlite Balls and Tips

|            |                |        |            |                |        |
|------------|----------------|--------|------------|----------------|--------|
| No. BT-12  | Tip for 3/16"  | \$ .25 | No. BT-58  | Tip for 5/16"  | \$ .25 |
| No. BB-12  | Ball for 3/16" | .75    | No. BB-58  | Ball for 5/16" | .75    |
| No. BT-916 | Tip for 9/16"  | .25    | No. BT-716 | Tip for 7/16"  | .25    |
| No. BB-916 | Ball for 9/16" | .75    | No. BB-716 | Ball for 7/16" | .75    |

### SLINGERLAND DRUM MAJOR BATON

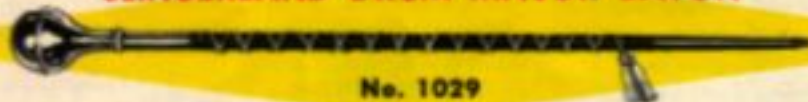

No. 1029

No. 1029 Length 41", weight 25 oz. American Legion Regulation Model with blue staff wound gold silk cord. Ball and ferrule chromium plated. \$20.00

Also available in special lacquer color with choice of red, white, blue, or blue and gold cord. \$22.00

EACH BATON IS INDIVIDUALLY PACKAGED IN A PLASTIC BAG WITH AN EYELET AT ONE END

### ALL METAL SPIRAL BATON

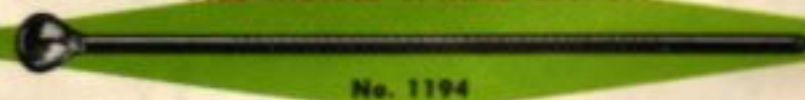

No. 1194

Lightweight spiral baton. Length 32", shaft 3/4" seamless steel tubing with center spiral. Equipped with aluminum alloy ball. Weight approximately 19 oz.

|           |                     |        |
|-----------|---------------------|--------|
| No. 1194  | Chromium 32" length | \$9.00 |
| No. 1194A | Chromium 30" length | 9.00   |

### MACKINTOSH BATON COVERS

|           |                              |        |
|-----------|------------------------------|--------|
| No. 2224C | Cover for 22" and 24" batons | \$2.00 |
| No. 2426C | Cover for 24" and 26" batons | 2.00   |
| No. 2628C | Cover for 26" and 28" batons | 2.00   |
| No. 3000C | Cover for 30" batons         | 2.00   |



No. 1026  
Baton  
Twirling  
Instruction  
Book  
\$1.25  
by Virginia  
Page

Creates an interesting and sound foundation for twirling—advancing the novice on to footwork, showmanship, grace and speed.



# ZIP-LOCK MACKINTOSH COVERS

These covers have stood the test of time. The cover protects the instrument from dust, moisture, grit, and changes of temperature.

The covers are flannel lined upon Mackintosh waterproofed cloth, strongly sewed with reinforced seams. Equipped with Talon zipper. When ordering, state the size of the drum shell measurements, model of drum, and catalogue number as listed below.

**SNARE DRUMS**

|          |           |        |
|----------|-----------|--------|
| No. 209  | 4½" x 13" | \$5.90 |
| No. 210  | 5½" x 13" | 6.00   |
| No. 211  | 5½" x 14" | 6.60   |
| No. 212  | 6½" x 14" | 6.70   |
| No. 213  | 7" x 14"  | 7.00   |
| No. 214  | 8" x 14"  | 7.00   |
| No. 215  | 6½" x 15" | 6.80   |
| No. 215A | 8" x 15"  | 7.00   |

**TOM TOMS**

|          |           |        |
|----------|-----------|--------|
| No. 200  | 8" x 12"  | \$7.00 |
| No. 201  | 9" x 13"  | 7.50   |
| No. 202  | 14" x 14" | 8.20   |
| No. 203A | 14" x 16" | 8.40   |

**TOM TOMS (Continued)**

|         |           |         |
|---------|-----------|---------|
| No. 203 | 16" x 16" | \$ 8.40 |
| No. 204 | 16" x 18" | 10.10   |
| No. 205 | 16" x 20" | 10.40   |
| No. 206 | 18" x 20" | 10.80   |
| No. 207 | 20" x 20" | 10.80   |

**BASS DRUMS**

|         |           |         |
|---------|-----------|---------|
| No. 228 | 6½" x 18" | \$ 9.00 |
| No. 229 | 14" x 18" | 12.00   |
| No. 230 | 12" x 20" | 13.00   |
| No. 232 | 14" x 20" | 13.00   |
| No. 233 | 12" x 22" | 13.50   |
| No. 234 | 14" x 22" | 13.50   |
| No. 245 | 12" x 24" | 14.20   |
| No. 246 | 14" x 24" | 14.20   |
| No. 247 | 14" x 26" | 14.50   |
| No. 249 | 8" x 26"  | 14.00   |
| No. 250 | 10" x 26" | 14.25   |
| No. 251 | 8" x 28"  | 14.50   |
| No. 252 | 10" x 28" | 14.50   |
| No. 254 | 14" x 28" | 15.00   |
| No. 255 | 10" x 30" | 16.00   |
| No. 257 | 14" x 30" | 16.00   |
| No. 258 | 16" x 30" | 16.50   |
| No. 259 | 16" x 32" | 17.50   |

**STREET DRUMS**

|         |           |         |
|---------|-----------|---------|
| No. 216 | 10" x 14" | \$ 7.50 |
| No. 218 | 10" x 15" | 7.60    |
| No. 219 | 12" x 15" | 7.70    |
| No. 221 | 12" x 16" | 8.00    |
| No. 222 | 12" x 17" | 9.00    |
| No. 223 | 12" x 18" | 9.00    |

No. 463 Mackintosh Covers for 25" x 28" Tympani. . . . . 18.50

**RAIN COVERS**

For parade drums. Clear plastic weather defying covers.

|          |                           |         |
|----------|---------------------------|---------|
| No. 1677 | for 14" shell             | \$ 3.50 |
| No. 1678 | for 15" shell             | 3.50    |
| No. 1679 | for 16" shell             | 3.50    |
| No. 1680 | for 17" shell             | 3.50    |
| No. 1681 | for 18" shell             | 3.50    |
| No. 1682 | for 10" x 28" Scotch Drum | 8.00    |

## Slingerland FIBRE CASES

**STANDARD FIBRE CASE**

A durable case made to fit any size snare drum. Has partitioned compartments to hold traps, etc.

Case is 23" long by 16½" wide x 10" deep and has flaps to hold snare drum.

\*No. 465 Standard Fibre Case . . . . . \$18.60

**PAX-ALL TRAP CASE**

A very good case for the drummer with a lot of traps. Case is 23" long and 10" wide by 21" deep. Has one partition 7" wide for accessories, leaving 16" partition for snare drum.

Tray is 22" long, 9½" wide by 5" deep.

\*No. 442 Pax-All Trap Case . . . . . \$26.00

**DELUXE FIBRE TRAP CASE**

The wood-fibre construction of this case gives you the best of protection while it is light in weight and easy to handle.

The case is 22¾" long x 16½" wide x 12¾" deep with flaps to hold snare drum. Tray is 22" long by 16" wide x 2¼" deep.

\*No. 461 Deluxe Fibre Trap Case . . . . . \$28.80

**NEW CARRY-ALL CASE**

The new case that is so popular. Partition inside to carry up to and including 22" cymbals. Inside partition to hold snare drum.

Case is 22¼" long x 13" wide x 22¼" deep.

Tray is 21⅞" long x 9¼" wide x 7" deep.

\*No. 460 Carry-All Case . . . . . \$36.20

\*No. 460W With Wheels . . . . . \$44.00

Protect your drums with these fine cases. Made of the best vulcanized fibre. All joints are securely riveted. Each case has a strong, comfortable carrying handle and leather straps with buckles to keep the case securely closed.

**SNARE DRUM AND KIT CASES**

\*No. 469 14" Round Case . . . . . \$13.00

\*No. 470 15" Round Case . . . . . 13.50

\*No. 472 14" Square Case . . . . . 13.00

\*No. 467 Hard Shell Kit Case . . . . . 24.00

\*No. 479 Modern Kit Case . . . . . 16.00

**TOM TOM CASES**

\*No. 408 8" x 12" Fibre Case . . . . . \$13.80

\*No. 409 9" x 13" Fibre Case . . . . . 14.30

\*No. 410 14" x 14" Fibre Case . . . . . 17.50

\*No. 411 16" x 16" Fibre Case . . . . . 18.50

\*No. 413 16" x 20" Fibre Case . . . . . 26.20

\*No. 414 16" x 18" Fibre Case . . . . . 24.30

\*No. 413 20" x 20" Fibre Case . . . . . 26.20

\*No. 289A Combination Case for 8" x 12" and 14" x 14" . . . . . 22.00

\*No. 416 Combination of 9" x 13" and 16" x 16" case . . . . . 31.00

\*No. 417 Single Conga Case . . . . . 29.00

\*No. 418 Fibre case for No. 302 Bongos . . . . . 21.20

\*No. 419 Fibre case for No. 301 Bongos . . . . . 21.20

**BASS DRUM CASES**

\*No. 1007 6½" x 18" . . . \$23.00

\*No. 1008 14" x 18" . . . 24.20

\*No. 1009 20" . . . . . 31.50

\*No. 1010 22" . . . . . 31.80

\*No. 1017 24" . . . . . 32.50

\*No. 1086 8" x 26" . . . . 33.30

\*No. 1106 10" x 26" . . . . 33.30

\*No. 1018 14" x 26" . . . . 33.50

\*No. 1088 8" x 28" . . . . 34.20

\*No. 1108 10" x 28" . . . . 34.20

\*No. 1019 14" x 28" . . . . 34.20

\*No. 1020 30" . . . . . 36.75

\*No. 1021 32" . . . . . 39.50

\*No. 1022 34" . . . . . 41.50

\*No. 1023 16" x 36" . . . . 64.00

\*No. 1024 18" x 40" . . . 100.00

**PARADE DRUM CASES**

\*No. 471 14" Case . . . \$15.80

\*No. 474 15" Case . . . 17.30

\*No. 475 16" Case . . . 18.00

\*No. 478 18" Case . . . 21.00



No. 465



No. 442



No. 461



No. 460



# SLINGERLAND DANCE DRUMMING BOOKS



**No. 1201**  
**Complete Instruction in Dance Drumming**  
**\$2.00**  
 by Jake Jerger

For beginners, intermediate and advanced students. What every dance drummer needs.

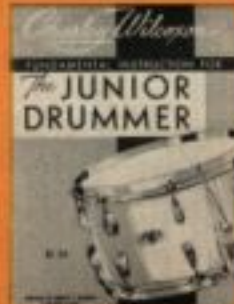

**\*No. 1112**  
**The Junior Drummer**  
**\$1.50**  
 by Charlie Wilcoxon  
 Written by a master of the art. A group of 48 lessons applied in easy progressive steps to Snare, Tom Toms and Hi-Hat.

applied in easy progressive steps to Snare, Tom Toms and Hi-Hat.



**\*No. 1115**  
**Design for the Drum Set**  
 by Don Lamond  
**\$2.50**

Hundreds of exercises written in an easy-to-understand manner by one of the leading modern drummers of our time.



**No. 1203**  
**Tricks of the Trade**  
**\$1.50**  
 by Don Osborne

One of the most modern, up-to-date books on the market, explaining in great detail, "four bar breaks," "drum fills," and a practical approach to getting around your set.



**\*No. 1192**  
**GENE KRUPA**  
**Drum Method**  
**\$3.00**

The greatest book ever written—it has everything for the swing drummer, Written and compiled by the Ace Drummerman himself. Shows his exciting brush beats, rim shot style and Hi-Hat rhythms, and explains each thoroughly.

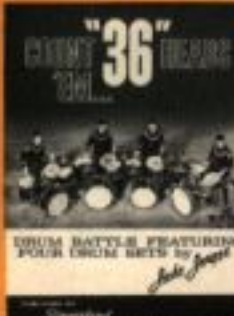

**DRUM BATTLES BY JAKE JERGER**

**No. 1210 For 2 Drum Sets \$2.50**  
**No. 1211 For 4 Drum Sets 3.00**  
**No. 1212 For 6 Drum Sets 3.50**



**\*No. 1182**  
**Developing "Drum Breaks and Fill-Ins"**  
**\$1.50**  
 by Sonny Igoe and Henry Adler

A complete study of independence with the left hand by using triplets as the main foundation. This book defines this subject in a more simple form and maintains an interest of high playing level.



**No. 1118**  
**Al Miller's 1000 Solos for the Drum Set**  
**\$1.75**

A complete study of independence with the left hand by using triplets as the main foundation. This book defines this subject in a more simple form and maintains an interest of high playing level.



**\*No. 1143**  
**Stick Control**  
 by George Stone  
**\$3.00**

An advanced instruction book dealing with the technical development of speed, endurance and hand-to-hand execution.



**No. 1174**  
**Variations of Drumming**  
**\$3.00**  
 by Ralph C. Pace

A beautifully written book in four parts designed to equip the drummer for more variations of rudiments and ideas for the very ambitious drummer.



**No. 1119**  
**Drummer's Dance Band Guide**  
 by Sam Ulano  
**\$2.50**

Solos, fills, cutting with band, phrasing, shading and basic hints to help you play with Dance Bands.



**No. 1120**  
**Thinking Drummer**  
**\$1.50**  
 by Sam Ulano

This book was written to educate the working drummer with a more rounded knowledge of all the many different styles of dance rhythms and new modern beats.

# SLINGERLAND LATIN DRUMMING BOOKS



**No. 1202**  
**Bongo Playing Made Easy**  
**\$0.50**  
 By Jake Jerger

Written for the beginner (it is not necessary that you know how to read music) with the fundamental beats for all the Latin-American dances, plus jazz beats and solos.



**\*No. 1121**  
**Authentic Conga Rhythms**  
 by Bob Evans  
**\$1.00**

All phases of Latin American rhythms are explained most thoroughly.



**\*No. 1122**  
**Authentic Bongo Rhythms**  
 by Bob Evans  
**\$1.00**

All Latin stylings are covered in complete detail. Bongos are one of today's most popular instruments.



**\*No. 1175**  
**Latin-American Rhythm Instruments and How to Play Them**  
 by Humberto Morales  
**\$3.00**

Covers completely every aspect of Latin Rhythms that could be desired.

## FREE EDUCATIONAL MATERIAL



**No. 1206**  
**Thirteen Principal Drum Rudiments**  
 Shows complete sticking of rudiments as they should be played, from very slow to fast. Great asset in improving your present drum section.



**No. 1207**  
**Cadence 1, 2, 3, 4, 5, 6**  
 Add snap to your drum section with these new and different drum cadence. Written by Haskell W. Harr for snare, tenor, bass and cymbals.



**No. 1208**  
**Interlude for Bells and Drums**  
 By Haskell W. Harr  
 The purpose of the "Interlude" is to provide music and entertainment on parade in the spot usually given to the drum section.



**No. 1209**  
**Contest Solos**  
 Here are five fine rudimental solos written specifically for competition drumming, by four of the nation's leading drum authorities. Myron Collins, C. Oscar Stover, Jim Salmon, Haskell W. Harr. "Are Yours for the Asking."

# SLINGERLAND SCHOOL AND RUDIMENTAL BOOKS



**\*No. 1186**  
Slingerland  
Drum  
Method,  
Book I  
**\$1.50**  
by  
Haskell W.  
Harr

A tremendous book for both teacher and student. Explains fully all fundamentals, notation and rudiments.



**\*No. 1181**  
Book I,  
Elementary  
**\$1.25**  
by Carl E.  
Gardner

A fine book to assist in the supervision of many students, a class, or single student. A great asset for teachers in schools.



**No. 1184**

The Snare Drum at School, Ten Terrific Books

**\$ .60 EACH**

by

Myron D.  
Collins

(Please specify book or books desired.)

Book 1—Single strokes in all time signatures.

Book 2—The elementary roll in 4/4, 3/4 and 2/4 time.

Book 3—The elementary roll in 6/4, 6/8, 3/8, 3/2 and 2/2.

Book 4—The flam valuable drill work in the most used patter.

Book 5—Dotted notes.

Book 6—Triplets and a careful explanation of 6 march time.

Book 7—Expression in drumming, combinations all previously used in rhythms, rolls and flams with accents, crescendos and diminuendos.

Book 8—Abbreviated symbols. Also a thorough drill in playing groups of six, rolls on triplets, etc.

Book 9—Drill work in the playing of the various ruffs.

Book 10—The rudiments of drumming introduced in a musical form.



**\*No. 1187**  
Slingerland  
Drum  
Method,  
Book II  
**\$1.50**

by  
Haskell W.  
Harr

Reviews carefully

previous studies with stronger emphasis on rudiments and advances the student to competition solo work.



**\*No. 1185**  
Record  
and Book  
No. 1187  
**\$4.45**

by Haskell  
Harr

Have your very own private teacher.

The recording explains (in accordance with the book) and plays rudiments—slow to fast.



**No. 1123**  
14 Modern  
Contest  
Solos for  
Snare  
Drum

by John S.  
Pratt

**\$1.50**

Composed of complex

contest material for the advanced drummer. Fourteen solos designed to really stem the interest in rudiments.



**\*No. 1124**  
The All  
American  
Drummer  
**\$3.00**

by Charlie  
Wilcoxon

150 rudimental  
solos. An  
extremely  
advanced

book. No pictures—no instruction—no explanations. 150 of the toughest drum materials ever printed.



**No. 1188**  
Drum-O-  
Wheel  
by Charles  
Alden  
**\$2.00**

A correspondence course in itself. Over 65,000 combinations of hand-to-hand sticking and accenting exercises for the drummer.



**No. 1126**  
The  
Straight  
System of  
Modern  
Drumming  
**\$2.00**

Each exercise is explained thoroughly along with many suggestions to improve sight reading.



**No. 1127**  
Modern  
Syncopated  
Rhythms  
for Drums  
By Ed  
Straight  
**\$2.00**

Syncopated rhythms are the heart of

jazz and modern drumming. Here is a book designed with a most colorful assortment of accents and intricate rhythms.



**No. 1128**  
Straight's  
System  
Analysis  
**\$2.00**

6/8 Time  
All difficulties the drummer has ever encountered in 6/8

rhythms can be overcome by thorough study and execution of the many complex exercises within.

# SLINGERLAND TYMPANI AND MARCHING BOOKS



**No. 1204**  
Slingerland  
Tympani-  
Instruction  
Manual  
**\$2.00**

by Haskell  
Harr

A modern, up-to-date, tympani method. Starts very elementary. Contains 72 pages of graduated studies, well illustrated. Much emphasis on tuning.



**\*No. 1117**  
Tympani  
Instruction  
**\$5.00**

by Alfred  
Friese and  
Alexander  
Lepak

An invaluable method for the teacher with an array of private study material for the student. The latter part of the book eases gradually into complicated, intricate study.



**\*No. 1125**  
Drummer  
on Parade  
**\$1.00**

by Charlie  
Wilcoxon

50 rudimental  
street beats  
with an extra  
touch of

modern swing to liven up any drum corp or marching band.



**No. 1183**  
March and  
Drum  
**\$1.00**

by  
Myron D.  
Collins

The snare  
drum at  
school develops a  
drum section

in a hurry. Includes snare and tenor duets, march and drum from first lesson, practical preparatory material, easy, flashy cadences.



**No. 1205**  
Tenor,  
Tenor-  
Scotch and  
Bass Drum  
Manual  
**\$1.00**

By Haskell  
Harr

Twirls and cross-over beats—well-illustrated. Book contains 11 thirty-two measure marching interludes (cadences) for bell lyra, drums, cymbals, Tenor and Scotch bass drums. For high school and college bands.



**\*No. 1173**  
The Art of  
Drum  
Majoring  
**\$2.00**

by Bob  
Roberts  
and Charles  
Scott

A complete manual for the Drum Major and Drum Majorette. The most complete book on this particular subject ever written—clear explanatory photos and complete instructions.



**No. 1193**  
Slingerland  
Complete  
Instructive  
Manual  
for G-D  
Piston  
Bugles  
**\$1.00**

by Richard  
Wilson

Accepted as the finest piston bugle manual ever written.



**No. 1027**  
Slingerland  
Drum  
Corps  
Handbook  
**\$1.00**

# PEDAL REPAIR PARTS AND REPAIR PARTS KITS

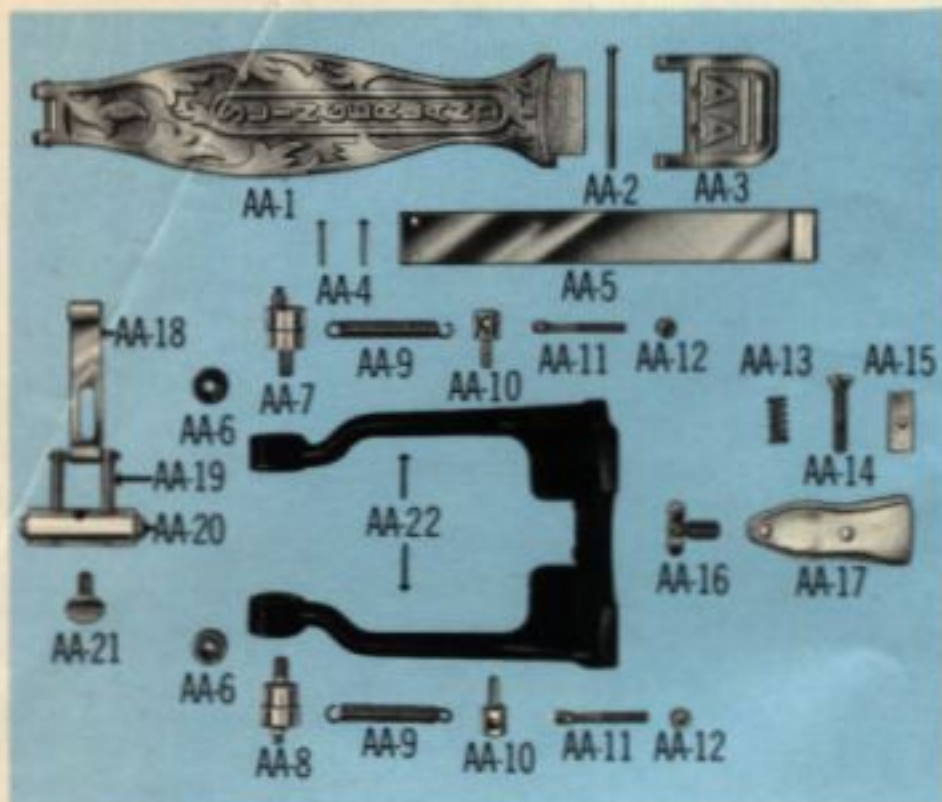

## A-A PEDAL REPAIR PARTS

|                                                   |                                            |
|---------------------------------------------------|--------------------------------------------|
| AA-1 Pedal Footboard with two Rivets . . . \$2.00 | AA-12 Adj. Nut, each . . . \$ .26          |
| AA-2 1/4 Rivet for Footboard . . . . . .10        | AA-13 Clamp Spring . . . . .10             |
| AA-3 Heel with 3 Rivets . 1.20                    | AA-14 Clamp Center Screw .16               |
| AA-4 Footboard, each . . . . .05                  | AA-15 Clamp Center Nut . .20               |
| AA-5 Footboard Strap . . . . .60                  | AA-16 Clamp Adj. Screw . .26               |
| AA-6 Roller Bearing, ea. .50                      | AA-17 Clamp . . . . . .80                  |
| AA-7 Right Bearing Stud .50                       | AA-18 Clamp Strap with Rivet . . . . . .40 |
| AA-8 Left Bearing Stud .50                        | AA-19 Rocker Post, each . .50              |
| AA-9 Spring, each . . . . .24                     | AA-20 Rocker Shaft . . . . .3.00           |
| AA-10 Spring Post Stud . .40                      | AA-21 1/4-20x1/4 wing screw .18            |
| AA-11 Adj. Screw, each . .24                      | AA-22 Main Frame . . . . .6.00             |



**ACCESSORY REPAIR PARTS  
KIT NO. A \$24.00**  
(TOTAL VALUE \$27.68)  
NO ADDITIONS OR SUBSTITUTIONS

### KIT CONSISTS OF

|           |                                                     |        |
|-----------|-----------------------------------------------------|--------|
| 16-801-11 | Crutch tips for No. 801, No. 836, No. 837 . . . . . | \$ .80 |
| 10-803-19 | Crutch tips for No. 802, No. 803, No. 804 . . . . . | 1.00   |
| 6-W-1     | Felt Washers . . . . .                              | .40    |
| 4-S-2     | Rubber Sleeves for Cymbal Holders . . . . .         | .20    |
| 2-803-13  | 10" Leather Straps for No. 803, No. 804 . . . . .   | .80    |
| 1-836-1AC | Top Cymbal Holder for Hi-Hat . . . . .              | 2.00   |
| 2-938-6   | Cam Wire Triangles . . . . .                        | .60    |
| 2-W-21    | Metal Washers for Hi-Hat . . . . .                  | .60    |
| 2-W-25    | Metal Washers for Cymbal Holder . . . . .           | .60    |
| 2-CB-1    | 1/4-20 x 1/4 Carriage Bolts . . . . .               | .40    |
| 2-CB-2    | 1/4-20 x 1/4 Carriage Bolts . . . . .               | .50    |
| 2-938-13  | 7/4" Leather Straps for No. 938 . . . . .           | .80    |
| 3-803-18  | 1/4-14 Wing Nuts . . . . .                          | .90    |
| 20-WN-3   | 1/4-20 Wing Nuts . . . . .                          | 3.00   |
| 10-W5-7   | 1/4-20 x 1/4 Flat Wing Screws . . . . .             | 2.50   |
| 10-W5-5   | 10-24 x 1/4 Wing Screws . . . . .                   | 2.00   |
| 10-686    | 1/4-24 Clamp Screws . . . . .                       | 2.40   |
| 4-E7      | Epic Pedal Springs . . . . .                        | .48    |
| 6-E6      | S Hooks . . . . .                                   | .36    |
| 6-E5      | Pedal Tension Screws . . . . .                      | 1.50   |
| 3-938-9   | Tempo-King Pedal Springs . . . . .                  | .72    |
| 3-AA-9    | AA Pedal Springs . . . . .                          | .72    |
| 1-        | 18-Compartment Plastic Box . . . . .                | 2.20   |
| 2-172-4   | Bolt, Nut, Washer for No. 172 Holder . . . . .      | 1.00   |
| 2-804-18  | Clamp for Hi-Hat Top Tube . . . . .                 | 1.00   |



**DRUM REPAIR PARTS  
KIT NO. D \$34.00**  
(TOTAL VALUE \$37.54)  
NO ADDITIONS OR SUBSTITUTIONS

### KIT CONSISTS OF

|          |                                                 |         |
|----------|-------------------------------------------------|---------|
| 2-565    | Small Lugs . . . . .                            | \$ 2.40 |
| 2-567    | Medium Center Lugs . . . . .                    | 2.40    |
| 12-      | 1/2 x 1/4 Pinhead Screws for Lugs . . . . .     | .60     |
| 12-      | Collar Screw Washers . . . . .                  | .24     |
| 2-566    | Bass Drum Lugs . . . . .                        | 2.40    |
| 6-1080-1 | Tone Control or Pedal Adjusting Knobs . . . . . | 2.40    |
| 12-972   | Rods 1 1/4", 2", 2 1/2", 3 1/4" . . . . .       | 7.20    |
| 8-974    | Collar Screw Hooks . . . . .                    | 3.20    |
| 2-685    | New Bass Drum Hooks . . . . .                   | 2.00    |
| 1-685B   | New Bass Drum Threaded Hook . . . . .           | 1.00    |
| 2-674A   | 2 1/4" Snare Butts . . . . .                    | 2.00    |
| 2-684    | Double Claw Hooks, not threaded . . . . .       | 1.60    |
| 1-684B   | Threaded Double Claw Hook . . . . .             | .90     |
| 6-970    | Drum Keys . . . . .                             | 3.00    |
| 2-950    | Drum Key Holders . . . . .                      | 2.00    |
| 2-674B   | 2 1/4" Snare Butts . . . . .                    | 2.00    |
|          | 12-Compartment Plastic Box . . . . .            | 2.20    |

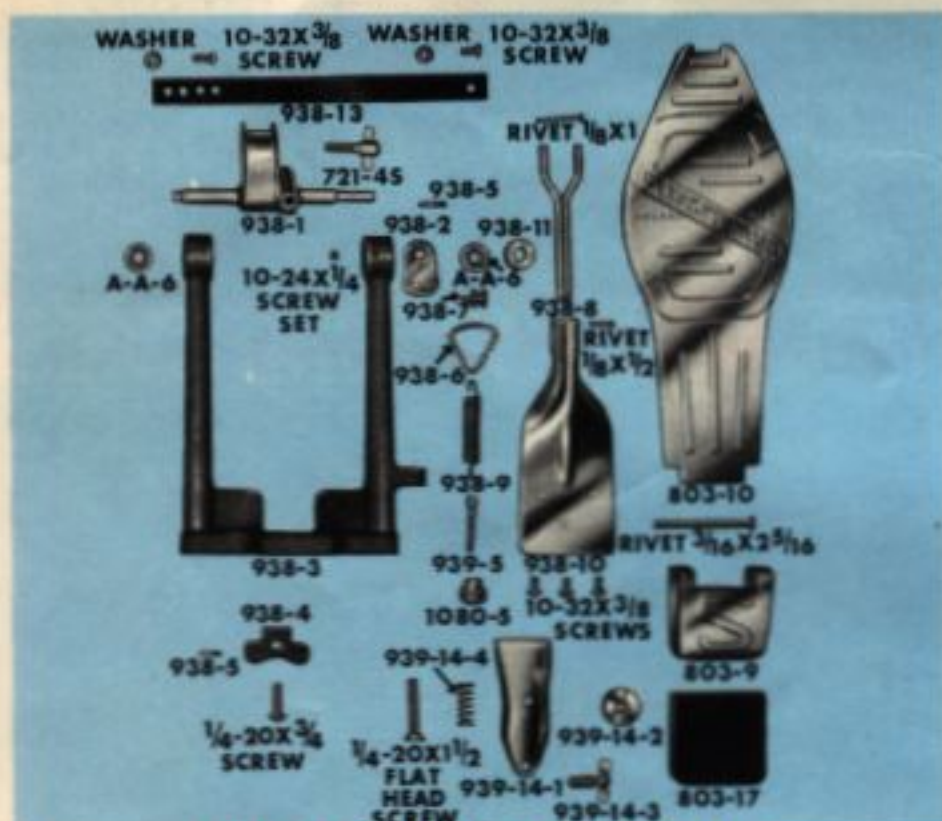

## NO. 938 PEDAL REPAIR PARTS

|                                            |                                                    |
|--------------------------------------------|----------------------------------------------------|
| AA-6 Roller bearing, each . . . . . \$ .50 | 938-13 Leather strap, 6 1/2" long . . . . . \$ .40 |
| 721-45 Clamp screw . . . . . .24           | 939-5 Eye screw . . . . . .25                      |
| 803-9 Heel and rivet . . . . . 1.50        | 939-14-1 Hoop clamp . . . . . 1.50                 |
| 803-10 Footboard . . . . . 2.50            | 939-14-2 Knurled nut . . . . . .30                 |
| 803-17 Rubber heel pad . . . . . .50       | 939-14-3 Hoop clamp screw . .24                    |
| 938-1 Rocker . . . . . 4.00                | 939-14-4 Hoop clamp adjusting . . . . .10          |
| 938-2 Rocker cam . . . . . .60             | 1080-5 Adjusting nut . . . . .26                   |
| 938-3 Main frame . . . . . 6.00            | <b>Screws</b>                                      |
| 938-4 Clevis . . . . . .80                 | 1/4-20x1/4 Screws . . . . . .15                    |
| 938-5 Clevis pin . . . . . .10             | 1/4-20x1 1/4 Screws . . . . . .20                  |
| 938-6 Cam wire triangle . .30              | 10-24x1/4 Screws . . . . . .10                     |
| 938-7 Cam spring . . . . . .30             | 10-32x1/4 Screws . . . . . .10                     |
| 938-8 Footboard straps, pair . .80         | <b>Rivets</b>                                      |
| 938-9 Spring . . . . . .24                 | 1/2 x 1/2 Rivet . . . . . .05                      |
| 938-10 Footboard shovel 1.00               | 1/2 x 1 Rivet . . . . . .10                        |
| 938-11 Bushing . . . . . .20               | 1/2 x 2 1/4 Rivet . . . . . .20                    |

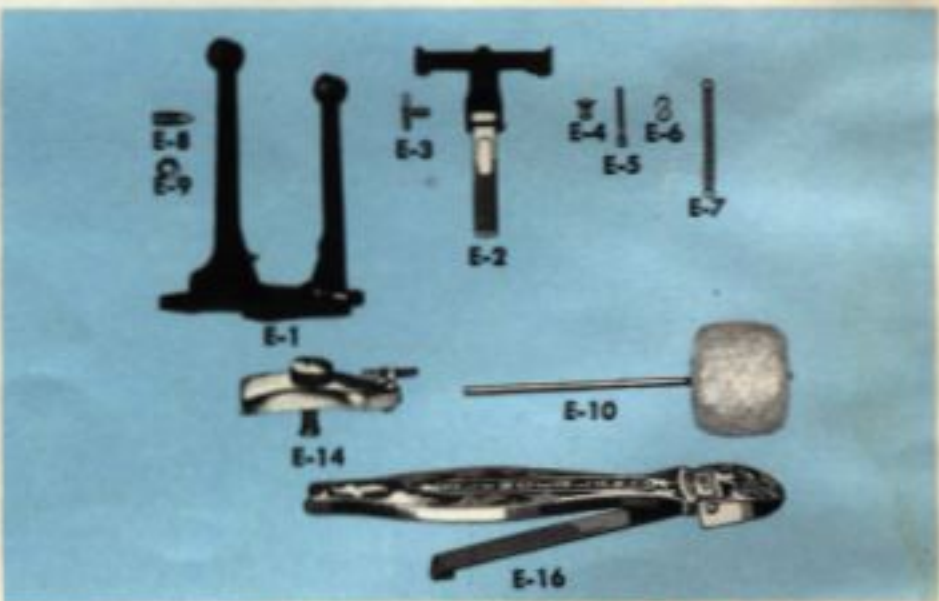

## EPIC PEDAL REPAIR PARTS

|                                                  |                                                |
|--------------------------------------------------|------------------------------------------------|
| E-1 Main frame . . . . . \$5.00                  | E-8 Bearing screw . . . . . \$ .40             |
| E-2 Rocker and strap . . . . . 3.00              | E-9 Hex nut . . . . . .10                      |
| E-25 Metal rocker strap with rivet . . . . . .60 | E-10 Hoop ball and rod . . . . . 2.50          |
| E-3 1/4-20 x 1/4" wing screw . .25               | E-14 Hoop clamp complete . 2.00                |
| E-4 Tension knob . . . . . .40                   | E-15 Wing screw for hoop clamp . . . . . .25   |
| E-5 Tension screw . . . . . .25                  | E-15N Knurled nut for hoop clamp . . . . . .30 |
| E-6 S-Hook . . . . . .12                         | E-16 Complete footboard . . 3.00               |
| E-7 Tension spring . . . . . .24                 |                                                |

# SNARES, SNARE STRAINER AND SLING REPAIR PARTS

## SNAPPY SNARES



For better response and improved tonal effects, insist on Slingerland Snappy Snares. Made of rust resisting, flexible steel soldered into end plates that keep the snares in position while under tension. When ordering, see that the correct model and size of drum is mentioned.

|            |                                                                          |      |        |
|------------|--------------------------------------------------------------------------|------|--------|
| No. A-1212 | 12 strands, 12" long for 13" drum                                        | each | \$3.00 |
| No. A-1213 | 12 strands, 13" long for 14" drum                                        | each | 3.00   |
| No. A-1214 | 12 strands, 14" long for 15" drum                                        | each | 3.00   |
| No. A-1612 | 16 strands, 12" long for 13" drum                                        | each | 3.30   |
| No. A-1613 | 16 strands, 13" long for 14" drum                                        | each | 3.30   |
| No. A-1614 | 16 strands, 14" long for 15" drum                                        | each | 3.30   |
| No. A-1615 | 16 strands, 15" long for 16" drum                                        | each | 3.30   |
| No. A-2009 | 20 strands, 9" long for 10" drum                                         | each | 3.50   |
| No. A-2012 | 20 strands, 12" long for 13" drum                                        | each | 3.50   |
| No. A-2013 | 20 strands, 13" long for 14" drum                                        | each | 3.50   |
| No. A-2014 | 20 strands, 14" long for 15" drum                                        | each | 3.50   |
| No. A-2015 | 20 strands, 15" long for 16" drum                                        | each | 3.50   |
| No. R-2016 | 20 strands, 16" long (with band) metal for 14" drum                      | each | 3.50   |
| No. S-2016 | 20 strands, 16" long (for Super model) 14" drum                          | each | 3.50   |
| No. Z-2014 | 20 strands, 14" long (for 14" dia.) dance drums with Zoomatic strainer   | each | 3.50   |
| No. Z-2015 | 20 strands, 15" long (for 15" dia.) concert drums with zoomatic strainer | each | 3.50   |

## SILK WIRE WOUND SNARES

State Shell Diameter

|         |                        |        |
|---------|------------------------|--------|
| No. 809 | For Orchestra and Band | \$1.25 |
| No. 824 | For Drum Corps         | 1.25   |

## GUT SNARES

|         |               |        |
|---------|---------------|--------|
| No. 811 | For Orchestra | \$4.00 |
| No. 812 | For Band      | 4.50   |

## SLING HOOKS



|         |                                        |        |
|---------|----------------------------------------|--------|
| No. 450 | Chrome snap eye for metal or wood hoop | \$ .30 |
| No. 447 | Chrome snap eye for congos             | 1.00   |
| No. 688 | Carrying hook for bass drums           | 1.00   |
| No. 953 | Swivel snap for slings                 | 1.00   |

Chrome



## NEW ZOOMATIC SNARE STRAINER

|         |                                                       |        |         |
|---------|-------------------------------------------------------|--------|---------|
| No. 978 | Zoomatic strainer for dance and concert drums, Chrome | Chrome | \$12.00 |
| No. 979 | Zoomatic strainer for parade drums, chrome            |        | 12.00   |
| No. 980 | Butt for Zoomatic strainer on dance and concert drums |        | 3.00    |

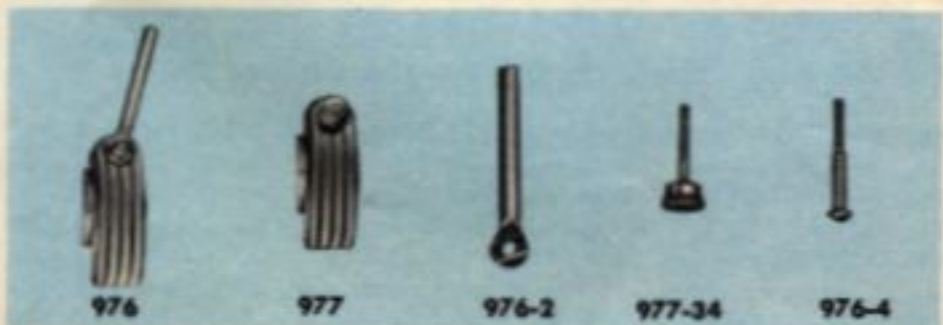

## SUPER STRAINER

|            |                                      |        |        |
|------------|--------------------------------------|--------|--------|
| No. 976    | Super strainer, throw-off side       | Chrome | \$6.00 |
| No. 977    | Super strainer, tension or butt side |        | 5.00   |
| No. 976-2  | Super strainer handle                |        | 1.00   |
| No. 976-4  | Handle screw                         |        | .50    |
| No. 977-34 | Tension screw                        |        | 1.00   |

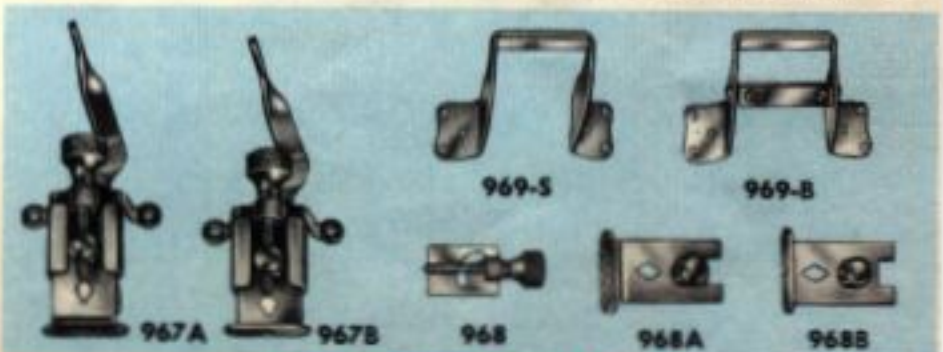

## RADIO KING STRAINER

|           |                                                                            |        |        |
|-----------|----------------------------------------------------------------------------|--------|--------|
| No. 967-A | Radio King strainer with 12 holes in slides for gut, silk, or wire snares  | Chrome | \$6.50 |
| No. 967-B | Radio King strainer with one hole in slide to attach metal strap on snares |        | 6.50   |
| No. 968   | Adjusting screw and slide for No. 967-A or No. 967-B                       |        | 1.20   |
| No. 968-A | Top slide with 12 holes                                                    |        | 1.80   |
| No. 968-B | Top slide with one hole                                                    |        | 1.80   |
| No. 969-5 | Radio King Bracket, strainer side                                          |        | 2.50   |
| No. 969-8 | Radio King Bracket, butt side                                              |        | 2.50   |



## RAPID STRAINER

|            |                                                                  |        |        |
|------------|------------------------------------------------------------------|--------|--------|
| No. 673-A  | Rapid strainer with holes for silk, wire or gut snares           | Chrome | \$4.50 |
| No. 673-B  | Rapid wide gate strainer with holes for silk, wire or gut snares |        | 4.50   |
| No. 671-A  | Top slide for No. 673-A strainer                                 |        | 2.00   |
| No. 671-B  | Top slide for No. 673-B strainer                                 |        | 2.00   |
| No. 672    | Adjusting screw for rapid strainer                               |        | .80    |
| No. 673-1  | Strainer frame                                                   |        | .80    |
| No. 673-2L | Strainer handle and link                                         |        | .80    |
| No. 674-A  | 2 1/4" Butt                                                      |        | 1.00   |
| No. 674-B  | 2 3/4" Butt                                                      |        | 1.00   |

# LUGS, HOOKS, HOOPS, RODS, HOOP CLAMP AND TONE CONTROL



## TENSION CASINGS (LUGS)

NOTE: When ordering state type of drum and whether single or separate tension.

### NEW STYLE LUGS

Chrome

- No. 565—Small Snare drum, Tom-Tom and parade drum lug, Chrome. . . . . \$1.20
- No. 566—Medium bass drum lug, Chrome. . . . . 1.20
- No. 567—Separate tension, double end lug, Chrome. . . . . 1.20
- No. 567S—Single tension double end lug, Chrome. . . . . 1.20
- No. 568—Super Tension parade drum lug. . . . . 1.75
- No. 569—Super Tension bass drum lug. . . . . 1.30

### OLD LUGS

- No. 561—Discontinued—No. 566 Lug will fit
- No. 548—Discontinued. Large, Single tension, Bass Drum Lug.
- No. 549—Discontinued. Large, Separate tension Bass Drum Lug.
- No. 547—Discontinued—No. 567 Lug will fit
- No. 547-S—Discontinued—No. 567 will fit
- No. 564—Discontinued—No. 565 Lug will fit

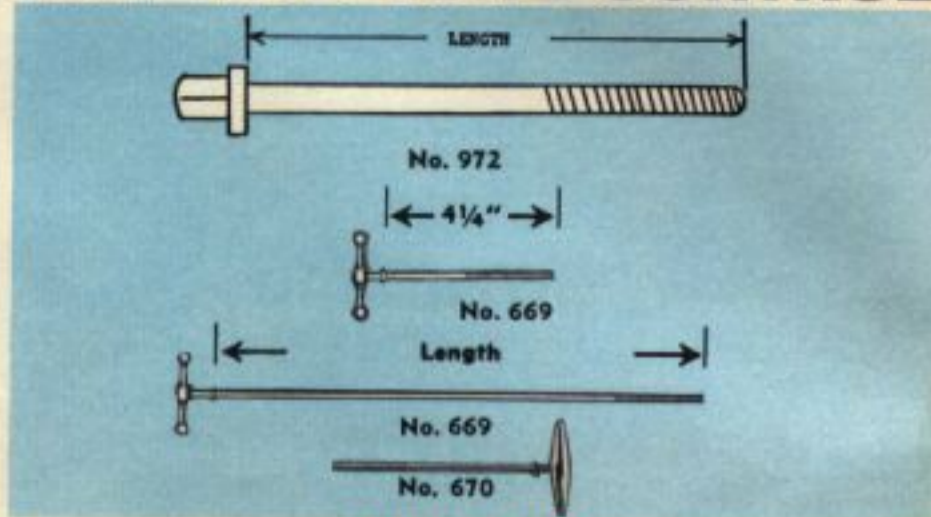

## DRUM RODS

### CORRECT WAY TO MEASURE A DRUM ROD

Measure the distance from the collar to the end of the thread for the length of the rod (see above). There are two types of tensioning ends for rods—square head, for orchestra, parade and scotch drums—tympani handle for concert bass drums.

All rods have a 12-24 thread, except some old single tension parade drums had rods with a 10-24 thread.

### BE SURE TO STATE LENGTH

- No. 972 Square Head Rods, Lengths—  
1 1/4", 2", 2 3/16", 3 3/16", 4 1/4", 4 3/4", 5 1/4", 6 1/8". Chrome  
Specify Length. . . . . \$ .60
- No. 972 Long Square Head Rods.  
Lengths—9 1/2", 10 1/2", 12 1/2". Specify Length. . . . . .70
- No. 669 Tympani Handle Rods for Bass Drums.  
Specify Length.  
4 1/4" . . . . . .90  
13 1/2" or 15 1/2" . . . . . 1.10
- No. 670 New Tympani Handle Rods.  
4 1/4" or 7 1/2" . . . . . .90  
13 1/2" or 15 1/2" . . . . . 1.10

## DRUM KEY and HOLDER

- No. 970 Chrome Key. . . . . \$ .50
- No. 950 Chrome Keyholder. . . . . 1.00

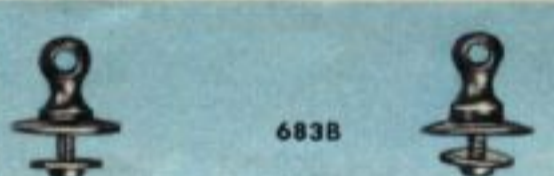

## CENTER STUDS

- No. 683P Complete Center Stud for Parade Drums. . . \$ .50
- No. 683B Complete Center Stud for Bass Drums. . . . .50



## HOOKS

- No. 685 New Streamlined Hook for Bass Drums and Parade Drums. Chrome \$1.00
- No. 685B New Streamlined Hook threaded for Single Tension Bass and Parade Drums. . . . . 1.00
- No. 684 Double Claw Hook, not threaded. . . . .80
- No. 684B Threaded Double Claw Hook for Single Tension Bass and Parade Drums. . . . .90
- No. 974 Collar Screw Hook for L Shape Hoops. . . . .40

## TONE CONTROLS

- No. 1080 Old Style Tone Control, Chrome. . . \$3.50
- No. 1082 New Style Tone Control. . . . . 2.50
- No. 1080-1 Tone Control Knob. . . . . .40

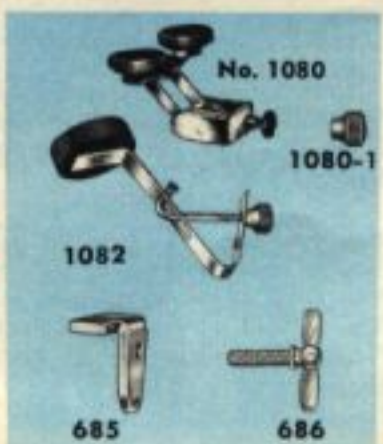

## TOM TOM CLAMP AND SCREW

- No. 685L Hoop Clamp, Chrome. . . . . .30
- No. 686 1/4"-24 Clamp Screw, Chrome. . . . . .24

## METAL HOOPS

- Rim Shot triple flanged metal counter hoop*
- No. 851 Batter Hoop, Chrome. State size and number of holes. . . . . \$ 9.50
- No. 853 Snare Hoop, Chrome. State size and number of holes. . . . . 10.00
- L-Shape Metal Counter Hoop*
- No. 325 Batter Hoop, Chrome, State size. . . . . 5.50
- No. 326 Snare Hoop, Chrome, State size. . . . . 6.00
- Flat Metal Counter Hoop*
- No. 327 Batter Hoop, Chrome State size. . . . . 4.00
- No. 328 Snare Hoop, Chrome, State size. . . . . 4.50

## WOOD COUNTER HOOPS FOR SNARE DRUM STATE SIZE, SNARE OR BATTER

- No. 1014M Maple. . . . . \$ 3.00
- No. 1014L Choice—Lacquer Colors. . . . . 3.50
- No. 1014P Choice—Pearl Inlay. . . . . 4.50

## WOOD COUNTER HOOPS FOR BASS DRUM

- Up to and including 28"—Over 28" add \$2.00
- No. 1015M Maple. State size. . . . . \$ 6.00
- No. 1015L Choice—Lacquer Colors State size. . . . . 6.50
- No. 1015P Choice—Pearl Inlay State size. . . . . 7.50



# Slingerland

## REPAIR PARTS

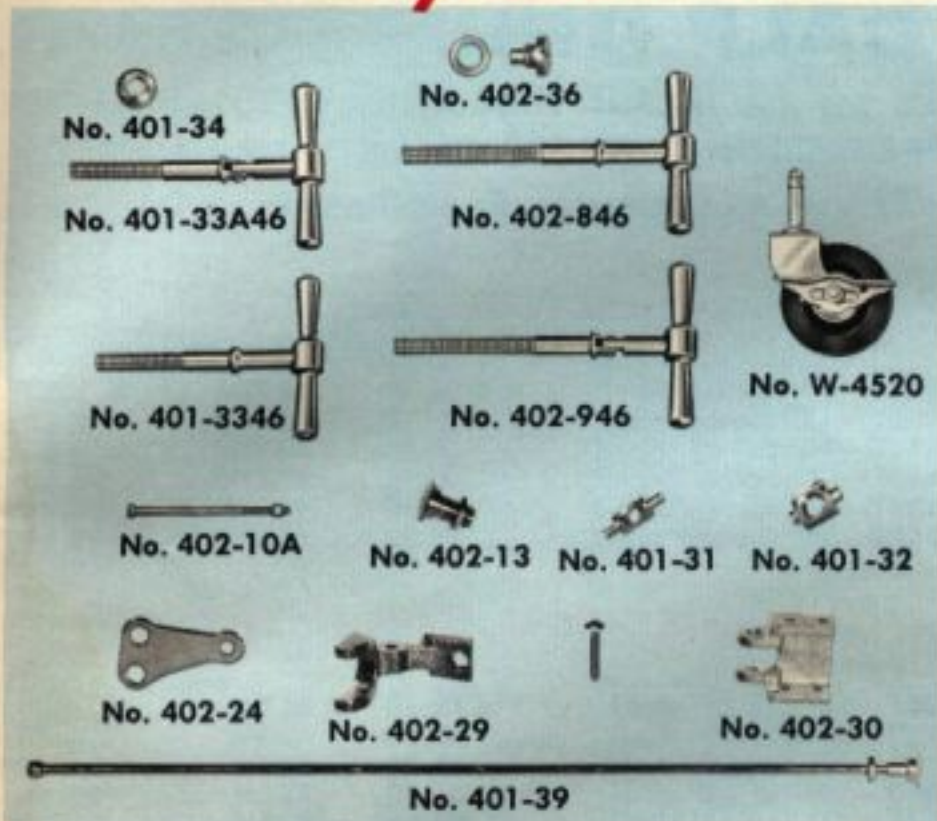

### TIMPANI REPAIR PARTS

|               |                                         | Chrome |
|---------------|-----------------------------------------|--------|
| No. 401-31    | Small Lug Stud                          | \$ .40 |
| No. 401-32    | Large Lug Stud                          | .60    |
| No. 401-34    | Tension Rod Bearing Washer              | .40    |
| No. 401-39    | Complete Pull Rod—Specify kettle size.  | 3.00   |
| No. 401-3346  | Rod and Handle for #350, #400 and #401  | 4.00   |
| No. 401-33A46 | Flip Handle & Rod for #350, #400 & #401 | 4.50   |
| No. 402-10A   | Clutch Release Rod and Nut              | 1.00   |
| No. 402-13    | Pedal Assembly Screw and Nut            | .80    |
| No. 402-24    | Lug Side Plate                          | .50    |
| No. 402-29    | Bell Crank and Rivet                    | 2.00   |
| No. 402-30    | Bell Crank Bracket and Rivet            | 2.00   |
| No. 402-36    | Pivot Screw and Washer for Clutch       | 1.00   |
| No. 402-846   | Tension Rod and Handle for #402         | 4.20   |
| No. 402-946   | Flip Handle and Rod for #402            | 4.70   |
| No. W-4520    | Caster for All Timpani                  | 2.00   |

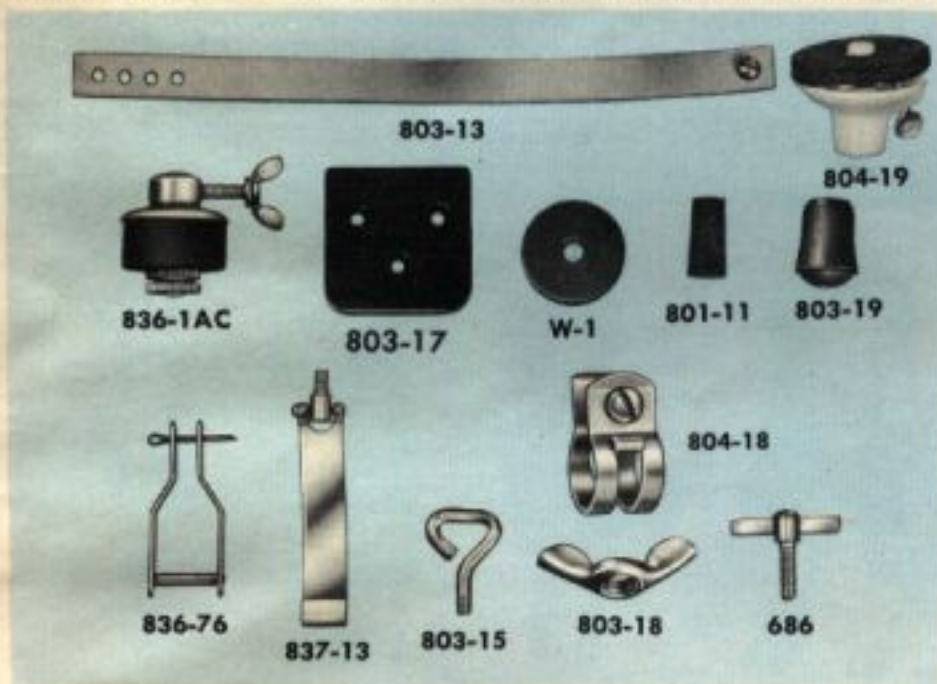

### HI HAT PARTS

|            |                                                  | Chrome |
|------------|--------------------------------------------------|--------|
| No. W-1    | 1 7/16" O.D. x 3/8" I.D. 7/16" Thick Felt Washer | \$ .10 |
| No. 686    | 1/4-24 Clamp Screw                               | .24    |
| No. 801-11 | Crutch Tip for #836 and #837                     | .05    |
| No. 803-13 | 9" Leather Strap                                 | .30    |
| No. 803-15 | Strap eye Screw                                  | .20    |
| No. 803-19 | Crutch Tip for #803 and #804                     | .10    |
| No. 803-17 | Black Rubber Heal Cushion, with Screws           | .60    |
| No. 803-18 | 7/16-14 Wing Nut                                 | .30    |
| No. 804-19 | New Bottom Cymbal Holder                         | .80    |
| No. 836-1C | Bottom Cymbal Holder                             | .50    |
| No. 836-76 | Pull Strap Assembly for #836                     | 1.00   |
| No. 837-13 | Pull Strap and Screw for #837                    | .90    |
| No. 804-18 | Clamp for Top Tube                               | .50    |

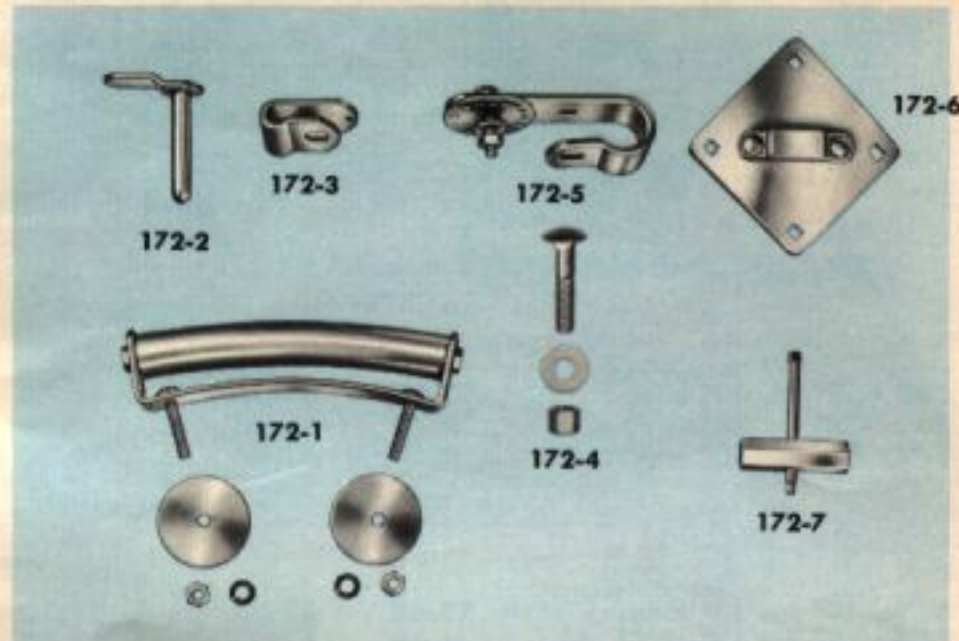

### No. 172 HOLDER PARTS

|            |                                              |               |
|------------|----------------------------------------------|---------------|
| No. 172-1  | Rail, Complete with Washers, Bolts, and Nuts | Chrome \$6.00 |
| No. 172-2  | Short Rod and Tongue                         | 2.00          |
| No. 172-2L | Long Rod and Tongue                          | 2.50          |
| No. 172-3  | Female Clamp                                 | 1.00          |
| No. 172-4  | Bolt, Nut and Washers                        | .50           |
| No. 172-5L | Rail Clamp and Ratchet for 22" BD            | 5.00          |
| No. 172-5L | Rail Clamp and Ratchet for 18" & 20" BD      | 5.00          |
| No. 172-6  | Diamond Plate                                | 3.50          |
| No. 172-7  | Hex Key                                      | 1.00          |



### RUBBER TIPS AND SLEEVES

|            |                                               | Chrome |
|------------|-----------------------------------------------|--------|
| No. 721-5  | For #721 and #1280                            | \$ .05 |
| No. 801-11 | For #801, #836, #837, and #957 Stands         | .05    |
| No. 801-12 | Plastic Sleeve for #801 and #802 Snare Stands | .20    |
| No. 803-19 | Crutch Tip for #802, #803, #804, and #838     | .10    |
| No. 900-18 | Crutch Tip for #900 Stand                     | .10    |
| No. 838-22 | Crutch Tip for #838 Throne                    | .30    |

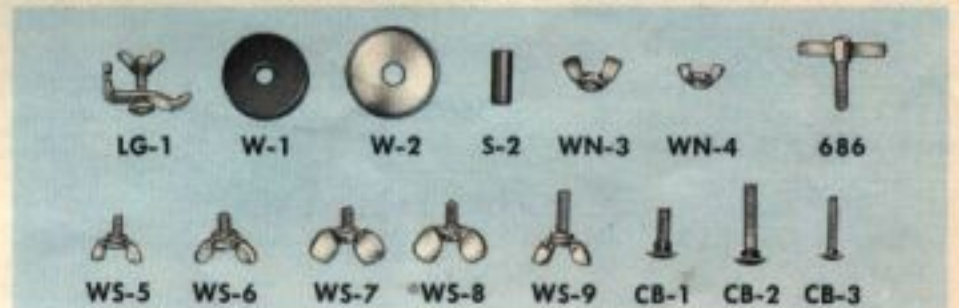

### MISCELLANEOUS SCREWS, NUTS AND WASHERS

|          |                                                    | Chrome |
|----------|----------------------------------------------------|--------|
| No. CB-1 | 1/4-20 x 3/4 Carriage Bolt                         | \$ .20 |
| No. CB-2 | 1/4-20 x 1 1/4 Carriage Bolt                       | .25    |
| No. CB-3 | 10-24 x 1 Carriage Bolt                            | .20    |
| No. LG-1 | Complete Rod Clamp for Leg Rest                    | .90    |
| No. S-2  | Rubber Sleeve for Cymbal Holder                    | .05    |
| No. W-1  | 1 7/16" O.D. x 3/8" I.D. x 7/16" Thick Felt Washer | .10    |
| No. W-2L | Metal Cymbal Washer for Hi Hats                    | .30    |
| No. W-25 | Metal Cymbal Washer for Cymbal Arms                | .30    |
| No. WN-3 | 1/4-20 Wing Nut                                    | .15    |
| No. WN-4 | 10-24 Wing Nut                                     | .15    |
| No. 686  | 1/4-24 Clamp Screw                                 | .24    |
| No. WS-5 | 10-24 x 3/8 Wing Screw for Cymbal Stands           | .20    |
| No. WS-6 | 1/4-20 x 1/2 Wing Screw                            | .20    |
| No. WS-7 | 1/4-20 x 1/2 Flat Wing Screw                       | .25    |
| No. WS-8 | Discontinued                                       |        |
| No. WS-9 | 1/4-20 x 3/4 Wing Screw                            | .25    |



# NEW *Slingerland* "SOUND KING" PLASTIC HEADS

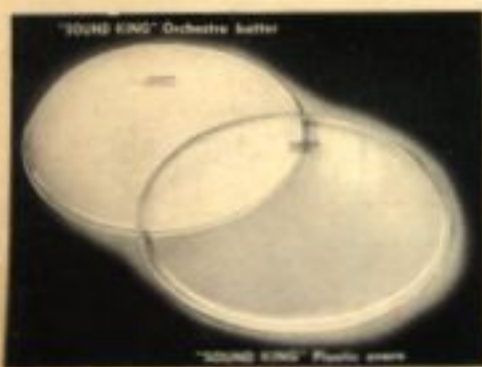

The new SLINGERLAND SOUND KING PLASTIC HEADS made of Mylar with the finest finish ever developed. The new all-metal mounting with the special non-ferrous alloy center is guaranteed not to pull out. The outside channel has rounded corners to prevent cutting the edge of the head.

... Be sure to specify size and whether Orchestra, Tom Tom, Parade or Bass when ordering from your dealer.

### ORCHESTRA BATTER

Made of special gauge Mylar with the most durable rough bone white finish for the most sensitive brush response and superb tone.

|               |         |
|---------------|---------|
| 13BO 13"..... | \$ 7.00 |
| 14BO 14"..... | 7.50    |
| 15BO 15"..... | 8.00    |

### TRANSPARENT SNARE

Extra thin Mylar that gives a superior sound and snap. Used on either orchestra or parade drums.

|              |         |
|--------------|---------|
| 135 13"..... | \$ 6.00 |
| 145 14"..... | 6.50    |
| 155 15"..... | 7.00    |
| 165 16"..... | 7.50    |

### PARADE BATTER

Made of extra strong two-ply Mylar to take hard playing with heavy sticks. Smooth bone white finish with built-in muffer strap.

|               |         |
|---------------|---------|
| 13PB 13"..... | \$ 7.20 |
| 14PB 14"..... | 7.70    |
| 15PB 15"..... | 8.20    |
| 16PB 16"..... | 8.70    |
| 18PB 18"..... | 9.70    |

### TOMTOM BATTER

Perfect thickness for the real tomtom sound. Smooth bone white finish Mylar.

|               |         |
|---------------|---------|
| 12TT 12"..... | \$ 6.50 |
| 13TT 13"..... | 7.00    |
| 14TT 14"..... | 7.50    |
| 15TT 15"..... | 8.00    |
| 16TT 16"..... | 8.50    |
| 18TT 18"..... | 9.75    |
| 20TT 20"..... | 17.00   |

### BASS DRUM HEADS

With built-in muffer strap. Smooth bone white Mylar and superb sound. Mole skin patch at beating spot on 18", 20" and 22".

|               |         |
|---------------|---------|
| 18BD 18"..... | \$15.00 |
| 20BD 20"..... | 17.00   |
| 22BD 22"..... | 18.00   |
| 24BD 24"..... | 19.00   |
| 26BD 26"..... | 21.00   |
| 28BD 28"..... | 22.00   |
| 30BD 30"..... | 23.00   |
| 32BD 32"..... | 25.00   |

### SOUND KING TIMPANI HEADS

|              |         |              |         |
|--------------|---------|--------------|---------|
| 23T 23"..... | \$20.00 | 28T 28"..... | \$24.00 |
| 25T 25"..... | 21.00   | 29T 29"..... | 25.00   |
| 26T 26"..... | 22.00   | 30T 30"..... | 27.00   |

\*Patent Applied For

# NEW *Slingerland* "SOUND MASTER" PLASTIC HEADS

MOUNTED ON A WHITE PLASTIC HOOP

### BATTER SIDE FIELD DRUMS

|               |        |
|---------------|--------|
| 13BF 13"..... | \$4.75 |
| 14BF 14"..... | 4.95   |
| 15BF 15"..... | 5.25   |
| 16BF 16"..... | 5.55   |

### BATTER SIDE ORCHESTRA DRUMS

|                |      |
|----------------|------|
| 13BOR 13"..... | 4.75 |
| 14BOR 14"..... | 4.95 |
| 15BOR 15"..... | 5.25 |
| 16BOR 16"..... | 5.55 |

### SNARE SIDE FIELD DRUMS

|               |        |
|---------------|--------|
| 13SF 13"..... | \$3.95 |
| 14SF 14"..... | 4.35   |
| 15SF 15"..... | 4.70   |
| 16SF 16"..... | 4.95   |

### SNARE SIDE ORCHESTRA DRUMS

|               |      |
|---------------|------|
| 13SO 13"..... | 3.95 |
| 14SO 14"..... | 4.35 |
| 15SO 15"..... | 4.70 |
| 16SO 16"..... | 4.95 |

## AND SOUND EFFECTS

### PROFESSIONAL TRIANGLES

|                              |        |
|------------------------------|--------|
| 951 6", 3/16" dia. nickel... | \$1.85 |
| 785 8", 3/8" dia. nickel...  | 2.20   |
| 786 10", 1/2" dia. nickel... | 2.95   |

(Price includes beater)

No. 793 Triangle Suspender Wood Knob and String... \$ .20

### TRIANGLE CLIP HOLDER

The triangle clip holder has a fish string for efficiently suspending the triangle. Clip fits music stand or bass drum hoops.

No. 794 Clip Holder... \$1.50

### WRIST BELLS

No. 795 Wrist Bells... \$ .80

### SLAPSTICK

Made of hard maple with a strong spring giving it the whip effect.

No. 797 Slapstick... \$4.50



### TAMBOURINES

Professional grade solid maple shell, with easy speaking jingles securely mounted. Equipped with best grade genuine calf heads.

|                        |        |
|------------------------|--------|
| RT-7 7" Tambourine,    |        |
| 7 Jingles.....         | \$4.90 |
| RT-8 8" Tambourine,    |        |
| 7 Jingles.....         | 5.80   |
| RT-10 10" Tambourine,  |        |
| 9 Jingles.....         | 7.50   |
| RT-17 10" Tambourines, |        |
| double row of          |        |
| 17 Jingles.....        | 9.75   |

### DRUM MAJOR WHISTLE

|                        |        |
|------------------------|--------|
| No. 1036 Metal.....    | \$1.20 |
| No. 1035 Bakelite..... | .50    |

### ADDITIONAL SOUND EFFECTS

The following sound effects are excellent for their tonal effects, quality of materials and construction. These effects have been used for many years by leading drummers everywhere with complete satisfaction. Guaranteed to give maximum satisfaction and service.

(Items Listed Alphabetically)

|                                              |         |
|----------------------------------------------|---------|
| No. 988—Baby Cry.....                        | \$ 1.50 |
| No. 966—Bantam Rooster.....                  | 1.50    |
| No. 992—Cuckoo Call, Metal.....              | 3.00    |
| No. 985—Hen Cackle.....                      | 1.50    |
| No. 987—Jaybird.....                         | 1.50    |
| No. 796—All Wood 3-Toned Locomotive.....     | 12.00   |
| No. 986—Peacock.....                         | 1.50    |
| No. 965—Shanghai Rooster.....                | 1.50    |
| No. 964—Dunghill Rooster.....                | 1.50    |
| No. 989—Utility Bird Whistle.....            | 1.65    |
| No. 959—Metal Cyclone Whistle.....           | 3.85    |
| No. 960—Metal Megaphone Cyclone Whistle..... | 9.00    |



# Slingerland

## SUPERIOR PEARL FINISHES



MARINE PEARL



NEW COMBINATION — SPARKLE FINISHES AVAILABLE IN ANY TWO OF THE SEVEN SPARKLING PEARLS



SPARKLING CHAMPAGNE PEARL

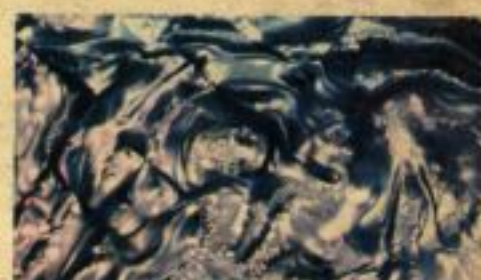

BLACK DIAMOND PEARL



BLUE AGATE PEARL



GRAY AGATE PEARL



LIGHT BLUE PEARL



OYSTER PINK PEARL



BLUE RIPPLE PEARL

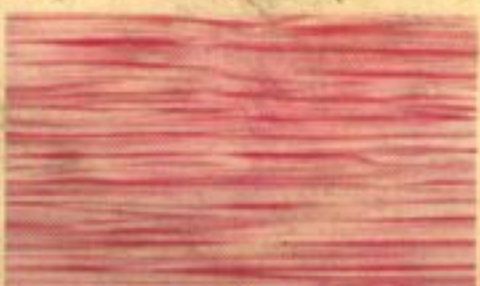

RED RIPPLE PEARL



SPARKLING SILVER PEARL



SPARKLING BLUE PEARL



SPARKLING GOLD PEARL



SPARKLING RED PEARL



SPARKLING PINK PEARL



SPARKLING GREEN PEARL



BLACK SPARKLE PEARL

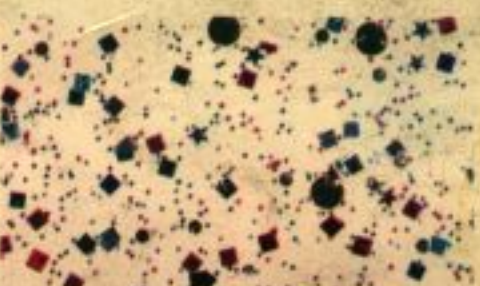

FIESTA PEARL



WHITE SATIN FLAME PEARL\*



RED SATIN FLAME PEARL\*



BLUE SATIN FLAME PEARL\*



GOLD SATIN FLAME PEARL\*



GREEN SATIN FLAME PEARL\*

(NOT ILLUSTRATED—BLACK BEAUTY, WHICH IS SOLID BLACK)

Slingerland pearls are made of the finest materials available. Pearl finishes increase the life and beauty of your equipment. The hard glossy surface prevents scratching, chipping or peeling, due to the difference in the coefficient

of expansion of pearl and the shell, combination sparkle pearls cannot be guaranteed against a slight opening which sometimes develops between the edges. This will not hinder the looks, strength or tone of the drum.

\*New Satin Flame finishes are available at slightly higher prices—add to list price \$12 for Bass Drums, \$7 for 14", 16", 18" Toms, \$3 for 12" & 13" Toms, \$3 for Snare Drums.

SLINGERLAND DRUM CO., 6633 NORTH MILWAUKEE AVENUE, NILES 48, ILLINOIS

© COPYRIGHT SLINGERLAND DRUM COMPANY 1964