

Ludwig 71
CATALOG NUMBER



LUDWIG TOTAL PERCUSSION

LUDWIG

Ludwig, serving the music and educational fields since 1909, is recognized the world over as the standard of quality and excellence. More Ludwig products are preferred and used by professionals, amateurs and educators than all others.

Ludwig has earned this position of leadership and customer confidence through years of experience and performance, creative initiative in product design, and uncompromising craftsmanship in manufacture. Always aware of the ever changing demands made upon its products, Ludwig is constantly innovating and improving.

The music and educational fields also look to Ludwig for creative new concepts and approaches to performance and teaching. Ludwig's extensive staff of experienced experts continually promote new concepts that meet the needs of the present and future.

Ludwig Industries

1728 N. Damen Ave., Chicago, Illinois 60647
Phone 312/276-3360 • Cable: LUDRUM, Chicago



INDUSTRIES

...designs for the future

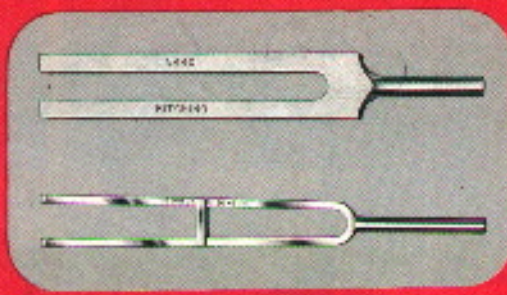

Prices effective December 16, 1970, F.O.B. Factory—Subject to change without notice. All drums and timpani in this catalog are priced and supplied with Ludwig WEATHER MASTER plastic heads, calf heads extra depending on market conditions.

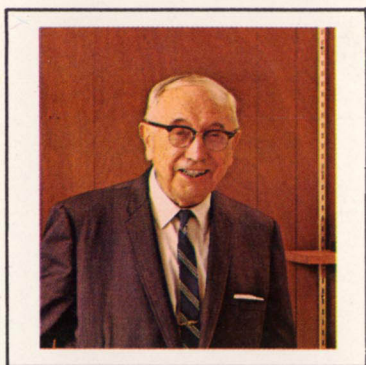

WM. F. LUDWIG, SR.
President and Founder



WM. F. LUDWIG, JR.
Executive Vice President,
General Manager

The personnel of Ludwig Industries pledge themselves to one goal . . . that of serving you and the music world. Many are accomplished musicians of national and international reputations who bring a wealth of experience and creative new ideas to the music industry. They are alert to the rapidly changing requirements and opportunities for improving their products and services. When you consider LUDWIG products, consider the people behind them . . . people with experience, imagination and craftsmanship.



ROBERT HILL
Credit Manager



JOHN MAHONEY
Comptroller



JOHN MOOS
West Central Sales



ROBERT SOUTHEY
Central Sales



EDWARD C. HOLTZ
East Central Sales



NICK RAVINE
South Atlantic Sales



RICHARD J. RICHARDSON
Vice Pres., Musser-Kitching Div.



FRANK K. PEPPLER
Vice President, Sales



FRANK BAXPEHLER
Vice Pres., International Div.



LEO PALAS
North East Sales



JIM ELKINS
South Sales



CHARLES IVINS
Customer Service Manager



RICHARD GERLACH
West Coast Sales



HENRY M. LARSON
North Pacific Sales



RAY NELSON
North Atlantic Sales



WILLIAM H. FORD
Central Atlantic Sales



JACK GUENTHER
Central Sales



VERN BUSH
East Coast Sales



JIM PATTERSON
North West Sales



GEORGE HUMES
South West Sales



GLEN LARSON
South Pacific Sales

LUDWIG INDUSTRIES...SERVING
 THE MUSIC WORLD SINCE 1909
 INDIVIDUAL SKILL AND PERSONAL PRIDE IN THE PRODUCT
 THEY PRODUCE, MAKE LUDWIG THE STANDARD
 OF QUALITY AND EXCELLENCE THE WORLD OVER.



DICK SCHORY
 Sr. Vice President, Marketing



BUD DOTY
 Product Mgr.— Electronics Div.



JAMES SEWREY
 Education Director—Product Mgr.



FRANK ARSENAULT
 Educational Representative



WILLIAM CHALONER
 Exhibit & Publication Manager



RICHARD L. BROWN
 Advertising Manager



LUDWIG...total outfits for the total drummer



LUDWIG DELUXE CLASSIC

Here is the drum outfit made to survive in the world of the professional drummer. The DELUXE CLASSIC is built to withstand the rough treatment of road travel—and the constant setting up and tearing down that comes with it. Featured is a 5" x 14" SUPRA-PHONIC "400" Snare Drum, 14" x 22" Bass Drum, 9" x 13" mounted Tom Tom, 16" x 16" Floor Tom Tom, and the 201 Speed King pedal. Also featured are Ludwig's extra heavy duty ATLAS Drum stand, BIG BEAT Hi-Hat Stand and two cymbal stands. All stands are of heavy gauge steel and triple chrome plated to ensure years of heavy duty service.

Oyster Black Pearl Illustrated

No. 990P—DELUXE CLASSIC OUTFIT, Choice of pearl finishes, chrome, WITHOUT CYMBALS . . . **\$616.00**

Recommended PAISTE— Formula 602 CYMBALS for Deluxe Classic Outfit: 2-14" Matched Hi-Hat, 1-18" Thin Crash, 1-20" Medium Ride.

No. 226—Set of 4 PAISTE-Formula 602 CYMBALS, as above, special price **\$194.00**

No. 990PX—DELUXE CLASSIC OUTFIT, Choice of pearl finishes, WITH PAISTE CYMBALS listed above, special combination price **\$810.00**



LUDWIG BIG BEAT OUTFIT

Laying down the "big beat" is what this outfit was made for. It's built super-strong to take the super-drive of today's "rock" drummer. Outfit features the 5" x 14" SUPRAPHONIC "400" all-metal snare drum, 14" x 22" Bass Drum, 8" x 12" and 9" x 13" mounted Tom Toms, 16" x 16" Floor Tom Tom and the 201 Speed King Pedal. Positive sturdiness and strength come from the heavy duty ATLAS Drum Stand, BIG BEAT Hi-Hat Stand and two cymbal stands.

Psychedelic Red Pearl Illustrated

No. 989P—BIG BEAT OUTFIT. Choice of pearl finishes, chrome, WITHOUT CYMBALS **\$688.00**

Recommended PAISTE—Formula 602 CYMBALS for Big Beat Outfit: 2-14" Matched Hi-Hat, 1-18" Thin Crash, 1-20" Medium Ride.

No. 226—Set of 4 PAISTE-Formula 602 CYMBALS, as above, special price **\$194.00**

No. 989PX—BIG BEAT OUTFIT, Choice of pearl finishes, with PAISTE CYMBALS listed above, special combination price **\$882.00**

LUDWIG

the outfit choice of discriminating drummers



LUDWIG SUPER CLASSIC

The popular SUPER CLASSIC outfit offers superb design and built-in quality to meet every exacting demand. Outfit features Ludwig's popular 5" x 14" SUPRA-PHONIC "400" Snare Drum, 14" x 22" Bass stands, 9" x 13" mounted Tom Tom, 16" x 16" Floor Tom Tom. The finest in shell mount "positive locking" holders and Ludwig's new curved retracting spurs provide instant setup and years of dependable service. Modern flat base stands and the famous Ludwig Speed King pedal are standard. (Available with matching pearl snare drum at same price.)

No. 980P—SUPER CLASSIC OUTFIT, Choice of pearl finishes, chrome, WITHOUT CYMBALS. . . . \$566.00

No. 987P—SUPER CLASSIC OUTFIT, with 20" Bass drum, WITHOUT CYMBALS. . . . \$566.00

Recommended PAISTE-Formula 602 CYMBALS for Super Classic Outfit: 2—14" Matched Hi-Hat, 1—18" Thin Crash, 1—20" Medium Ride.

No. 226—Set of 4 PAISTE-Formula 602 CYMBALS, as above, special price. . . . \$194.00

No. 980PX—SUPER CLASSIC OUTFIT, Choice of pearl finishes, WITH PAISTE CYMBALS listed above, special combination price. . . . \$760.00

No. 987PX—SUPER CLASSIC OUTFIT, with 20" Bass drum and Cymbals. . . . \$760.00

White Marine Pearl Illustrated



LUDWIG HOLLYWOOD

Ludwig's "Twin" tom tom outfits have really captured the imagination of today's modern "Rock" drummers. The HOLLYWOOD features the new all-angle retracting double tom tom holder that provides complete angle and height adjustment for mixed tom tom sizes. The popular SUPRA-PHONIC "400" 5" x 14" metal snare drum, 14" x 22" Bass Drum, 8" x 12" and 9" x 13" mounted Tom Toms, 16" x 16" Floor Tom Tom, the famous 201 Speed King pedal and curved retracting spurs are standard.

No. 983-1P—HOLLYWOOD OUTFIT, Choice of pearl finishes, chrome, WITHOUT CYMBALS. **\$660.00**

Recommended PAISTE-Formula 602 CYMBALS for Hollywood Outfit: 2—14" Matched Hi-Hat, 1—18" Thin Crash, 1—20" Medium Ride.

No. 226—Set of 4 PAISTE-Formula 602 CYMBALS, as above, special price. **\$194.00**

No. 983-1PX—HOLLYWOOD OUTFIT, Choice of pearl finishes, WITH PAISTE CYMBALS listed above, special combination price. **\$854.00**

Sparkling Pink Champagne Pearl Illustrated

LUDWIG *...the ultimate in modern outfits*



LUDWIG BLUE NOTE

The outfit of all outfits, the BLUE NOTE provides the versatility to meet any demand any drummer can make. Ideal for the featured or soloist drummer, the outfit includes: 5" x 14" SUPRA-PHONIC "400" Snare Drum, 8" x 12" and 9" x 13" mounted Tom Toms, 16" x 16" and 16" x 18" floor Tom Toms, twin 14" x 22" Bass Drums, tunable bongos on stand, seat case and 2 Speed King 201 pedals plus many more accessories as illustrated.

Sparkling Blue Pearl Illustrated

No. 981-1P—BLUE NOTE OUTFIT. Choice of pearl finishes, chrome, WITHOUT CYMBALS. . . . \$1,172.00

Recommended PAISTE—Formula 602 CYMBALS for BLUE NOTE OUTFIT: 2-14" Matched Hi-Hat, 1-18" Thin Crash, 1-20" Medium Ride, 1-22" Thin Crash.

No. 227—Set of 5 PAISTE—Formula 602 CYMBALS, as above, special price. \$279.00

No. 981-1PX—BLUE NOTE OUTFIT. Choice of pearl finishes, WITH PAISTE CYMBALS, listed above, special combination price. \$1,451.00



LUDWIG ROCK DUO

"Rock" drummers have really taken to the ROCK DUO outfit, finding it has just the right drum combination to deliver the solid drive demanded by today's new music. Twin 14" x 20" Bass Drums provide the bottom beat with the SUPRA-PHONIC "400" Snare Drum, 8" x 12" and 9" x 13" mounted Tom Toms, and 16" x 16" Floor Tom Tom delivering the complementary rhythms. With 2 Speed King 201 pedals, stands and accessories.

Sparkling Silver Pearl Illustrated

No. 984PC—ROCK DUO OUTFIT. Choice of pearl finishes, chrome, WITHOUT CYMBALS. **\$836.00**

Recommended PAISTE—Formula 602 CYMBALS for ROCK DUO: 2-14" matched Hi-Hat, 1-18" Thin Crash, 1-20" Medium Ride.

No. 226—Set of 4 PAISTE—Formula 602 CYMBALS, as above, special price. **\$194.00**

No. 984PX—ROCK DUO OUTFIT, Choice of pearl finishes, WITH PAISTE CYMBALS listed above, special combination price. **\$1,030.00**

LUDWIG *...the beat behind today's musical pace*



LUDWIG PRO-BEAT

For the drummer who demands the absolute in his outfit, the PRO-BEAT offers a full range of sounds to provide the pulse for today's "aware" music. Outfit features the SUPRA-PHONIC "400" Snare Drum, 14" x 24" Bass Drum, 9" x 13" and 10" x 14" mounted Tom Toms, 16" x 16" and 16" x 18" Floor Tom Toms and 201 Speed King Pedal. Also featured are the ATLAS heavy-duty snare stand and cymbal floor stands, and BIG BEAT heavy-duty Hi-Hat Stand.

Oyster Blue Pearl Illustrated

No. 993P—PRO-BEAT OUTFIT, Choice of pearl finishes, chrome, WITHOUT CYMBALS. **\$850.00**

Recommended PAISTE—Formula 602 CYMBALS for Pro-Beat Outfit: 2-14" matched Hi-Hat, 1-18" Thin Crash, 1-20" Medium Ride.

No. 226—Set of 4 PAISTE—Formula 602 CYMBALS, as above, special price. **\$194.00**

No. 993PX—PRO-BEAT OUTFIT, Choice of pearl finish, WITH PAISTE CYMBALS listed above, special combination price. **\$1044.00**



LUDWIG CARIOCA

Inspired by the drummers of Brazil, the Carioca outfit features two timbales that can be used for adding new sound colors to your outfit. Featured are the SUPER-SENSITIVE "410" metal Snare Drum, 6½" x 13" and 6½" x 14" mounted chrome Timbales, 16" x 16" Floor Tom Tom, 14" x 22" Bass Drum, and the 201 Speed King Pedal. Also has ATLAS heavy-duty drum stand. BIG BEAT Hi-Hat stand, and two floor cymbal stands.

Panther Black Pearl Illustrated

No. 991P—CARIOCA OUTFIT, Choice of pearl finishes, chrome, WITHOUT CYMBALS..... **\$686.00**

Recommended PAISTE—Formula 602 Cymbals for Carioca Outfit: 2-14" matched Hi-Hat, 1-18" Thin Crash, 1-20" Medium Ride.

No. 226—Set of 4 PAISTE—Formula 602 CYMBALS, as above, special price..... **\$194.00**

No. 991PX—CARIOCA OUTFIT. Choice of pearl finishes, WITH PAISTE CYMBALS listed above, special combination price..... **\$880.00**



LUDWIG *the quality standard since 1909*



LUDWIG DOWNBEAT

The compactness of the DOWNBEAT makes it the ideal outfit for the progressive drummer playing "one-nighters". The 5" x 14" SUPRA-PHONIC "400" all-metal snare drum produces a crisp, clear brilliant sound and choke-free action at full volume. Also included is the sturdy 201 Speed King pedal, 8" x 12" and 14" x 14" Tom Toms, 14" x 20" Bass Drum with retracting spurs. All stands fold down for easy transport and are triple chrome plated.

Oyster Blue Pearl Illustrated

No. 988-1P—DOWNBEAT OUTFIT, Choice of pearl finishes, chrome, WITHOUT CYMBALS. **\$554.00**

Recommended PAISTE—Formula 602 CYMBALS for Downbeat Outfit: 2-14" Matched Hi-Hat, 1-18" Thin Crash, 1-20" Medium Ride.

No. 226—Set of 4 PAISTE—Formula 602 CYMBALS, as above, special price. **\$194.00**

No. 988-1PX—DOWNBEAT OUTFIT, Choice of pearl finishes, WITH PAISTE CYMBALS listed above, special combination price. **\$748.00**



LUDWIG JAZZETTE

Offering the striking combination of rich mahogany shells and sparkling chrome, the JAZZETTE also offers the combination of professional sound and dollar value. The famous SUPRA-PHONIC "400" snare drum sets the pace accompanied by a compact 12" x 18" Bass Drum, 8" x 12" and 14" x 14" Tom Toms and the durable 201 Speed King pedal. This is a four drum outfit that will well serve the most discriminating drummer. Available in mahogany, natural maple or lacquer finishes only. All stands and hardware are triple chrome plated.

Clear Lacquer Mahogany Illustrated

No. 995L—JAZZETTE OUTFIT, Choice of mahogany, maple or lacquer finishes, chrome,
WITHOUT CYMBALS **\$462.00**

Recommended PAISTE—Formula 602 CYMBALS for Jazzette Outfit: 2-14" Matched Hi-Hat, 1-18" Thin Crash, 1-20" Medium Ride.

No. 226—Set of 4 PAISTE—Formula 602 CYMBALS, as above, special price **\$194.00**

No. 995LX—JAZZETTE OUTFIT, Choice of mahogany, maple or lacquer finishes, WITH PAISTE CYMBALS listed above, special combination price **\$656.00**

LUDWIG

...the pace setter in low priced outfits



LUDWIG CLUB DATE

Compact, stylish and low priced makes the CLUB DATE outfit a leader! The popular all-metal 5" x 14" "Acrolite" Snare Drum provides the solid, reach-through voice needed for today's "big beat". Outfit also includes 14" x 20" Bass Drum, 8" x 12" and 14" x 14" Tom Toms, 5" cowbell and holder, flat base drum stand, Speedmaster pedal, cymbal holder and disappearing spurs are also standard. All hardware triple chrome plated.

No. 996-1L—CLUB DATE OUTFIT, Choice of lacquer finishes, chrome, WITHOUT CYMBAL \$382.00

No. 996-1P—CLUB DATE OUTFIT, Choice of pearl finishes, chrome, WITHOUT CYMBAL \$443.00

Recommended LUDWIG-STANDARD CYMBAL for Club Date Outfit: 1-19" Medium Ride.

No. 219-MR—19" Medium Ride Cymbal \$39.00

No. 996-1LX—CLUB DATE OUTFIT, Choice of lacquer finishes, WITH LUDWIG CYMBAL listed above, special combination price \$421.00

No. 996-1PX—CLUB DATE OUTFIT, Choice of pearl finishes, WITH LUDWIG CYMBAL listed above, special combination price \$482.00

Sparkling Red Pearl Illustrated

LUDWIG

SPEED KING PEDAL



The "King" of all pedals, years of constant improvement have made the SPEED KING the most desirable pedal available anywhere today. Only the SPEED KING has precision die-cast stand, footboard, rocker shaft and heel plate. It is also the ONLY pedal to feature twin compression springs completely enclosed in the pedal posts. Protected dual ball bearings in a lifetime lubricant, provide the fastest pedal action possible. Tension is adjustable and arched rocker shaft offers the leverage needed for ideal stability and balance. Rubber mat fitted to the footboard prevents skidding; heavy-duty linkage withstands the heaviest foot pressure. Over 30 years of continual improvement have made the SPEED KING by far the "professional" pedal.

**No. 201—SPEED KING
PEDAL.....\$30.00**

- Twin Ball Bearings
- Twin Compression Springs
- Unbreakable Steel Toe Clamp
- Fast, Positive Tension Adjustment
- Non-Skid Rubber Base Mounting
- Exclusive Reversible Heel Plate

Exclusive reversible heel plate "flips" instantly to provide one or two piece footboard.

Springs compress rather than stretch, so each stroke of action gets stronger and faster.

Spring tension is adjustable with screwdriver from bottom of pedal.

LUDWIG *quality stands and stools*



1. Sure-grip heel Spur Lock
2. Positive DIRECT-PULL assembly
3. Floor leveler leg suspension

DURABLE "CLASSIC" LINE

The Ludwig "CLASSIC" line of fine quality stands and stool offers the drum world the greatest value available. Sturdy all steel construction with glistening chrome finish provides exceptional strength, long lasting durability and outstanding service. The 1123-1 "Direct Pull" hi-hat features floor leveler leg suspension, all metal bottom cymbal seat with built-in angle adjustment and the "sure-grip" *Spur Lock* heel assembly. The compact "Porto Seat" with oval, black vinyl covered seat offers dependable support and greater portability and compactness.

- No. 1400 — FLAT BASE CYMBAL STAND, folds to 22" . . \$14.50
- No. 1123-1 — DIRECT PULL HI-HAT, folds to 20" \$28.00
- No. 1363 — FLAT BASE SNARE DRUM STAND, folds to 20" . . \$16.00
- No. 1025-1 — PORTO SEAT with Oval Black Vinyl Seat \$22.00



HEAVY DUTY "ATLAS" LINE

Ludwig's new ATLAS line of stands and stool are especially designed and built to withstand the rugged demands of today's drummers. The "heavy duty" construction can really take it yet each stand folds to compactly fit a standard trap case. The BIG BEAT Hi-Hat features DIRECT-PULL action with variable spring tension adjustment knob, both toe and heel spurs to hold the stand in place and height and angle adjustment of cymbals. The heavy duty ATLAS drum stand securely locks drum at any desired angle or height. The new ATLAS cymbal stand offers wide angle tripod base that can handle extremely large cymbals. The sturdy DRUM and TIMPANI stool has a round padded black vinyl covered seat.

- No. 1402 —ATLAS CYMBAL STAND \$24.00
- No. 1124 —ATLAS "BIG-BEAT" HI-HAT \$40.00
- No. 1364-5 —ATLAS DRUM STAND. (Dance Model) \$28.00
- No. 1364-6 —ATLAS DRUM STAND (Concert Model) with 6" insert extension tube \$30.00
- No. 1369 —EXTENSION TUBE only for Atlas Drum Stand. . \$ 3.50
- No. 1026-1 —DRUM AND TIMPANI STOOL with Round Black Vinyl Seat. . . . \$25.00

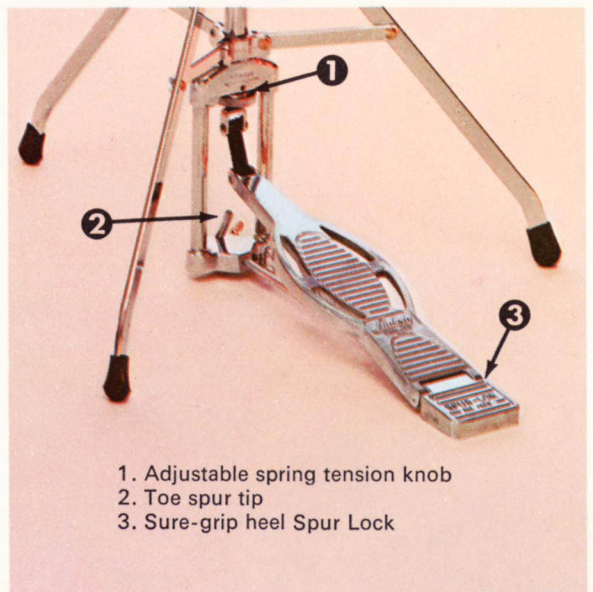

- 1. Adjustable spring tension knob
- 2. Toe spur tip
- 3. Sure-grip heel Spur Lock

LUDWIG

snare drum stands



1354

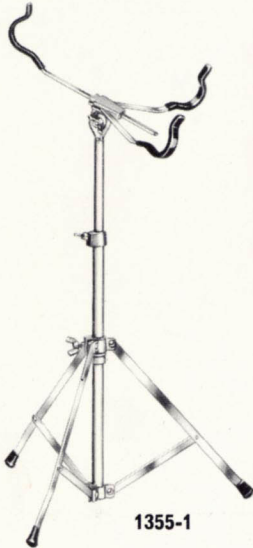

1355-1

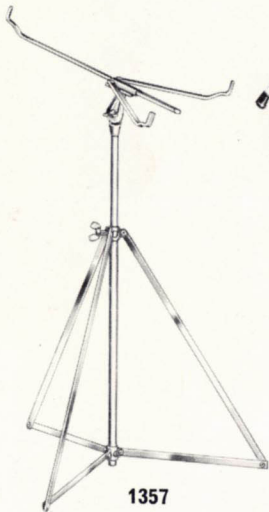

1357

Ludwig offers a variety of sturdy, durable snare drum stands to fit every need. Precision-engineered construction provides best performance with maximum compactness for portability and convenience. All stands are chrome plated except No. 1354 base; all have complete height and angle adjustment.

No. 1354—DELUXE CONCERT STAND, heavy duty with black enamel finish base and lower tube. . . . \$22.00

No. 1355-1—MICROMATIC SCHOOL DRUM STAND wide-angle tripod base. . . . 16.00

No. 1357—JUNIOR DRUM STAND, sturdy yet lightweight and compact. . . . 12.50

LUDWIG quality pedals

UNIVERSAL SPEEDMASTER

The "UNIVERSAL" SPEEDMASTER pedal is the result of many years of refinements and improvements of the original floor toe pedal, which was invented by Wm. F. Ludwig in 1909. Through the many years of modernization, the "UNIVERSAL" has become one of the most popular pedals at its price. Modern ball-bearing action along with a solid one-piece unbreakable foot-board, fully adjustable spring for desired tension, "free-floating" leather connecting strap, sturdy Ludwig construction and precision-balanced design make the "UNIVERSAL" SPEEDMASTER one of the finest pedals for the modern drummer.

No. 252—UNIVERSAL SPEEDMASTER . . \$23.00



LUDWIG JUNIOR PEDAL

Here is fine quality performance at an economical price! The JUNIOR model is designed to provide fast, smooth, perfect action. Modern nylon bushings and precision-mounted one-piece cast footboard assure immediate pedal response; complete spring tension adjustment allows the drummer to enjoy desired, easy pedal action. Due to Ludwig's quality construction and design, the JUNIOR pedal offers long-lasting performance and satisfaction at a budget price.

No. 207—LUDWIG JUNIOR PEDAL \$16.50





LUDWIG

SUPRA-PHONIC 400
with Acousti-Perfect shell design

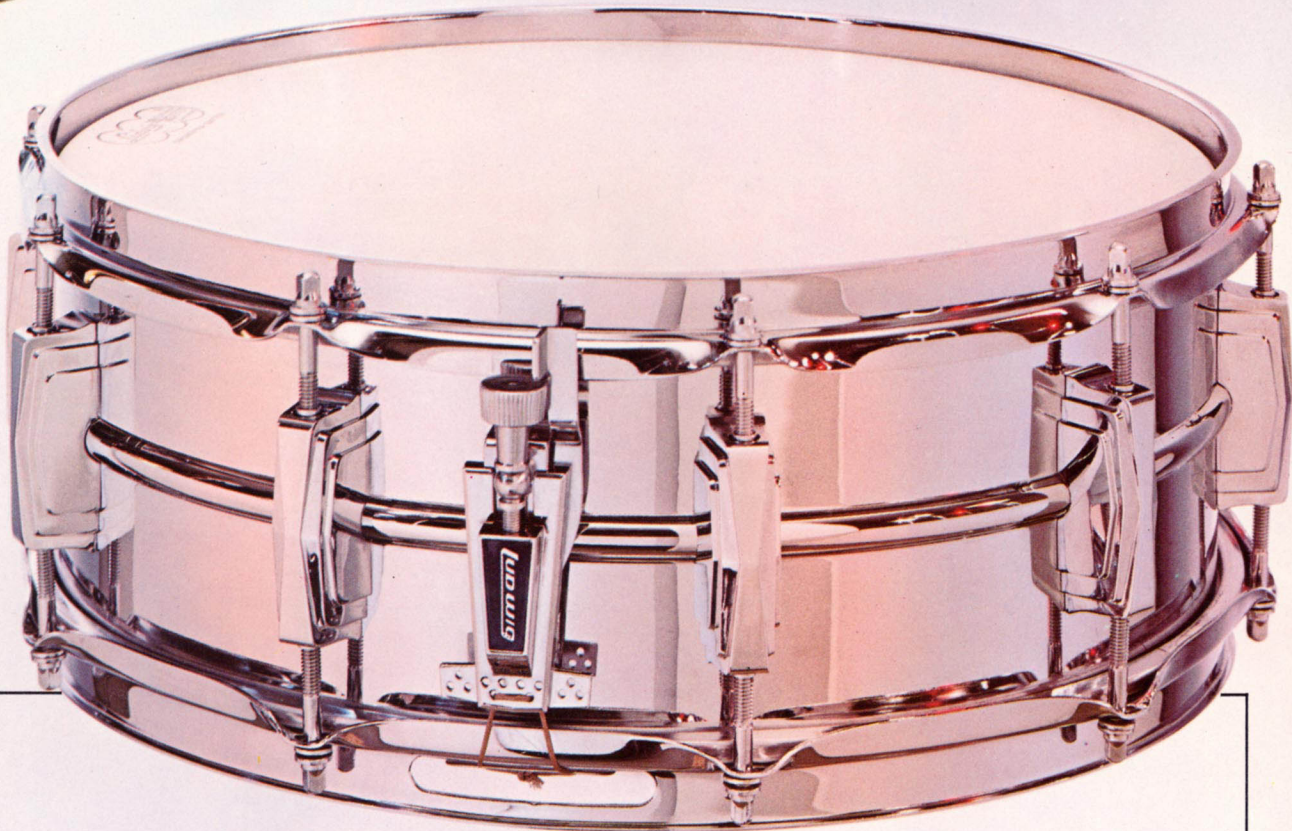

Ludwig's SUPRA-PHONIC 400 all-metal snare drums have long been the world's most popular drum, outselling all other makes and models.

Drummers get the six features they want most: Instant response over the entire drum head. Vivid tonal definition, each beat crisp and clear. Brilliant sound, choke-free at full volume. Full power without distortion. Full projection at all dynamics. Increased stick rebound for faster action with less effort.

The SUPRA-PHONIC all-metal snare drums are constructed with a one-piece ACOUSTI-PERFECT seamless shell, beaded in the center and flanged at the edges for triple strength.

Ten self-aligning tension casings provide extra fine head adjustment. The new P-85 snare strainer gives complete and instant snare control with full drop of snares. Triple-flanged hoops assure a solid rim shot every time.

You hear the difference, feel the difference in this superior drum. Try it! Offered in two popular sizes: 5" x 14" and 6½" x 14" and as standard equipment with all popular Ludwig outfits. Supplied with Ludwig WEATHER MASTER plastic heads and with 18 strand, wire snares.

No. 400—5" x 14" SUPRA-PHONIC SNARE DRUM, chrome..... \$106.00

No. 402—6½" x 14" SUPRA-PHONIC SNARE DRUM, chrome..... 110.00

LUDWIG SUPER-SENSITIVE

with Acousti-Perfect shell design



Here is something *tonally different* in drums; finer than ever in sound and feel! The reason is the ACOUSTI-PERFECT seamless all-metal shell and especially crafted plastic heads, snares and new snare strainer developed by Ludwig.

Finest of drums, the SUPER-SENSITIVE has more exclusive features than any other. Snares extend across the entire surface of the snare head, providing full diameter snare vibration and sensitive response from the edge to the center of the drum. The new dual snare strainer provides for parallel snare release, operated by a single control lever. (Snares are kept under consistent, even tension when released away from the head.) The new snare strainer keeps the snares under even pressure-contact against the head.

The SUPER-SENSITIVE is the only drum available with eight different combinations of snare units, changeable in seconds for jazz, rock, symphonic band, orchestral or military drumming to meet the demands of the music being performed.

The beaded, perfectly round, seamless all-metal shell is triple chrome plated. Ten, self-aligning tension casings allow for maximum tonal transfer from batter to snare head and for minute tension adjustments.

Available in two popular sizes: 5" x 14" and 6½" x 14". A special screw-driver drum key is supplied with every drum. Each drum is mounted with specially designed plastic heads and 24-strand non-adjustable wire snares (triple swivel mounted), unless otherwise specified. A specially designed fibre carrying case or Dura-Hyde cover is available at additional cost.

- | | | |
|------------------|------------------------------------------------------------------|-----------------|
| No. 410 | —5" x 14" Super-Sensitive, chrome..... | \$160.00 |
| No. 411 | —6½" x 14" Super-Sensitive, chrome..... | 164.00 |
| No. P-40 | —Super-Sensitive Screw Driver Drum Key..... | 1.00 |
| No. 172-1 | —5" x 14" Special Dura-Hyde Cover for Super-Sensitive Drum..... | 16.50 |
| No. 173-1 | —6½" x 14" Special Dura-Hyde Cover for Super-Sensitive Drum..... | 16.50 |
| No. 7154 | —14" Square Vulcanized Fibre Case for Super-Sensitive Drum..... | 19.50 |



A



B



C

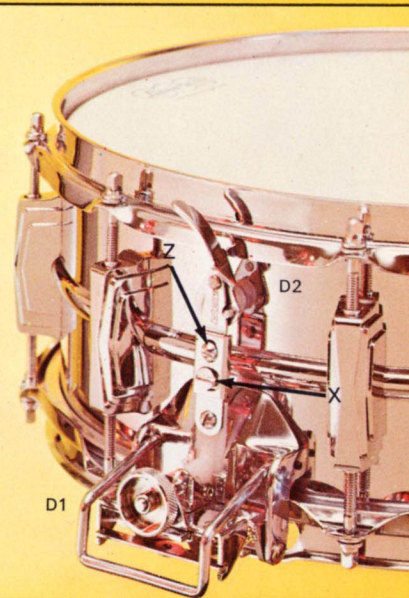

D1

D2

X

Z

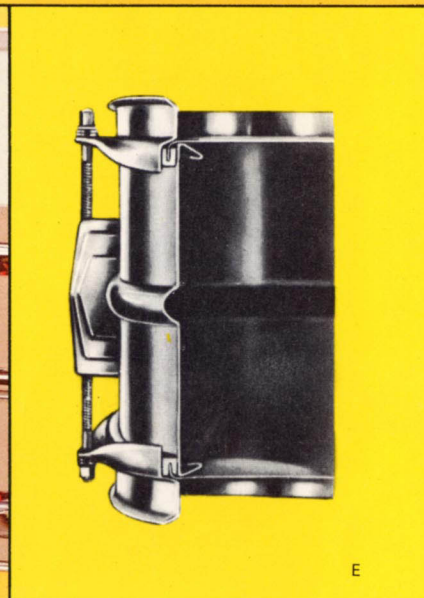

E

A QUICK CHANGE SNARE UNIT

You can change to your choice of eight different snare units in a matter of seconds. Each unit is complete with snares, swivel mounts and retainer ends.

B DUAL SNARE RELEASE WITH FULLY EXTENDED SNARES

Two complete mechanisms, operated by a single control lever, permit the drummer to release fully extended snares under uniform tension away from, and returned to, the snare head. Original snare adjustment never varies.

C INDIVIDUAL SNARE ADJUSTED UNITS

All eight snare units, with the exception of the 18 and 24-strand wire units, feature individual snare strand adjustment—assuring perfectly balanced snare action.

D1 DOUBLE SNARE TENSIONING—HORIZONTAL

All snare units are tensioned from both sides of the shell by the diamond knurled wheel screw located in each mechanism attached to the shell.

D2 DOUBLE SNARE TENSIONING—VERTICAL

Additional refined adjustments, for the desired amount of snare pressure-contact against the snare head, can be made with the height adjustment screw (Z) or the eccentric screw (X). These screws are located on the connecting link of each mechanism.

E ALL-METAL SEAMLESS SHELL

The only one-piece seamless shell, precision formed of heavy gauge metal with flanged edges and center bead for triple strength. (Only a seamless metal shell is perfectly round.)

F SNARE UNITS

Eight different snare units are available, which snap into place within seconds. (18 and 24-wire strand units feature self-aligning swivel mounts.)

- | | |
|-------------------------------------------------------------------------------------|-----------|
| No. 1220—24 Strand Wire, triple swivel mounted, not individually adjusted | } \$15.00 |
| No. 1221—15 Strand Wire, individually adjusted | |
| No. 1222—9 Strand Wire, 6 Gut, individually adjusted | |
| No. 1223—15 Strand Gut, individually adjusted | |
| No. 1224—18 Strand Wire, swivel mounted, not individually adjusted | |
| No. 1225—10 Strand Wire, individually adjusted | |
| No. 1226—6 Strand Wire, 4 Gut, individually adjusted | |
| No. 1227—10 Strand Gut, individually adjusted | |

Nylon comb. are available upon request. When ordering any of the above snare units, specify that the unit(s) is for a 14" diameter drum.

LUDWIG

experience/imagination/craftsmanship



**ACROLITE
SNARE DRUM**



SUPER CLASSIC MODEL

ACROLITE SNARE DRUM

ACROLITE . . . lightens the drum, brightens the tone! Exciting advances in drum design and construction provide the first all-metal snare drum at a low price. Ludwig's wonder metal ACROLITE makes possible a lightweight drum with resonance and tone found only in more expensive models. The ACROLITE drum features Ludwig's ACOUSTI-PERFECT shell design, the famous one piece "beaded" metal shell, 8 self-aligning tension casings and triple-flanged hoops. Hoops and tension casings are bright finished. Supplied with the new Ludwig WEATHER MASTER plastic heads and 20 strand wire snares.

No. 404—5" x 14" ACROLITE SNARE DRUM . . \$78.00

SUPER CLASSIC MODEL

THE SUPER CLASSIC MODEL . . . unsurpassed quality in tone and design! Advanced, modern design and traditional Ludwig quality construction has made this model the choice of professionals from coast to coast. Sturdy laminated shell blends genuine African mahogany with select maple panels and is reinforced with rock-maple glue rings to provide the strongest shell possible. Exclusive ACOUSTI-PERFECT design and hot clear lacquer spray inside shell provide exceptional tone, resonance and response from a wood shell drum. Featuring the Classic throw-off, streamlined self-aligning tension casings, the original triple-flanged hoops and matched heads, the SUPER CLASSIC is truly an instrument of unsurpassed quality. Supplied with the new Ludwig WEATHER MASTER plastic heads and 18 strand wire snares.

No. 900L—5" x 14" Choice of Lacquer finishes . \$ 96.50

No. 900P—5" x 14" Choice of Pearl finishes . . . 110.00



JAZZ FESTIVAL MODEL



PIONEER MODEL



JAZZ FESTIVAL MODEL

Instant, crisp response and undistorted snare action are provided in this popular 5" x 14" model featuring Ludwig's ACOUSTI-PERFECT shell design. Inside of shell is finished with Ludwig's exclusive hot lacquer spray for greater resonance and tonal body. The new P-85 throw-off offers instant trouble-free snare control. Supplied with 8 gleaming self-aligning tension casings, the original triple-flanged hoops and matched THIN heads. All metal parts are highly polished and plated to a glistening lustre for years of lasting beauty. Supplied with the new Ludwig WEATHER MASTER plastic heads and 18 strand wire snares.

- No. 908L**—5" x 14" Choice of Lacquer finishes... **\$86.00**
- No. 908P**—5" x 14" Choice of Pearl finishes... **96.00**

PIONEER MODEL

Here is the leader in the low-priced field available in two popular sizes: 5" x 14" and 6½" x 14". The PIONEER features Ludwig's sturdy laminated shell reinforced with rock-maple glue rings and finished inside with an exclusive hot clear lacquer spray, six self-aligning tension casings, triple-flanged hoops and the new P-85 throw-off. ACOUSTI-PERFECT shell design provides superior tone and response found in more expensive models. Here is true value in a student line instrument. Supplied with the new Ludwig WEATHER MASTER plastic heads and 12 strand wire snares.

- No. 491L**—5" x 14" Mahogany or
Lacquer finishes **\$64.50**
- No. 490L**—6½" x 14" Mahogany or
Lacquer finishes **69.00**
- No. 491P**—5" x 14" Choice of Pearl finishes... **76.50**
- No. 490P**—6½" x 14" Choice of Pearl finishes ... **81.00**

LUDWIG *concert snare drums*

SCHOOL FESTIVAL MODEL

The FESTIVAL is a quality concert drum designed especially for the school band and orchestra. Ludwig's exclusive LUD-COTE interior delivers a true classic tone. Sturdy laminated shell with rock maple glue-rings, 16 self-aligning tension casings and hard-chrome finished hardware guarantee this as a drum that will last. In pearl, lacquer or mahogany finishes, plastic heads.

No. 912—6½" x 14" (M) Mahogany or
(L) Lacquer finishes \$91.00

No. 914—6½" x 15" (M) Mahogany or
(L) Lacquer finishes 93.00
Pearl finishes extra 12.00



SYMPHONIC MODEL

Designed for the full, traditional concert tone, the SYMPHONIC has a deep 6½" x 14" ACOUSTI-PERFECT wood shell. This, along with the positive CLASSIC throw-off and 18 strand wire snare unit make this model the most artistic band and concert drum available. Inner shell has Ludwig's exclusive LUD-COTE for even greater resonance and response. All chrome Hardware, plastic heads.

No. 902L—6½" x 14" Choice of lacquer finishes . . . \$102.00

No. 902P—6½" x 14" Choice of pearl finishes 114.00



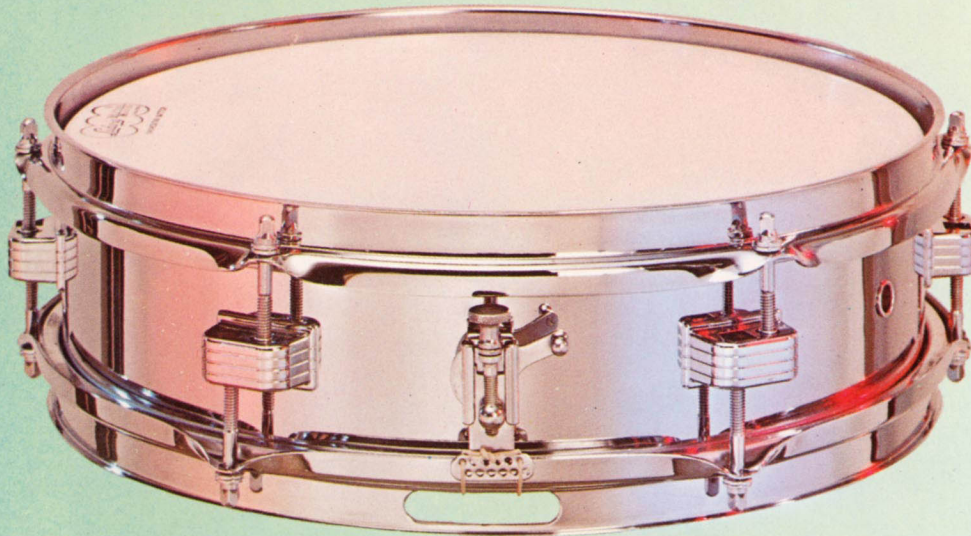

PICCOLO SNARE DRUM

Presenting the PICCOLO snare drum, a new solo "soprano" percussion voice ideal for today's intricate, rhythmic patterns. The all-metal 3" x 13" shell produces the crisp sound demanded by so many of today's top recording percussionists. Special, separate tension casings allow extra sensitive tuning. Quick action "Pioneer" throw-off; triple-chrome hardware; plastic heads. A must for the truly serious drummer.

No. 405—3" x 13" Piccolo Snare Drum **\$92.00**

AUDITORIUM MODEL

Though moderately priced, the AUDITORIUM model delivers an amazingly true and rich concert tone. The shell features the exclusive ACOUSTI-PERFECT shell with interior finished with LUD-COTE for added resonance and response. *Original* triple-flanged hoops, new P-85 snare throw-off and 8 self-aligning tension casings, all triple chrome finished. In pearl, lacquer, or mahogany finishes, plastic heads.

No. 470—6½" x 14" Mahogany or Lacquer **\$82.00**

No. 471—6½" x 15" Mahogany or Lacquer **86.00**

Pearl finishes, extra **12.00**

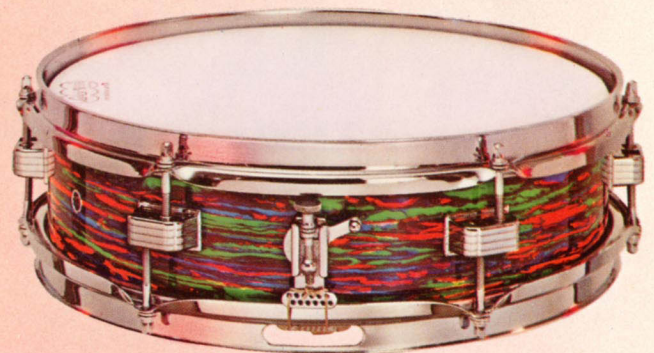

JAZZ COMBO MODEL

For the traveling drummer, the DOWNBEAT offers the advantage of a narrow shell plus the added volume and tone a 14" diameter delivers. Eight tension casings, "Pioneer" throw-off, plastic heads.

No.906L —4" x 14" Mahogany or Lacquer **\$78.00**

No.906P —4" x 14" Choice of pearl finishes **88.00**

DOWNBEAT MODEL (not shown)

A favorite with the small combo and studio drummer, the 3" x 13" model gives the crisp, high-pitched sounds so popular in today's "pop" fields. 6 special tension casings for extra sensitive tuning, plastic heads.

No. 905L—Choice of Lacquer finishes **\$63.50**

No. 905P—Choice of Pearl finishes **72.50**



MODERN SNARE DRUM QUARTET

Ludwig now offers four all-metal snare drums in four separate voicings as part of its Total Percussion Concept . . . a concept that makes every percussion section "performance perfect" and complete. The crisp, live solo "Soprano" voice of the 3" x 13" PICCOLO; the tonally different "Alto" and "Tenor" voices of the versatile 5" x 14" and 6½" x 14" SUPER-SENSITIVE drums for jazz, rock and symphonic performances; the "Baritone" voice of the 12" x 15" SUPER-SENSITIVE PARADE drum for marches, special effects and reinforcement of basic drum parts. Here are four snare drums essential for performing the music of yesterday, today and tomorrow!



No. 397—MODERN SNARE DRUM QUARTET,
illustrated (stands not included) \$550.00

CONCERT TOM TOMS

Ludwig's CONCERT TOM TOMS are designed especially to meet the many demands of the music being written for today's orchestras, bands and ensembles. Mounted on adjustable chrome plated stands, as illustrated, Ludwig offers two sets of 4 graduated, single head, tunable CONCERT TOMS. Available in choice of lacquer or pearl finishes.

Sizes in the set of 4 *high* pitched toms are: 5½" x 6", 5½" x 8", 6½" x 10" and 8" x 12". Sizes in the set of 4 *low* pitched toms are: 9" x 13", 10" x 14", 12" x 15" and 14" x 16". Each set of 4 toms nest inside one another for easy packing in a single fibre case; cases extra. Sold complete as listed; however, items may be purchased separately.



445
Fits case No. 8567
See Page 101



443
Fits case No. 8362
See Page 101

- No. 443L—CONCERT TOM TOMS (High Pitch), Choice of Lacquer finishes, complete with clip attachments and stands, illustrated **\$180.00**
 No. 443P—CONCERT TOM TOMS (High Pitch), Choice of Pearl finishes, complete with clip attachments and stands **200.00**
 No. 445L—CONCERT TOM TOMS (Low Pitch), Choice of Lacquer finishes, complete with clip attachments and stands, illustrated **247.00**
 No. 445P—CONCERT TOM TOMS (Low Pitch), Choice of Pearl finishes, complete with clip attachments and stands **300.00**
 No. 1343—Concert Tom Floor Stand only (holds two toms) **16.00**

| HIGH PITCHED TOM SET: | | LOW PITCHED TOM SET: | | | |
|-----------------------|-----------------|----------------------|---------------------|-----------------|-----------------|
| | Lacquer | Pearl | | | |
| 1 No. 487—5½" x 6" | \$33.00 | \$36.00 | 1 No. 462—9" x 13" | \$50.00 | \$60.00 |
| 1 No. 488—5½" x 8" | 34.00 | 37.00 | 1 No. 463—10" x 14" | 54.00 | 65.00 |
| 1 No. 489—6½" x 10" | 43.50 | 50.00 | 1 No. 464—12" x 15" | 58.00 | 75.00 |
| 1 No. 461—8" x 12" | 47.50 | 55.00 | 1 No. 465—14" x 16" | 66.00 | 85.00 |
| 2 No. 1343 Stand | 32.00 | 32.00 | 2 No. 1343 Stand | 32.00 | 32.00 |
| TOTAL VALUE | \$190.00 | \$210.00 | TOTAL VALUE | \$260.00 | \$317.00 |

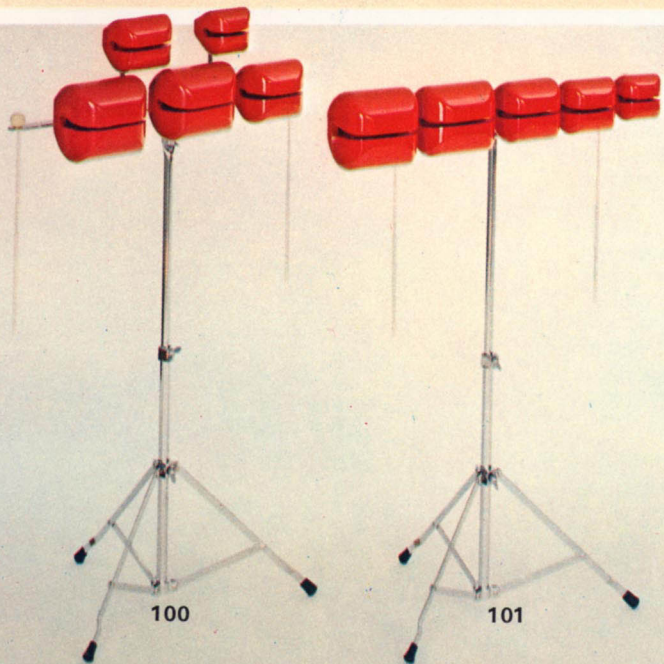

100

101

CONCERT TEMPLE BLOCKS:

Ludwig now offers two separate sets of 5 graduated CONCERT TEMPLE BLOCKS, finished in bright red lacquer and mounted on your choice of chrome plated stand with staggered or "in-line" arms as illustrated. Sold complete as listed; however, items may be purchased separately. Supplied with one pair of suitable mallets.

- No. 100 —CONCERT TEMPLE BLOCKS and stand with staggered arms, illustrated **\$80.00**
 No. 101 —CONCERT TEMPLE BLOCKS and stand with "in-line" arms, illustrated **78.00**
 No. 1347—Temple Block Stand with staggered arms **25.00**
 No. 1342—Temple Block Stand with "in-line" arms **23.00**
 No. 80 —Set of 5 Temple Blocks with mallets **55.00**
 No. M 1 —Mallets, pair **3.85**

INDIVIDUAL TEMPLE BLOCKS:

- No. 691—5" **\$13.50**
 No. 692—4½" **12.50**
 No. 693—4" **11.50**
 No. 694—3½" **10.50**
 No. 695—3" **9.50**

LUDWIG

...a modern concept in percussion education



JUNIOR PERCUSSIONIST KIT

Ludwig's JUNIOR PERCUSSIONIST KIT is an entirely new approach to percussion education which introduces the beginning student to "total percussion" by developing melodic and rhythmic concepts, along with aural and visual concepts. Combining a 2½ octave set of chromatic steel bells with a heavy duty metal practice pad and stand, the JUNIOR PERCUSSIONIST KIT provides the means by which the student will learn manipulative and reading skills.

Carefully tuned to A-440, buffed and plated steel bells are mounted on a wooden frame which rests upon a moulded insert in a handsome carrying case with removable lid. A pair of double end bell mallets and a pair of suitable drum sticks are included in the kit, along with selected study material.

The use of the Ludwig JUNIOR PERCUSSIONIST KIT will result in a more logical progress for a student to truly become a percussionist.

No. M-649 JUNIOR PERCUSSIONIST KIT,
complete (G⁵-C⁸) with 355 Heavy Duty
Metal Practice Pad..... **\$80.00**

No. M-650 JUNIOR PERCUSSIONIST KIT,
with No. 359 8" Tunable Practice Pad..... **\$84.50**





LUDWIG PERFORMANCE-PRACTICE DUO

Ludwig combines its STANDARD ACROLITE KIT and JUNIOR PERCUSSIONIST KIT to provide another concept in basic learning of percussion. Ideal for performing and practicing the study of rhythmic and melodic patterns, technique and reading skills.

No. 2455—PERFORMANCE-PRACTICE DUO, complete..... \$196.00

Duo includes:

No. 2444-1 STANDARD ACROLITE DRUM KIT, complete..... \$116.00

No. M-649—JUNIOR PERCUSSIONIST KIT, complete..... \$80.00

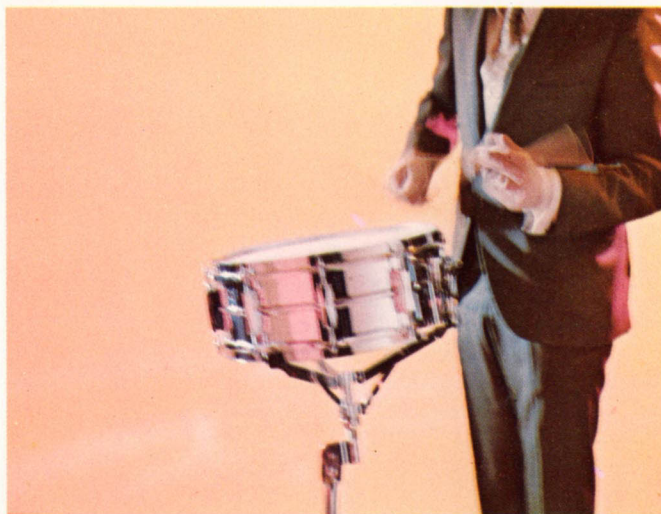

LUDWIG

CONTOURA DRUM KITS



STANDARD CONTOURA KIT

The STANDARD CONTOURA KIT features the popular No. "404" 5" x 14" ACROLITE snare drum, the dependable Micromatic stand, the molded No. 8030 unlined Contoura case, Gladstone practice pad, a pair of sticks, and method book. Ideal for the beginning student drummer, the STANDARD CONTOURA KIT offers professional sound, dependability and economy.

No. 2444-1—STANDARD CONTOURA KIT,
complete.....\$116.00

PIONEER CONTOURA KIT

The PIONEER CONTOURA KIT offers real value to the beginning drummer and includes; the handsome wood shell 6 lug PIONEER model snare drum in your choice of pearl finishes, the Micromatic snare stand, No. 8030 unlined Contoura case, No. 354 Porto-Pad, sticks and method book.

No. 2458—PIONEER CONTOURA KIT,
complete.....\$112.00

LUDWIG "CONTOURA" DRUM KIT CASE

The seamless "CONTOURA" drum kit was developed and perfected by Ludwig Drum Co. to provide maximum protection for the drum and accessories. Molded of durable, high impact, textured acrylic, the lightweight "CONTOURA" is available in three interior finishes: unlined, blue felt-lined or red plush-lined. Drum fits comfortably into top of case; separate bottom compartment holds all accessories.

See page 102 for listing



SUPER DELUXE CONTOURA KIT

Ludwig combines the excellent qualities of the SUPRAPHONIC "400" 5" x 14" snare drum and the Micromatic stand with the deluxe red plush-lined "CONTOURA" molded case to offer the finest quality drum kit available. Light in portable weight and complete with a pair of suitable snare drum sticks, Gladstone practice pad and method book, the SUPER DELUXE CONTOURA KIT provides the student drummer with the finest available.

**No. 2441-1—SUPER DELUXE CONTOURA
KIT, complete.....\$158.00**

DELUXE CONTOURA KIT

The DELUXE CONTOURA KIT features the all-metal ACROLITE 5" x 14" snare drum in a "CONTOURA" molded case, lined in royal-blue felt. The kit is complete with sturdy Micromatic stand, famous Gladstone practice pad, a suitable pair of sticks and method book—everything for the beginning student at a moderate price.

**No. 2443-1—DELUXE CONTOURA KIT,
complete.....\$128.00**

LUDWIG *quality drum kits*



JUNIOR CONCERT KIT

The JUNIOR CONCERT KIT offers the beginning drummer economy and service in his first drum. Supplied with 5" x 14" Pioneer concert snare drum in a choice of lacquer or mahogany finishes, folding stand, practice pad, sticks and drum method. All items fit compactly into handsome, lightweight luggage type case for protection and easy carrying. The JUNIOR CONCERT KIT is an outstanding value in the low-price field.

No. 2445— JUNIOR CONCERT KIT, complete. \$90.00

SPOTLIGHT CONCERT KIT

The SPOTLIGHT CONCERT KIT contains everything for the student drummer in a handsome lightweight fibre case. The 5" x 14" six rod concert snare drum features the new P-85 strainer and throw-off to offer the finest control on any snare drum in its price range. Available in a wide choice of pearl finishes, the snare drum with flat base stand, rubber practice pad, sticks and drum method fit compactly into the case for easy portability.

**No. 2447—SPOTLIGHT CONCERT KIT,
complete \$106.00**



MASTER CONCERT KIT

The MASTER CONCERT KIT features the lightweight, all-metal 5" x 14" ACROLITE snare drum with the new P-85 snare strainer and throw-off. This quality snare drum, with one piece seamless beaded shell, offers the tonal quality normally found in much higher priced drums. Supplied complete with Micromatic stand, rubber practice pad, a pair of suitable sticks and method book . . . all protected in a special case for durability and long service.

No. 2448—MASTER CONCERT KIT,
complete \$109.00



JUNIOR MARCHING KIT

Here is the ideal marching kit for the young drummer just starting his studies. Complete kit includes 10" x 14" single tension parade drum in a choice of lacquer or mahogany finishes, sticks, sling and handsome fibre case for extra protection. Matched plastic heads and the new P-85 snare throw-off make this drum a quality leader in the low-price field.

No. 2446—JUNIOR MARCHING KIT,
complete \$65.50

LUDWIG TOM

instruments of superior tone

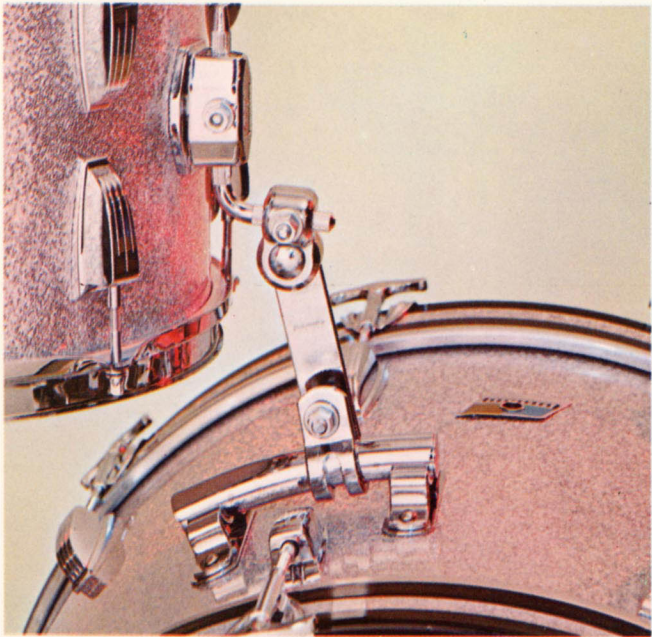

No. 944P— 9" x 13"

TOM TOM SHELL MOUNT HOLDERS

Ludwig's shell mount tom tom holders feature die cast ratchet adjustments and splined angle bars, providing fine angle and positive locking adjustments. Both holders offer complete height and angle adjustments, to offer the most solid tom tom mountings available. The retracting 781-2 holder is mounted in the center of the bass drum for ideal playing position.

- No. 782-1**—Single Tom Tom Holder,
complete **\$14.50**
No. 781-2—Double Tom Tom Holder,
complete **23.00**

SUPER CLASSIC TOM TOMS

Super Classic tom toms are fashioned with the same care and attention to detail as all other Ludwig instruments. The sturdy but lightweight laminated shells are a blend of select African mahogany with poplar core, reinforced with rings of solid rock-maple.

Ludwig's original triple-flanged hoops and twin "Classic" tension casings are standard on all sizes. Specify your choice of pearl or lacquer finish when ordering. All models supplied with triple chrome-plated hardware. All floor model tom toms are supplied with 17" legs mounted as standard equipment at no additional cost. (23" long legs available at no extra charge.)

- No. 942L**—8" x 12" Choice of Lacquer finishes . . . **\$72.50**
No. 942P—8" x 12" Choice of Pearl finishes **82.00**
No. 944L—9" x 13" Choice of Lacquer finishes . . . **75.00**
No. 944P—9" x 13" Choice of Pearl finishes **84.00**
Holders mounted on above models—extra. Specify your choice when ordering.

TOMS

and resonance



No. 950P—16" x 16"
(No. 5022 Legs Included)

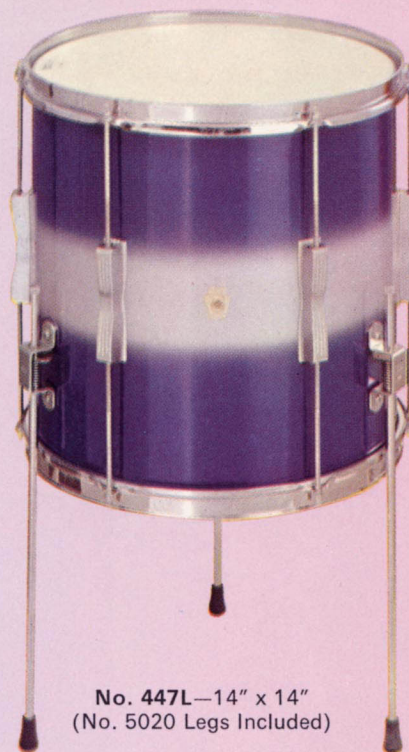

No. 447L—14" x 14"
(No. 5020 Legs Included)



No. 444L— 9" x 13"

- No. 948L—14" x 14"** Choice of Lacquer finishes,
legs mounted \$ **94.50**
- No. 948P—14" x 14"** Choice of Pearl finishes,
legs mounted **112.00**
- No. 950L—16" x 16"** Choice of Lacquer finishes,
legs mounted **104.00**
- No. 950P—16" x 16"** Choice of Pearl finishes,
legs mounted **123.00**
- No. 952L—16" x 18"** Choice of Lacquer finishes,
legs mounted **124.00**
- No. 952P—16" x 18"** Choice of Pearl finishes,
legs mounted **140.00**
- No. 954L—18" x 20"** Choice of Lacquer finishes,
legs mounted **138.50**
- No. 954P—18" x 20"** Choice of Pearl finishes,
legs mounted **163.50**

CLUB DATE TOM TOMS

A quality low price line of separate tension tom toms featuring center row self-aligning tension casings, triple-flanged hoops and matched heads. Holders extra at slight additional cost. The 14" x 14" model includes legs mounted as standard equipment.

- No. 442L— 8" x 12"** Choice of Lacquer finishes . . . **\$60.00**
- No. 442P— 8" x 12"** Choice of Pearl finishes **69.00**
- No. 444L— 9" x 13"** Choice of Lacquer finishes . . . **63.50**
- No. 444P— 9" x 13"** Choice of Pearl finishes **72.00**
- No. 447L—14" x 14"** Choice of Lacquer finishes . . . **77.50**
- No. 447P—14" x 14"** Choice of Pearl finishes **99.00**

Not available in 16" x 16" size.

LUDWIG bass drums

LUDWIG CLASSIC

Here is the top quality line in bass drums featuring 20 large twin "Classic" self-aligning tension casings, matching form-fitting T-handles and double claw hooks providing even tension over entire head surface. Available in all popular sizes with your choice of pearl, lacquer color or natural lacquer finishes and triple chrome-plated hardware. Pearl inlaid hoops included on all models at no extra cost. Please specify if the drum is to be used for marching, equipped with eye carrying hooks, key tension rods and double-ply heads.



- No. 917L—14" x 18" Choice of Lacquer colors. \$ 88.00
- No. 917P—14" x 18" Choice of Pearl finishes. . 124.00
- No. 918L—12" x 18" Choice of Lacquer colors. . 84.50
- No. 918P—12" x 18" Choice of Pearl finishes. . 121.00
- No. 919L—12" x 20" Choice of Lacquer colors. . 110.00
- No. 919P—12" x 20" Choice of Pearl finishes. . 146.00
- No. 920L—14" x 20" Choice of Lacquer colors. . 114.00
- No. 920P—14" x 20" Choice of Pearl finishes. . 150.00
- No. 921L—12" x 22" Choice of Lacquer colors. . 117.00
- No. 921P—12" x 22" Choice of Pearl finishes. . 154.00
- No. 922L—14" x 22" Choice of Lacquer colors. . 123.00
- No. 922P—14" x 22" Choice of Pearl finishes. . 160.00
- No. 924L—14" x 24" Choice of Lacquer colors. . 135.00
- No. 924P—14" x 24" Choice of Pearl finishes. . 172.00
- No. 926L—14" x 26" Choice of Lacquer colors. . 150.00
- No. 926P—14" x 26" Choice of Pearl finishes. . 186.00
- No. 928L—14" x 28" Choice of Lacquer colors. . 154.00
- No. 928P—14" x 28" Choice of Pearl finishes. . 190.00

To avoid excessive tension stress on the shell in larger concert sizes, we recommend the SYMPHONIC models listed on page 38.

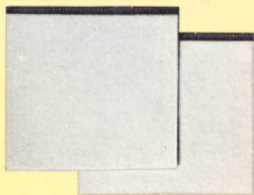

BASS DRUM IMPACT PAD

Ludwig's new "Impact Pads" are recommended for use on all outfit bass drums at beater ball contact area. Two pressure-sensitive adhesive cloth pads to a package.

No. 1288—2 Bass Drum Impact Pads \$1.00

BASS DRUM MUFFLER

The Ludwig bass drum muffler provides complete control of head ring. Set screw adjusts pressure tension on head, angle adjustment arm enables muffler to be placed in different positions.

No. 136—Adjustable Bass Drum Muffler \$6.00

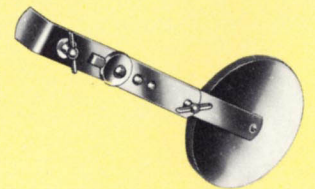

BASS DRUM ANCHOR

The Anchor prevents bass drum from "creeping" when being played. Reversible tips offer choice of rubber or steel points. Available in chrome only.

No. 1304-1—Bass Drum Anchor \$5.50

ROCKSTOP SPUR STOP

Designed to hold bass drum in place on slippery floors. Fits under spurs, anchors or hi-hat spur to eliminate "creep" during playing. Protects rugs and floors.

No. 1302—Rockstop Spur Stop, per pair \$4.50

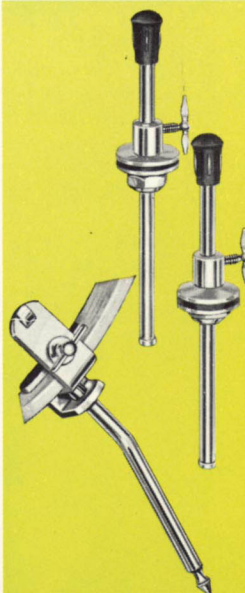

DISAPPEARING SPURS

Disappearing spurs are mounted on shell and disappear into bass drum when not in use. Provides fast set up.

No. 1303C—Disappearing Spurs, Pair, chrome . . \$6.00

GIANT SPURS

Ludwig Giant Spurs mount on bass drum counter hoop. Will fit all size bass drums. Available in chrome only.

No. 1301—Giant Spurs, pair . . . \$5.00



NEW "SURE GRIP" CURVED RETRACTING SPURS

Ludwig now offers the most advanced design bass drum spur available that will stabilize and hold any bass drum in place. The curved retracting spurs angle forward for maximum holding power.

No. 1306—Curved Retracting Spurs, pair \$8.00

LUDWIG CENTURY SEPARATE TENSION

A superior line of moderately priced Separate Tension bass drums featuring streamlined self-aligning casings. Modern machine turned "T" handles and double claw hooks provide even head tensioning. The center mounted tension casings distribute stress on the shell. Pearl inlaid hoops included on all models at no extra cost. Please specify if the drum is to be used for marching, equipped with eye carrying hooks, key tension rods and double-ply heads.

| | |
|--------------------------------------------------------|----------|
| No. 3244L—14" x 20" Choice of Lacquer colors | \$105.00 |
| No. 3244P—14" x 20" Choice of Pearl finishes | 141.50 |
| No. 3246L—14" x 22" Choice of Lacquer colors | 112.00 |
| No. 3246P—14" x 22" Choice of Pearl finishes | 147.00 |
| No. 3248L—14" x 24" Choice of Lacquer colors | 123.00 |
| No. 3248P—14" x 24" Choice of Pearl finishes | 160.00 |
| No. 3252L—14" x 28" Choice of Lacquer colors | 136.00 |
| No. 3252P—14" x 28" Choice of Pearl finishes | 172.50 |



LUDWIG CENTURY SINGLE TENSION

The economy of single tension plus the modern styling of more expensive models add to the value of this popular line. Streamlined center lug provides support and protection to tension rod and shell. Available in your choice of pearl or lacquer finish with glistening chrome-plated hardware. Please specify if the drum is to be used for marching, equipped with eye carrying hooks, key tension rods and double-ply heads.

| | |
|--------------------------------------------------------|----------|
| No. 3264L—14" x 20" Choice of Lacquer colors | \$ 94.00 |
| No. 3264P—14" x 20" Choice of Pearl finishes | 130.00 |
| No. 3266L—14" x 22" Choice of Lacquer colors | 105.00 |
| No. 3266P—14" x 22" Choice of Pearl finishes | 140.00 |
| No. 3268L—14" x 24" Choice of Lacquer colors | 115.00 |
| No. 3268P—14" x 24" Choice of Pearl finishes | 152.50 |
| No. 3272L—14" x 28" Choice of Lacquer colors | 128.00 |
| No. 3272P—14" x 28" Choice of Pearl finishes | 164.50 |

Pearl inlaid hoops on Lacquer models extra—\$7.50

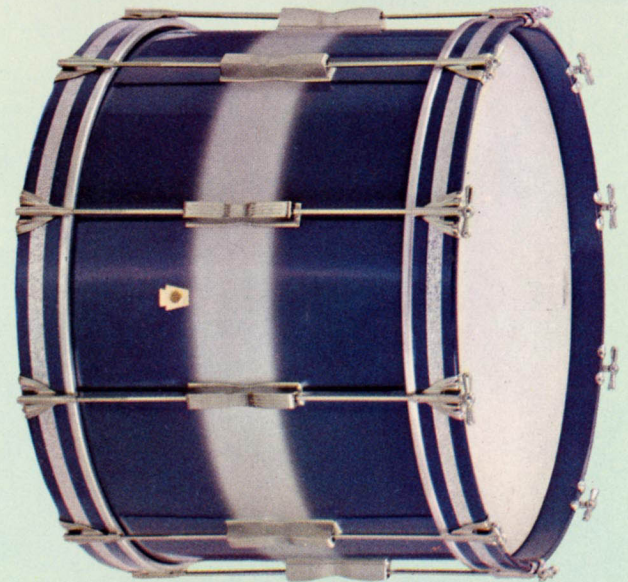

LUDWIG STANDARD SINGLE TENSION

The STANDARD line of single tension bass drums features the same quality shell construction, heads and hoops as more expensive models. Head tensioning is provided by precision machined "T" handle tension rods and double claw hooks. Center support studs align tension rods. Available in your choice of mahogany or lacquer colors only. Please specify if the drum is to be used for marching, equipped with eye carrying hooks, key tension rods and double-ply heads.

| | |
|----------------------------------------------------------|----------|
| No. 829L—12" x 20" Choice of Lacquer colors | \$ 91.00 |
| No. 830L—14" x 20" Choice of Lacquer colors | 100.00 |
| No. 832L—14" x 22" Choice of Lacquer colors | 110.50 |
| No. 833 —14" x 28" (M) Mahogany or (L) Lacquer | 121.00 |

Pearl inlaid hoops extra—\$7.50

LUDWIG CONCERT BASS DRUMS

The famous LUDWIG line of concert bass drums has long been the choice of leading musical organizations the world over. Acoustically designed shells are solidly reinforced with sturdy rock-maple glue rings to maintain perfect roundness and to eliminate tone distortion. Matched heads, self-aligning tension casings, solid maple counter hoops and the finest in finishes are all extra value features. Triple chrome-plating on all hardware assures lasting beauty.

SPECIFICATIONS:

Ludwig "SYMPHONIC STYLE" concert bass drums are built to professional standards and are available in a wide range of sizes. The popular 16" x 36" size is recommended for most concert work. All models available in choice of pearl, lacquer or mahogany finish with bright glistening "triple" chrome-plated hardware.

- No. 801L—14" x 28" Mahogany or Lacquer finishes \$154.00
- No. 801P—14" x 28" Choice of Pearl finishes 190.00
- No. 802L—14" x 30" Mahogany or Lacquer finishes 166.00
- No. 802P—14" x 30" Choice of Pearl finishes 202.50
- No. 804L—16" x 32" Mahogany or Lacquer finishes 185.00
- No. 804P—16" x 32" Choice of Pearl finishes 221.00
- No. 805L—16" x 34" Mahogany or Lacquer finishes 197.00
- No. 805P—16" x 34" Choice of Pearl finishes 234.00
- No. 806L—16" x 36" Mahogany or Lacquer finishes 215.00
- No. 806P—16" x 36" Choice of Pearl finishes 252.00
- No. 807L—18" x 36" Mahogany or Lacquer finishes 231.00
- No. 807P—18" x 36" Choice of Pearl finishes 268.00
- No. 808L—18" x 40" Mahogany or Lacquer finishes 253.00
- No. 808P—18" x 40" Choice of Pearl finishes 290.00

Pearl inlaid counter hoops are standard on all pearl models. Available at \$7.50 extra on mahogany or lacquer drums. Special sizes upon request.



CONCERT BASS DRUM FOLDING STAND

This chrome plated tubular stand offers a concert bass drum sturdy support. It has ample bumper protection and is adjustable for varying the height of a bass drum's position in use, vertical or horizontal.

- No. 790—FOLDING BASS DRUM STAND
for 28" to 36" diameter drums,
illustrated \$21.00



THE IMPERIAL HIGH TENSION CASING

The beautifully styled self-aligning tension casings are precision engineered to evenly distribute head tension within itself, thus eliminating excessive stress on the shell.

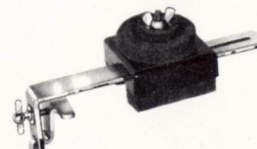

BASS DRUM CYMBAL HOLDER

Holds cymbal securely on bass drum for combination bass drum and cymbal playing. Attaches to bass drum hoop.

- No. 357—BASS DRUM CYMBAL HOLDER . . . \$6.00

CONCERT BASS DRUM TILTER STAND

...offering complete angle adjustment

Ludwig's new concept in bass drum stands, the tilting bass drum stand, locks the drum at any desired angle. Now the performer can select the proper playing position for his instrument to achieve maximum control and tonal effect. The tilting bass drum stand is available in two models to accommodate bass drums from 32" to 40" diameter and can be permanently mounted on any bass drum. Its rugged, heavy duty aluminum construction provides a solid hold on the drum yet is light in weight. Four large coaster wheels allow easy transport.

No. 792—TILTING BASS DRUM STAND
for 32", 34", and 36" diameter drums \$110.00

No. 793—TILTING BASS DRUM STAND
for 40" diameter drum 110.00

FULL DROP BASS DRUM COVER

Protect valuable concert bass drums with a full drop cover made of heavy duty Mackintosh material. Designed for use with the Ludwig Tilting Bass Drum Stand, or standard stands. Available in two sizes.

No. 637—FULL DROP BASS DRUM COVER
for 32" and 34" diameter drums . \$25.00

No. 638—FULL DROP BASS DRUM COVER
for 36" and 40" diameter drums . 28.00



LUDWIG BASS DRUM CARRIAGE

Compact, lightweight and highly maneuverable, Ludwig's bass drum carriage makes it possible to obtain the concert tone of a large bass drum on the march. Designed to fit any size from 14" x 28" on up, carriage may be pulled for player or is easily pushed by the player himself.

No. 791—BASS DRUM CARRIAGE \$140.00

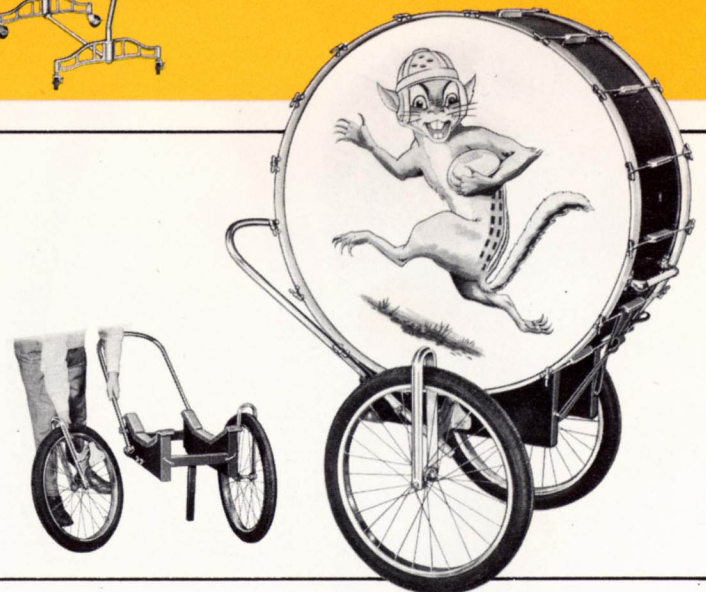

DRUM HEAD PAINTINGS

No. 1350—Head Lettering, one color—black unless otherwise specified, per letter, \$ 1.50

No. 3152—Head Lettering, one color—specify, with black outline, per letter, 2.00

No. 1351—Shield Monogram, one color—black unless otherwise specified, your initials, 18.00

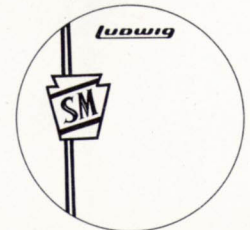

LUDWIG

experience/imagination/craftsmanship



LUDWIG HIGH-TENSION BASS DRUMS

Ludwig's HIGH-TENSION Bass Drum line has proven to be very successful with drum corps and marching bands. The drums provide a resonant voice that can dominate or blend, depending upon how they are played.

The HIGH-TENSION line features Ludwig's modern high-tension lug that relieves excessive stress on the shell. Key tension rods and double claw hooks provide even head tensioning. All shells are finished inside to provide for a more resonant sound.

Available in choice of lacquer or pearl finishes with glistening chrome-plated hardware. Eye hooks are mounted; carrying sling is supplied with drum. Mounted with single ply heads; double ply heads are available upon request. Supplied with a pair of suitable beaters.

| | |
|--------------------------------------------|----------|
| No. 1183L—12" x 20" Choice of Lacquer..... | \$122.00 |
| No. 1183P—12" x 20" Choice of Pearl..... | 140.00 |
| No. 1181L—12" x 24" Choice of Lacquer..... | 128.00 |
| No. 1181P—12" x 24" Choice of Pearl..... | 154.00 |
| No. 1180L—14" x 26" Choice of Lacquer..... | 144.00 |
| No. 1180P—14" x 26" Choice of Pearl..... | 168.00 |
| No. 1182L—14" x 28" Choice of Lacquer..... | 150.00 |
| No. 1182P—14" x 28" Choice of Pearl..... | 174.00 |
| No. 1184L—16" x 30" Choice of Lacquer..... | 190.00 |
| No. 1184P—16" x 30" Choice of Pearl..... | 210.00 |
| No. 1185L—16" x 32" Choice of Lacquer..... | 200.00 |
| No. 1185P—16" x 32" Choice of Pearl..... | 220.00 |

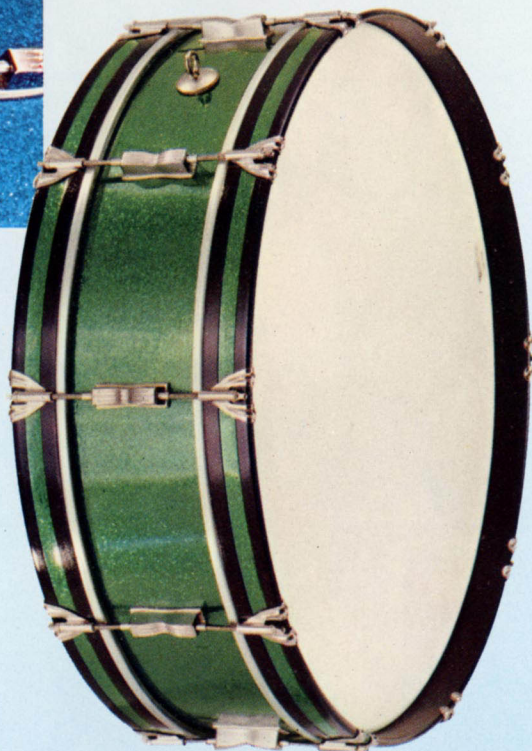
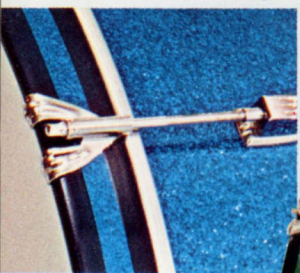

THIN LINE SCOTCH BASS DRUMS

Used for young age marching groups or as an intermediate voice between tenor and scotch bass drums, the THIN LINE Scotch Bass Drums provide marching units with the needed added dimension in sound color.

The THIN LINE features separate tension self-aligning casings, key tension rods and double claw hooks for even head tensioning. Equipped with eye hooks and supplied with carrying sling and a suitable pair of beaters. Mounted with single ply heads.

| | |
|-------------------------------------------|----------|
| No. 3216L—6" x 26" Choice of Lacquer..... | \$120.00 |
| No. 3216P—6" x 26" Choice of Pearl..... | 144.00 |
| No. 3217L—6" x 28" Choice of Lacquer..... | 131.00 |
| No. 3217P—6" x 28" Choice of Pearl..... | 154.00 |

TENOR DRUM VERTI-HOLDER

The Ludwig originated VERTI-HOLDER has proven popular with leading marching bands across the nation. Holder places tenor drum in vertical position for playing ease and added flash. It offers a "new look" to the drum section. Holder folds against shell when not in use.

Supplied in white lacquer only, complete with eye hooks, torso and waist slings.

No. 477—VERTI-HOLDER, complete . . . \$25.00

No. 368—Verti-Holder Sling Assembly, complete . . . \$6.55

Verti-Holder Sling Parts:

No. 350—Torso Sling \$4.90

No. 369—Waist Sling \$2.00

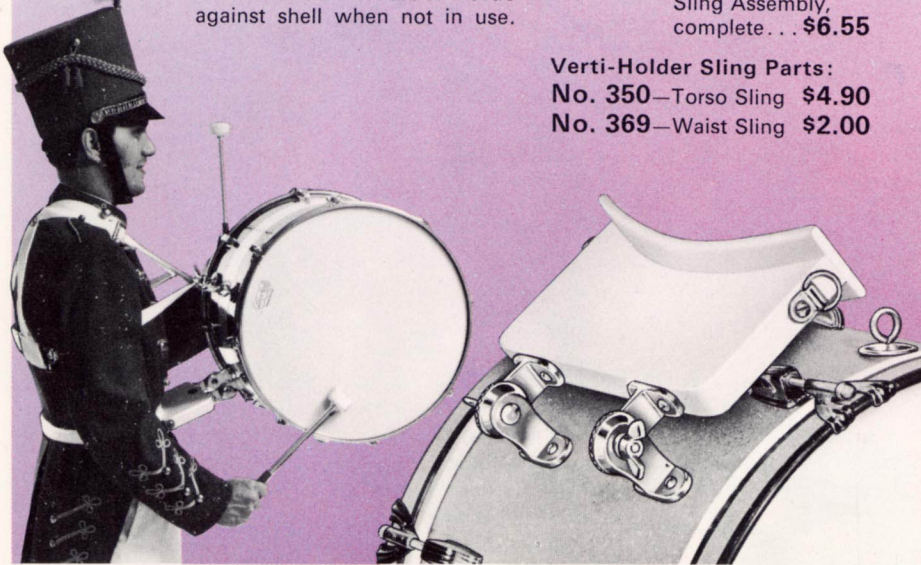

DRUM MAJOR SIGNAL BATONS

Ludwig's SIGNAL BATONS are crafted from select hickory, carefully sanded and finished to a high gloss. Ball and ferrule are chrome plated. Perfectly balanced!

Available in dark blue enamel with gold cord and tassel unless otherwise specified. Other colors at additional cost.

No. 116 —38" Signal Baton, standard \$24.00

No. 116S—38" Signal Baton, special 26.00

No. 118 —44" Signal Baton, standard 25.00

No. 118S—44" Signal Baton, special 27.00

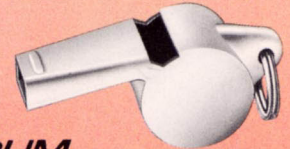

DRUM MAJOR WHISTLE

The finest Drum Major whistle made. The Acme "Thunderer" possesses great, piercing carrying power! Made in England.

No. 118W—ACME "THUNDERER" WHISTLE \$2.30

MULTI-ANGLE CARRYING HOOK

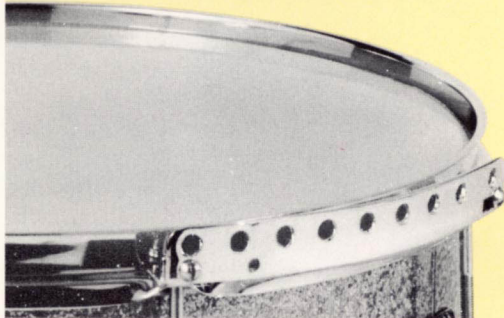

This new adjustable carrying hook is one of Ludwig's latest marching accessories. The carrying hook is easily attached to the collar screw rods of any tenor or snare drum and provides a selection of sling hook-ups. This allows the drum to be carried at several desired angles to meet the physical requirements of the individual player, thus offering more comfort on the march.

No. 475—MULTI-ANGLE CARRYING HOOK . . . \$4.00

DRUM AND TIMPANI SLINGS

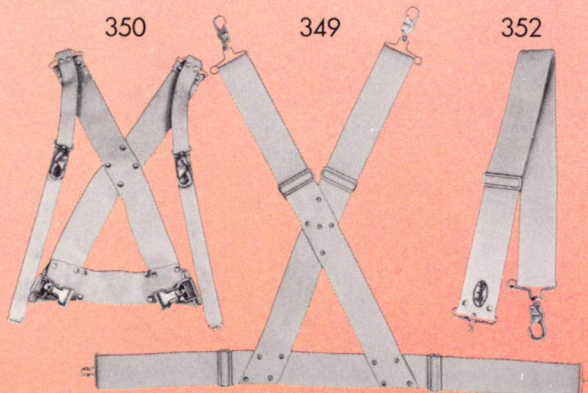

Designed for maximum carrying ease and control of the instrument these quality made slings are fully adjustable. Available in white only.

No. 349—Cadet Bass Drum Sling \$5.50

No. 350—Standard Bass Drum Sling 6.00

No. 352—Parade Drum Sling 2.60

No. 367—Timp-Tom or Timpani Sling Assembly, complete 7.40

Timp-Tom and Timpani Sling Parts:

No. 352—Shoulder Sling for right side 2.60

No. 352L—Shoulder Sling for left side 2.60

No. 361—Waist Sling 2.60

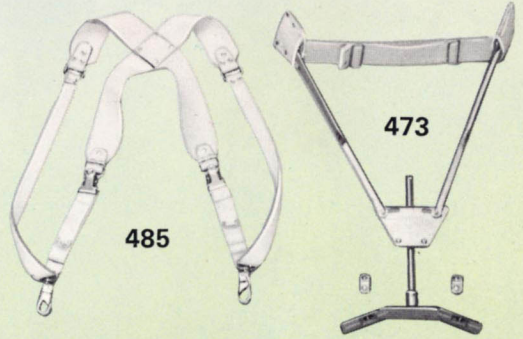

HI-STEPPER

Designed to hold a field snare or tenor drum out and away from the body torso, this carrier allows the drummer freedom of leg and arm movement. In addition, it provides maximum carrying ease and control of the instrument.

No. 473—HI-STEPPER, complete . \$38.00B

No. 485—Hi-Stepper, Sling Assembly, complete 16.00B

SWING FLAGS

Ludwig's SWING FLAGS are complete with flag, spring clip, steel shaft and rubber molded handle. Available in white only. Flag can be easily dyed, with any commercial color-fast dye by the purchaser.

No. 113—32" Swing Flag, complete . . . \$11.00

No. 114—40" Swing Flag, complete . . . 12.65

No. 111—32" Shaft with handle, only . . . 6.50

No. 112—40" Shaft with handle, only . . . 6.50

LUDWIG *new marching percussion*



See pages 62 & 63 for Conga, Bongo and Timbale listings without stand to mount on No. 469 holder.



570

NEW! LUDWIG TIMP-TOM TRIOS

The latest innovation in marching percussion, the timpano trio extends the color range of percussion on the march. Each drum in the trio is tunable. Each timpano unit is complete with carrying holder, balanced slings and a suitable pair of mallets. Fibre cases and leg assembly for concert playing, available at extra cost.

NEW! MULTI-MOUNT CARRYING HOLDER

Completely versatile, this carrying holder will accommodate drum diameters from 28" to 14". In addition, it will carry a set of twin congas and bongos (illustrated) or timbales and bongos. (See pages 62 & 63 for instrument listings without stand.) Especially crafted of sturdy metal and amply padded; complete with balanced sling assembly.



469

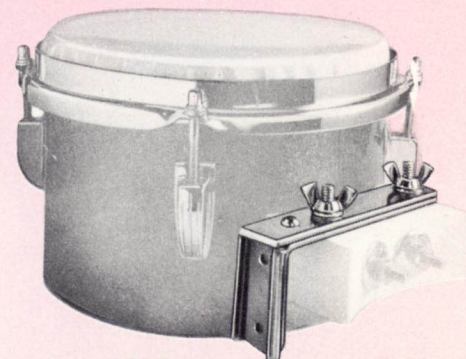

1338

No. 469—MULTI-MOUNT CARRYING HOLDER (illustrated), complete \$46.00

No. 1338—METAL ATTACHMENT for Mounting No. 2358 Bongos to No. 469 Multi-Mount Carrying Holder (illustrated) \$4.00

MARCHING TIMP-TOM UNITS

TENOR TRIO COMBINATIONS

| | Range | Lacquer | Pearl |
|----------------------------------------------------------|------------------------------------|----------|----------|
| No. 570—10" Depth X 18", 16" and 14" Diameter, complete. | G ^{b4} to E ^{b5} | \$233.00 | \$285.00 |
| No. 571—12" Depth X 18", 16" and 14" Diameter, complete. | E ⁴ to D ^{b5} | 247.00 | 300.00 |
| No. 572—12" Depth X 20", 18" and 16" Diameter, complete. | D ^{b4} to B ^{b4} | 294.00 | 350.00 |
| No. 573—14" Depth X 20", 18" and 16" Diameter, complete. | B ³ to A ^{b4} | 308.00 | 364.00 |

BARITONE TRIO COMBINATIONS

| | | | |
|----------------------------------------------------------|-----------------------------------|--------|----------|
| No. 574—12" Depth X 22", 20" and 18" Diameter, complete. | B ^{b3} to G ⁴ | 336.00 | \$393.00 |
| No. 575—14" Depth X 22", 20" and 18" Diameter, complete. | A ^{b3} to F ⁴ | 355.00 | 422.00 |
| No. 576—12" Depth X 24", 22" and 20" Diameter, complete. | G ³ to E ⁴ | 350.00 | 408.00 |
| No. 577—14" Depth X 24", 22" and 20" Diameter, complete. | F ³ to D ⁴ | 365.00 | 422.00 |
| No. 578—16" Depth X 24", 22" and 20" Diameter, complete. | E ^{b3} to C ⁴ | 379.00 | 436.00 |

BASS TRIO COMBINATIONS

| | | | |
|----------------------------------------------------------|-----------------------------------|--------|--------|
| No. 579—14" Depth X 26", 24" and 22" Diameter, complete. | D ³ to B ³ | 379.00 | 436.00 |
| No. 580—16" Depth X 26", 24" and 22" Diameter, complete. | C ³ to A ³ | 393.00 | 450.00 |
| No. 581—14" Depth X 28", 26" and 24" Diameter, complete. | B ² to A ^{b3} | 393.00 | 450.00 |
| No. 582—16" Depth X 28", 26" and 24" Diameter, complete. | A ² to G ^{b3} | 408.00 | 465.00 |

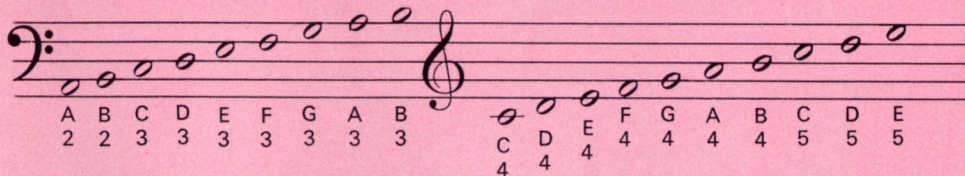

FIBRE CASES FOR TIMP-TOM UNITS (Drums only)

| | |
|------------------------------------|---------|
| No. 6893—for 570 and 571... | \$41.50 |
| No. 6890—for 572 and 573... | 41.00 |
| No. 6991—for 574 and 575... | 41.00 |
| No. 8680—for 576, 577 and 578..... | 43.00 |
| No. 8681—for 579 and 580... | 43.00 |
| No. 8682—for 581 and 582... | 44.00 |
| No. 8122—for 469 Holder, only..... | 19.00 |

SUGGESTED PLAYING RANGES FOR EACH TIMP-TOM

| | |
|----------------------------------------------|----------------------------------------------|
| 10" X 14"—C ⁵ to E ^{b5} | 12" X 22"—B ^{b3} to D ^{b4} |
| 12" X 14"—B ^{b4} to D ^{b5} | 14" X 22"—A ^{b3} to B ³ |
| 10" X 16"—A ⁴ to C ⁵ | 16" X 22"—G ^{b3} to A ³ |
| 12" X 16"—G ⁴ to B ^{b4} | 12" X 24"—G ³ to B ^{b3} |
| 14" X 16"—F ⁴ to A ^{b4} | 14" X 24"—F ³ to A ^{b3} |
| 10" X 18"—G ^{b4} to A ⁴ | 16" X 24"—E ^{b3} to G ^{b3} |
| 12" X 18"—E ⁴ to G ⁴ | 14" X 26"—D ³ to F ³ |
| 14" X 18"—D ⁴ to F ⁴ | 16" X 26"—C ³ to E ^{b3} |
| 12" X 20"—D ^{b4} to E ⁴ | 14" X 28"—B ² to D ³ |
| 14" X 20"—B ³ to D ⁴ | 16" X 28"—A ² to C ³ |
| 16" X 20"—A ³ to C ⁴ | |

MARCHING MACHINE TIMPANI

Ludwig's Lightweight Marching Machine Timpani provide an additional dimension to the drum line. The kettles are completely portable. Supplied with tuning gauges and handles for instantaneous adjustment (to provide a wide range of accurate notes), retracting legs, carrying slings, leg rest and a pair of suitable mallets.

Fibre cases available at extra cost. (See page 101.)

No. 1860—20" MARCHING MACHINE TIMPANO, aluminum kettle, satin copper finish, complete. \$207.00B

No. 1871—23" MARCHING MACHINE TIMPANO, fiberglass kettle, satin copper finish, complete (as illustrated) . . . \$207.00B

No. 1872—26" MARCHING MACHINE TIMPANO, fiberglass kettle, satin copper finish, complete. . . . \$227.00B

No. 1873—29" MARCHING MACHINE TIMPANO, fiberglass kettle, satin copper finish, complete. . . . \$245.00B

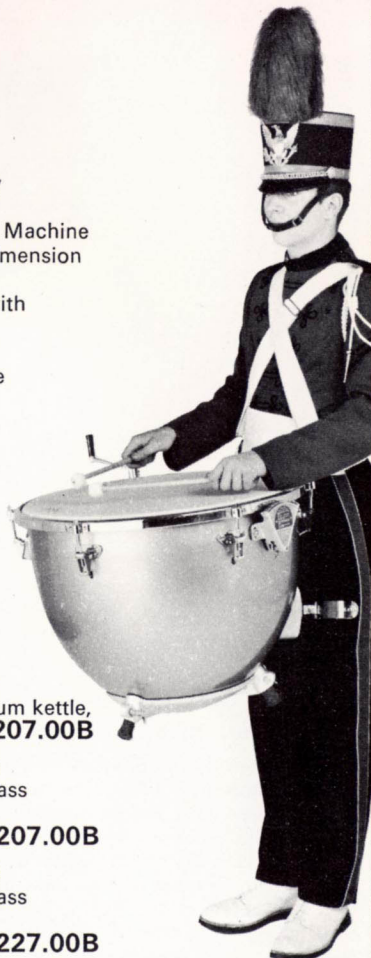

MARCHING CONGAS, BONGOS, TIMBALES

Developed to meet the ever increasing demands for marching units, Ludwig's ever-expanding concept of marching percussion includes the completely portable Latin-American membranitic instruments.

Marching Multi-Latin-American Units, complete, are available upon request.

MARCHING HOLDER FOR BONGOS OR TIMBALES

With this holder a set of Bongos or Timbales can be easily carried separately. Especially crafted of sturdy hardwood, amply padded; complete with hardware and balanced sling assembly.

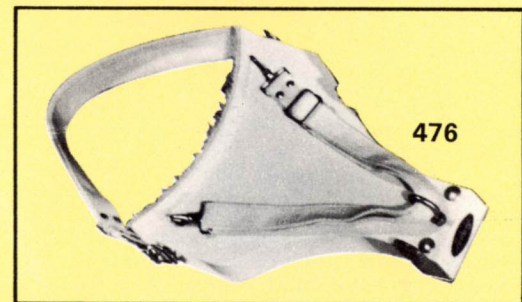

No. 476—MARCHING HOLDER FOR BONGOS OR TIMBALES (illustrated) complete. . . . \$23.00

MARCHING BONGOS

No. 2356L—TUNABLE BONGOS, choice of lacquer finishes with clip attachments for mounting on No. 476 holder. . . . \$60.00

No. 2356P—TUNABLE BONGOS, choice of pearl finishes with clip attachments for mounting on No. 476 holder. . . . \$73.00

(See page 63 for Timbale listings without stand.)

LUDWIG ALL-METAL PARADE DRUMS

SUPER-SENSITIVE CHROME-PLATED MODELS



No. 425—12" x 15"

No. 422—12" x 15"

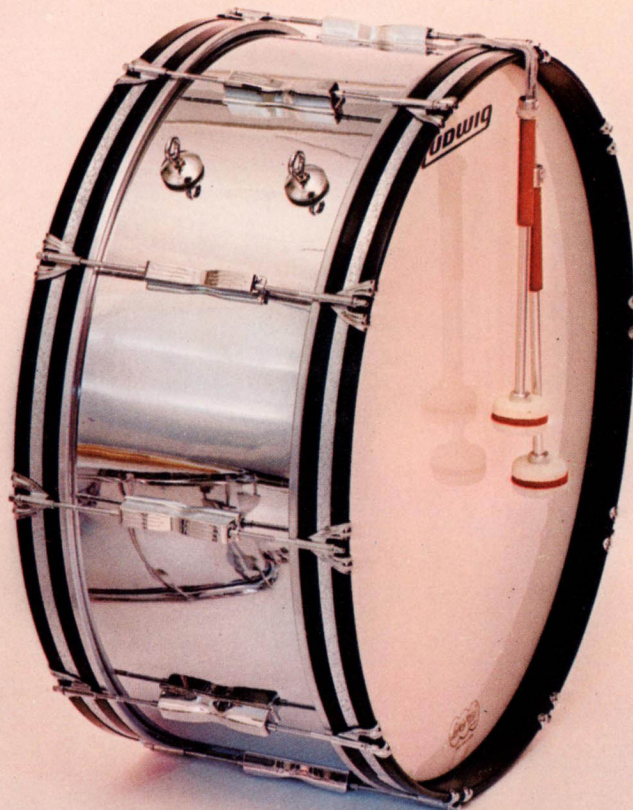

No. 428—10" x 26"
(Sling Included)

Ludwig introduces another brand new concept in sound with all-new, all-metal SUPER-SENSITIVE parade drums. The glistening SUPER-SENSITIVE presents a striking "sound" advance in marching percussion that will set off your marching unit as something especially exciting, not only in looks, but in magnificent drum tone! The seamless, triple chrome-plated all-metal shells, with the new P-70 SUPER-SENSITIVE strainer, are mirror bright and produce a clear, clean, crisp tone that you can appreciate only when you play them. If you're looking for something dramatically different in quality equipment, consider the *new* SUPER-SENSITIVE all-metal parade drums. Ten high-tension lugs provide the finest tuning possible on any drum; WEATHER MASTER plastic heads are standard. Sticks, beaters and slings included. Leg rests and fibre carrying cases available at extra cost.

- No. 420—10" x 14" SUPER-SENSITIVE all-metal snare drum \$150.00
- No. 422—12" x 15" SUPER-SENSITIVE all-metal snare drum 165.00

Choice of snares listed below. If not specified, 15 strand individually adjustable wire snares will be supplied.

SUPER-SENSITIVE SNARE UNITS

- No. 1232—24 Strand Wire Snares, NOT individually adjustable . . . \$17.50
- No. 1233—15 Strand Wire Snares, individually adjustable strands . . . \$17.50
- No. 1234—9 Wire 6 Gut Snares, individually adjustable strands . . . \$20.00
- No. 1235—15 Gut Snares, individually adjustable strands \$22.50
- No. 1236—15 Nylon Snares, individually adjustable strands \$22.50
- No. 1237—9 Wire 6 Nylon Snares, individually adjustable strands . . \$20.00
(Specify size needed)
- No. 424—10" x 14" SUPER-SENSITIVE all-metal tenor drum \$135.00
- No. 425—12" x 15" SUPER-SENSITIVE all-metal tenor drum 150.00
- No. 428—10" x 26" SUPER-SENSITIVE all-metal bass drum 175.00

HIGH-TENSION CHROME-PLATED MODELS



No. 435—12" x 15"



No. 432—12" x 15"



No. 428—10" x 26"
(Sling Included)

The Ludwig all-metal HIGH-TENSION parade drums are triple chrome-plated for a bright, lustrous finish. Quality constructed and designed to withstand the extremely high head tensioning demanded by today's modern marching bands and drum corps, the new HIGH-TENSION drums feature 8 self-aligning HIGH-TENSION lugs, all-metal ACOUSTI-PERFECT seamless shell design and the popular Classic Strainer. The chrome-plated P-33 extended snare butt, with die-cast housing, permits individual adjustment of all snare strands. All parts are triple chrome-plated to give your marching unit the brightest, most modern look to date. Here is exceptional quality in both brilliant appearance and remarkable performance. Sticks, beaters and slings included. Leg rests and fibre carrying cases available at extra cost.

No. 430—10" x 14" HIGH-TENSION all-metal snare drum, 12-strand wire snares \$138.00

No. 432—12" x 15" HIGH-TENSION all-metal snare drum, 12-strand wire snares 153.00

Choice of snares listed below. If not specified, 12 strand individually adjustable wire snares will be supplied.

HIGH-TENSION SNARE UNITS

No. 1112—Gut Snares with adjusting plate, individually adjustable strands \$17.50

No. 1113—Wire-Gut Snares with adjusting plate, individually adjustable strands \$15.00

No. 1114—Wire Snares with adjusting plate, individually adjustable strands \$12.00

No. 1117—Nylon Snares with adjusting plate, individually adjustable strands \$17.50

No. 1118—Wire-Nylon Snares with adjusting plate, individually adjustable strands \$15.00
(Specify size needed)

No. 434—10" x 14" HIGH-TENSION all-metal tenor drum \$126.00

No. 435—12" x 15" HIGH-TENSION all-metal tenor drum 141.00

No. 428—10" x 26" HIGH-TENSION all-metal bass drum 175.00

LUDWIG SUPER-SENSITIVE PARADE DRUMS

WITH 4 CHOICES OF SNARE COMBINATIONS

LUDWIG presents striking advances in marching percussion bringing exciting clarity and brilliance to parade drums. The new SUPER-SENSITIVE P-70 snare strainer has been incorporated in this line of parade drums providing effortless, undistorted, choke-free response heretofore found only in the finest concert drums. The new SUPER-SENSITIVE incorporates these exclusive Ludwig features: 10 high-tension lugs, ACOUSTI-PERFECT shell design, hot clear lacquer interior finish, triple flanged hoops and your choice of 4 different snare combinations which can be changed in less than a minute. Here is an instrument that is the ultimate in the drum maker's art.

Supplied with 15 strand individually adjustable wire snares, unless specified otherwise.

SUPER-SENSITIVE SNARE DRUMS

| | | |
|----------------------------------------------|---|----------|
| No. 1270L—10" x 14" Choice of Lacquer colors | } | \$124.00 |
| No. 1276L—10" x 15" Choice of Lacquer colors | | |
| No. 1272L—12" x 15" Choice of Lacquer colors | } | 138.00 |
| No. 1273L—12" x 16" Choice of Lacquer colors | | |
| No. 1270P—10" x 14" Choice of Pearl finishes | } | 142.00 |
| No. 1276P—10" x 15" Choice of Pearl finishes | | |
| No. 1272P—12" x 15" Choice of Pearl finishes | } | 156.50 |
| No. 1273P—12" x 16" Choice of Pearl finishes | | |

SUPER-SENSITIVE SNARE UNITS

(Specify size needed)

| | |
|--------------------------------------------------------------------------------|---------|
| No. 1232—24 Strand Wire, NOT individually adjustable | \$17.50 |
| No. 1233—15 Strand Wire, individually adjustable snares | \$17.50 |
| No. 1234—9 Strand Wire, 6 Strand Gut, individually adjustable snares | \$20.00 |
| No. 1235—15 Strand Gut, individually adjustable snares | \$22.50 |

SUPER-SENSITIVE TENOR DRUMS

| | |
|--------------------------------------------------|----------|
| No. 1265L—12" x 15" Choice of Lacquer colors . | \$121.00 |
| No. 1267L—12" x 17" Choice of Lacquer colors . | 124.00 |
| No. 1265P—12" x 15" Choice of Pearl finishes . . | 139.00 |
| No. 1267P—12" x 17" Choice of Pearl finishes . . | 144.00 |

SUPER-SENSITIVE BASS DRUMS

| | |
|------------------------------------------------|----------|
| No. 1178L—10" x 26" Choice of Lacquer colors . | \$136.00 |
| No. 1179L—10" x 28" Choice of Lacquer colors . | 146.00 |
| No. 1182L—14" x 28" Choice of Lacquer colors . | 156.00 |
| No. 1178P—10" x 26" Choice of Pearl finishes . | 160.00 |
| No. 1179P—10" x 28" Choice of Pearl finishes . | 170.00 |
| No. 1182P—14" x 28" Choice of Pearl finishes . | 180.00 |



Sticks and slings included. Pearl inlaid counter hoops are standard on all pearl models. Available at \$7.50 extra on lacquer drums. When ordering covers, add one extra inch in diameter for snare guard. Leg rests available at extra cost.



DUAL SNARE RELEASE WITH FULLY EXTENDED SNARES

A single control lever releases both sides of the snares simultaneously. The snares are moved away, and returned to the snare head under uniform tension. The only drum with snares extended across and beyond the entire diameter of the drum head providing a full free snare vibration.

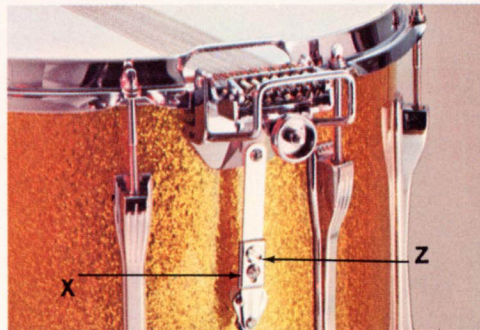

DOUBLE SNARE TENSIONING

All snare units are tensioned from both sides of the shell by the diamond knurled screw located in each mechanism attached to the shell. Additional adjustments, for the desired amount of snare pressure-contact, can be made with the height adjustment screw (X) or the eccentric screw (Z). These screws are located on the control link.

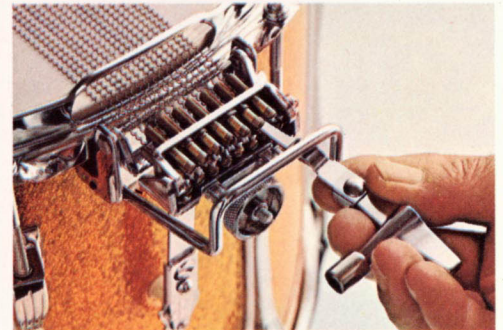

INDIVIDUAL SNARE ADJUSTMENT

All snare units feature individual snare strand adjustment, assuring perfectly balanced snare action, except the 24 strand wire unit which is on triple swivel mounts. Special tuning key is equipped with swivel screw driver attachment which has been designed to adjust individual snares. To tighten snare, merely turn to the left, or to loosen snare, turn to the right.

HIGH-TENSION PARADE DRUMS WITH BRILLIANT STYLING



No. 1182P—14" x 28"
(Sling Included)



No. 1165P —12" x 15"



No. 1172P —12" x 15"

Ludwig's HIGH-TENSION parade drum line offers the finest in styling, tonal response and quality construction. Designed and built to take the extremely high head tensioning demanded by today's modern bands and drum corps, the line features 8 self-aligning lugs, new ACOUSTI-PERFECT shell designs, hot clear lacquer interior finish and the popular Classic Strainer. All drums are available in your choice of lacquer, pearl or Multi-Sparkle* pearl finishes. Supplied with 12-strand individually adjustable wire snare, unless specified otherwise.

HIGH-TENSION SNARE DRUMS

| | |
|--------------------------------------------------------|------------|
| No. 1170L—10" x 14" Choice of Lacquer colors | } \$ 99.00 |
| No. 1176L—10" x 15" Choice of Lacquer colors | |
| No. 1172L—12" x 15" Choice of Lacquer colors | } 115.00 |
| No. 1173L—12" x 16" Choice of Lacquer colors | |
| No. 1170P—10" x 14" Choice of Pearl finishes | } 117.50 |
| No. 1176P—10" x 15" Choice of Pearl finishes | |
| No. 1172P—12" x 15" Choice of Pearl finishes | } 133.50 |
| No. 1173P—12" x 16" Choice of Pearl finishes | |

HIGH-TENSION SNARE UNITS (Specify size needed)

| | |
|------------------------------------------------------------------------------------------|---------|
| No. 1112—Gut Snares with Adjusting Plate, individually adjustable strands | \$17.50 |
| No. 1113—Wire-Gut Snares with Adjusting Plate, individually adjustable strands | 15.00 |
| No. 1114—Wire Snares with Adjusting Plate, individually adjustable strands | 12.00 |

HIGH-TENSION TENOR DRUMS

| | |
|--------------------------------------------------------|----------|
| No. 1165L—12" x 15" Choice of Lacquer colors | \$115.00 |
| No. 1167L—12" x 17" Choice of Lacquer colors | 118.50 |
| No. 1165P—12" x 15" Choice of Pearl finishes | 133.50 |
| No. 1167P—12" x 17" Choice of Pearl finishes | 137.00 |

HIGH-TENSION BASS DRUMS

| | |
|--------------------------------------------------------|----------|
| No. 1178L—10" x 26" Choice of Lacquer colors | \$136.00 |
| No. 1179L—10" x 28" Choice of Lacquer colors | 146.00 |
| No. 1182L—14" x 28" Choice of Lacquer colors | 156.00 |
| No. 1178P—10" x 26" Choice of Pearl finishes | 160.00 |
| No. 1179P—10" x 28" Choice of Pearl finishes | 170.00 |
| No. 1182P—14" x 28" Choice of Pearl finishes | 180.00 |

Sticks and slings included. Pearl inlaid counterhoops are standard on all pearl models. Available at \$7.50 extra on lacquer drums. When ordering covers, add one extra inch in diameter for snare guard. Leg rests available at extra cost.

*Registered Trade Mark

Sparkling Red Pearl Illustrated

LUDWIG

SUPER CLASSIC PARADE DRUMS



No. 965 —12" x 15"



No. 972P—12" x 15"



No. 979 —10" x 28"
(Sling Included)

Ludwig SUPER CLASSIC parade drums have long been the choice of the nation's leading musical organizations. The reasons . . . Ludwig's attention to detail in design, materials and craftsmanship. Now Ludwig provides added value to this popular line with new ACOUSTI-PERFECT shell design and hot clear lacquer interior finish. Both exclusive features provide a finer drum tone with more resonance and power.

Ludwig's three ply laminated shells are lightweight for easy carrying, yet are the strongest available. Solid rock-maple glue rings provide added protection against warping. All models supplied with glistening triple chrome-plated hardware. Sticks, beaters and slings, included.

CLASSIC SNARE DRUMS

| | | |
|------------------------------------------------------------|---|---------|
| No. 970 —10" x 14" Choice of Lacquer or Mahogany | } | \$88.50 |
| No. 976 —10" x 15" Choice of Lacquer or Mahogany | | |
| No. 972 —12" x 15" Choice of Lacquer or Mahogany | } | 100.00 |
| No. 973 —12" x 16" Choice of Lacquer or Mahogany | | |
| No. 970P—10" x 14" Choice of Pearl finishes | } | 103.00 |
| No. 976P—10" x 15" Choice of Pearl finishes | | |
| No. 972P—12" x 15" Choice of Pearl finishes | | 118.50 |
| Classic throw-off, extra | | \$7.50 |
| Gut snares, extra | | 4.00 |
| Two-tone wire-gut snares, extra | | 5.00 |

Wood hoops can be supplied at same price. Specify if desired.

CLASSIC TENOR DRUMS

| | |
|------------------------------------------------------------|----------|
| No. 965 —12" x 15" Choice of Lacquer or Mahogany | \$100.00 |
| No. 967 —12" x 17" Choice of Lacquer or Mahogany | 103.50 |
| No. 965P—12" x 15" Choice of Pearl finishes | 118.50 |
| No. 967P—12" x 17" Choice of Pearl finishes | 122.00 |

If plain or inlaid wood hoops desired on above, specify.

CLASSIC SCOTCH BASS DRUMS

| | |
|------------------------------------------------------------|----------|
| No. 978 —10" x 26" Choice of Lacquer or Mahogany | \$136.00 |
| No. 979 —10" x 28" Choice of Lacquer or Mahogany | 146.00 |
| No. 977 —10" x 30" Choice of Lacquer or Mahogany | 156.50 |
| No. 978P—10" x 26" Choice of Pearl finishes | 160.00 |
| No. 979P—10" x 28" Choice of Pearl finishes | 170.00 |
| No. 977P—10" x 30" Choice of Pearl finishes | 181.00 |

Pearl inlaid counterhoops are standard on all pearl models. Available at \$7.50 extra on mahogany or lacquer drums. Leg rests available at extra cost.

Illustrated in Sparkling Blue Pearl

PARADE MASTER PARADE DRUMS



No. 3210P—12" x 15"

No. 3202P—12" x 15"



No. 3220P—10" x 28"
(Sling Included)

The popular PARADE MASTER line of drums features the modern center mounted separate tension casings designed for full tension control of each head separately. Ludwig's exclusive ACOUSTI-PERFECT shell design and hot clear lacquer interior finish provide a finer drum tone with extra resonance and power without distortion. Triple-flanged hoops, instant snare throw-off and matched heads add to the high quality of this line.

Parade Master models are available in any combination of sparkling finishes at the same price as standard pearl. When ordering, specify outer color first, inner color second. All models supplied with triple chrome-plated hardware. Sticks, slings and beaters included at no extra charge. Leg rests available at slight additional cost; if desired, specify by model number.

Illustrated in Multi-Sparkle Silver and Black Pearl



Pearl inlaid counterhoops are standard on all pearl models. Available at \$7.50 extra on mahogany or lacquer drums. Leg rests available at extra cost.

PARADE MASTER SNARE DRUMS

| | |
|-------------------------------------------------------------|------------|
| No. 3092 —10" x 14" Choice of Lacquer or Mahogany | } \$ 84.00 |
| No. 3200 —10" x 15" Choice of Lacquer or Mahogany | |
| No. 3202 —12" x 15" Choice of Lacquer or Mahogany | } 95.50 |
| No. 3203 —12" x 16" Choice of Lacquer or Mahogany | |
| No. 3092P—10" x 14" Choice of Pearl finishes | } \$ 98.50 |
| No. 3200P—10" x 15" Choice of Pearl finishes | |
| No. 3202P—12" x 15" Choice of Pearl finishes | 115.00 |
| Classic throw-off | \$ 7.50 |
| Gut snares, extra | 4.00 |
| Two-tone wire-gut snares, extra | 5.00 |

If wood hoops desired, specify.

PARADE MASTER TENOR DRUMS

| | |
|-------------------------------------------------------------|----------|
| No. 3210 —12" x 15" Choice of Lacquer or Mahogany | \$ 95.50 |
| No. 3211 —12" x 17" Choice of Lacquer or Mahogany | 98.50 |
| No. 3210P—12" x 15" Choice of Pearl finishes | 115.00 |
| No. 3211P—12" x 17" Choice of Pearl finishes | 118.00 |

If plain or inlaid wood hoops desired on above, specify.

PARADE MASTER SCOTCH BASS DRUMS

| | |
|-------------------------------------------------------------|------------|
| No. 3214 — 8" x 26" Choice of Lacquer or Mahogany | } \$130.00 |
| No. 3218 —10" x 26" Choice of Lacquer or Mahogany | |
| No. 3215 — 8" x 28" Choice of Lacquer or Mahogany | } 140.00 |
| No. 3220 —10" x 28" Choice of Lacquer or Mahogany | |
| No. 3221 —10" x 30" Choice of Lacquer or Mahogany | 151.00 |
| No. 3214P— 8" x 26" Choice of Pearl finishes | 154.00 |
| No. 3218P—10" x 26" Choice of Pearl finishes | } 165.00 |
| No. 3215P— 8" x 28" Choice of Pearl finishes | |
| No. 3220P—10" x 28" Choice of Pearl finishes | } 175.00 |
| No. 3221P—10" x 30" Choice of Pearl finishes | |

LUDWIG



No. 3061—10" x 14"

No. 3065—10" x 15"



No. 3097—10" x 28"
(Sling Included)

Illustrated in Blue and White Multi-Color Lacquer.

STADIUM MODEL PARADE DRUMS

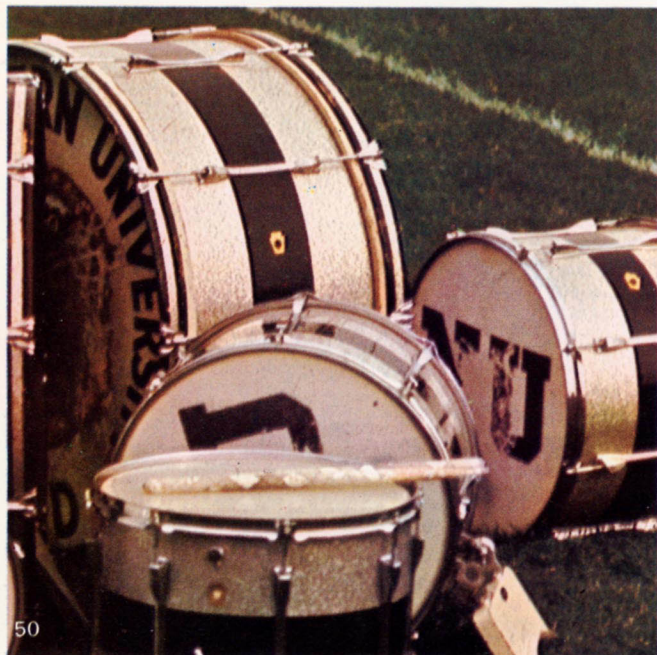

Snappy single tension STADIUM MODEL parade drums offer the finest quality available in the low price field. New ACOUSTI-PERFECT shell design and hot clear lacquer interior spray are extra value features offered only by Ludwig. Full drop throw-off strainer provides instant snare adjustment to any desired tone or response. Equipped with sturdy center supports and streamlined tension hooks for fine head tensioning, all models are supplied with glistening triple chrome-plated hardware and in either mahogany, lacquer, or multi-color lacquer finishes. Sticks, beaters and slings, included. Plain hoops are standard; pearl inlaid hoops available at \$3.50 extra on parade and tenor drums, \$7.50 extra for bass drums. Not supplied in pearl finishes. Leg rests available at extra cost.

STADIUM MODEL SNARE DRUMS

- No. 3061—10" x 14" Choice of Lacquer or Mahogany, Eight Rods... \$55.00
- No. 3062—10" x 14" Choice of Lacquer or Mahogany, Six Rods... 51.00
- No. 3071—12" x 15" Choice of Lacquer or Mahogany, Eight Rods... 63.50

STADIUM MODEL TENOR DRUMS

- No. 3065—10" x 15" Choice of Lacquer or Mahogany... \$55.00

STADIUM MODEL BASS DRUMS

- No. 3094—8" x 26" Choice of Lacquer or Mahogany... } \$105.00
- No. 3096—10" x 26" Choice of Lacquer or Mahogany... } \$105.00
- No. 3095—8" x 28" Choice of Lacquer or Mahogany... } 123.00
- No. 3097—10" x 28" Choice of Lacquer or Mahogany... } 123.00
- No. 3098—10" x 30" Choice of Lacquer or Mahogany... 140.00
- Pearl Inlaid hoops extra... \$7.50



PREP MODEL

Traditional Ludwig quality craftsmanship and the finest of materials are combined in producing the popular PREP MODEL parade drums. These superb marching models are designed for the beginning drummer at an economical price. The three ply laminated shell is firmly reinforced with hard rock-maple glue rings. Solid maple counterhoops are tensioned by six single tension key rods. Modern contour double claw hooks provide even head tension. Instant throw-off strainer offers finger-tip snare tension adjustment. Sticks and slings included.

Here is real value in a low price student line instrument. Available in either lacquer or mahogany finish.

No. 3062—10" x 14" PREP MODEL, chrome hardware \$51.00



CUB MODEL

The CUB MODEL is designed for use by youngsters of Grade School age and offers fine quality in an economy line. Three ply laminated shell is reinforced with rock-maple glue rings. Six single tension key rods and contour double claw hooks provide even head tension. Single screw snare strainer allows full snare control. Solid maple counterhoops in natural finish add to the lasting beauty of this model. Sticks and slings included. Available in mahogany finish only.

No. 2440—9" x 13" CUB MODEL, chrome hardware \$42.00

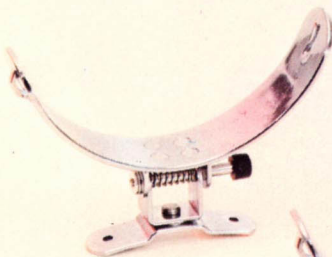

No. 478



No. 479

CLASSIC LEG RESTS

The Ludwig CLASSIC leg rest is designed to reduce leg fatigue and eliminates bruising knocks from the drum. The wide leg band is form fitting for comfortable carrying ease. Pin lock snaps leg rest in open or closed position.

Available in either rod mount or shell mount models. Easy to install on your present drum. Rod mount leg rest not recommended on Super Classic, High Tension or Super-Sensitive models. Designed for use with leather thongs if desired.

No. 478—Classic shell mount leg rest } \$6.00
No. 479—Classic rod mount leg rest }



Ludwig TOTAL PERCUSSION

TOTALLY MODERN IN SOUND and CONCEPT



LUDWIG . . . recognized by leading professional musicians, music educators and student percussionists as the world's standard in quality and dependability, continues to set new directions in TOTAL PERCUSSION. Through experience, imagination and craftsmanship, LUDWIG is always improving, always creating and always innovating to provide the music world with the finest in modern percussion instruments,

literature and educational concepts.

LUDWIG *means* TOTAL PERCUSSION . . . the most complete line of superior instruments, conceived, designed and built to meet the growing demands of contemporary composers and arrangers. No other percussion line offers so much, nor enjoys such universal use and acceptance.

LUDWIG ...presents new innovations
in pedal timpani



LUDWIG DRESDEN MODEL TIMPANI

NEW DRESDEN MODELS with DOUBLE RING KETTLE SUSPENSION

The new DRESDEN MODEL TIMPANI feature Ludwig's exclusive *double ring kettle suspension*, a free-floating, truly suspended kettle that offers greater resonance, projection and duration of tone at all dynamic levels. (See details of *double ring suspension* on pages 56 & 57)

Ludwig also introduces its new "profile" head design that extends the head collar beyond the edge of the kettle at just the right angle and distance for maximum definition of pitch fundamental. The DRESDEN MODEL features a precision pedal mechanism incorporating a system of reciprocal linkage which provides smooth and consistent foot action throughout the entire range. Unique "saw-tooth" clutch is engaged by side action clutch liner; locks pedal at any desired tone. Clutch lever may be shifted to either side of pedal footboard. Master tuning handle offers fractional tuning. WEATHER MASTER plastic heads, sticks and head protectors included.

POLISHED COPPER KETTLES

Sets:

No. 818—Set of 5: 20", 23", 26", 29", 32", DRESDEN

TIMPANI \$2,280.00B

No. 819—Set of 4: 23", 26", 29", 32", DRESDEN TIMPANI . . \$1,875.00B

No. 876—Set of 2: 26" and 29" DRESDEN TIMPANI . . \$ 925.00B

Individual Timpani:

No. 834—20" DRESDEN TIMPANI \$425.00B

No. 869—23" DRESDEN TIMPANI 450.00B

No. 812—26" DRESDEN TIMPANI 475.00B

No. 813—29" DRESDEN TIMPANI 500.00B

No. 867—32" DRESDEN TIMPANI 550.00B

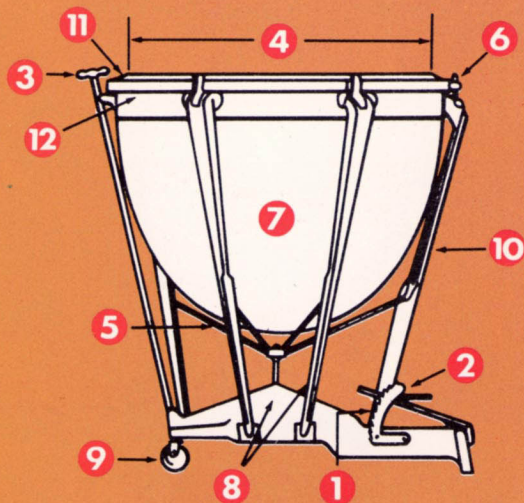

EXCLUSIVE FEATURES OF THE DRESDEN MODEL

1. Unique "Saw-Tooth" clutch locking pedal mechanism
2. Reversible clutch lever
3. Master tuning handle
4. 20", 23", 26", 29", 32" sizes standard
5. External tensioning
6. Eight key tension tuning rods
7. One-piece parabolic kettle, truly suspended
8. Lightweight aluminum struts and base
9. All-directional roller wheels with locks
10. Tension rods protected in support struts
11. New "Profile" head design
12. Double ring kettle suspension

**FIBERGLASS
KETTLES**

Sets:

- No. 1835—Set of 5: 20", 23", 26", 29", 32", DRESDEN TIMPANI..... \$1,800.00B
- No. 1836—Set of 4: 23", 26", 29", 32" DRESDEN TIMPANI.. \$1,450.00B
- No. 1876—Set of 2: 26" and 29" DRESDEN TIMPANI.. \$ 720.00B

All Timpani are priced with plastic heads.

Individual Timpani:

- No. 1869—23" DRESDEN TIMPANI..... \$350.00B
- No. 1847—26" DRESDEN TIMPANI..... 370.00B
- No. 1848—29" DRESDEN TIMPANI..... 385.00B
- No. 1867—32" DRESDEN TIMPANI..... 425.00B

**SATIN FINISH
ALUMINUM KETTLE**

- No. 1853—20" DRESDEN TIMPANI..... \$375.00B

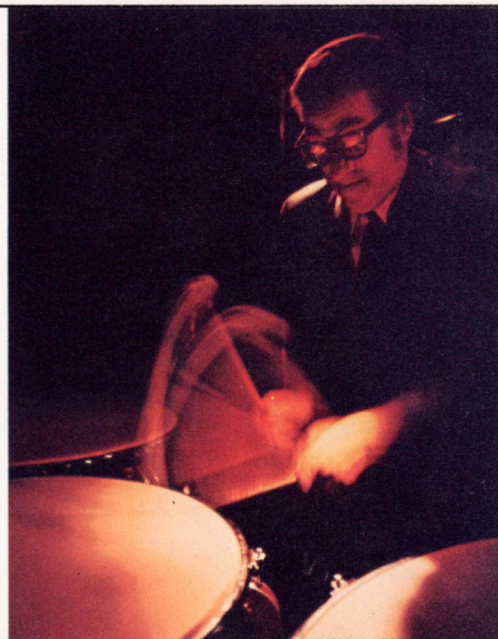

LUDWIG

innovators and manufacturers
of pedal tuned timpani since 1912



NEW PROFESSIONAL SYMPHONIC MODELS with DOUBLE RING KETTLE SUSPENSION

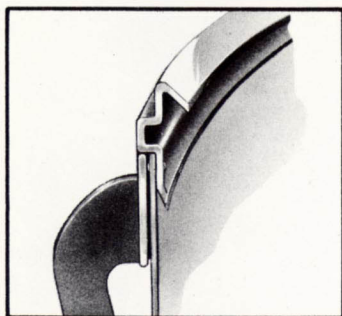

DOUBLE RING SUSPENSION

New "double ring" design completely suspends kettle in outer bracket ring.

LUDWIG: WORLD LEADER IN PEDAL TIMPANI, introduces its new PROFESSIONAL SYMPHONIC MODEL featuring *double ring kettle suspension*, a free floating suspended kettle that is entirely isolated from tuning mechanism. Kettle can be easily lifted out of outer suspension ring after removal of head.

The new PROFESSIONAL SYMPHONIC MODEL offers the greatest resonance, projection, and duration of tone at all dynamic levels available in any timpani today. New "profile" head design offers greater definition of fundamental pitch. Exclusive Ludwig *Balanced Action* pedal mechanism provides fast, effortless tuning required in today's contemporary music. Eight key tension

rods and suspension struts provide more accurate tuning. All mechanisms are placed on the outside of kettle assuring unbroken sound waves.

LUDWIG'S PROFESSIONAL SYMPHONIC MODELS are available in your choice of *polished copper* or *lightweight fiberglass* kettles. New *WEATHER MASTER* plastic heads, sticks and head protector included.

Compare feature for feature of this new Ludwig model with any other timpani available today . . . and most important, compare the full-bodied projected sound that only Ludwig offers.

All Timpani are priced with WEATHER MASTER plastic heads.

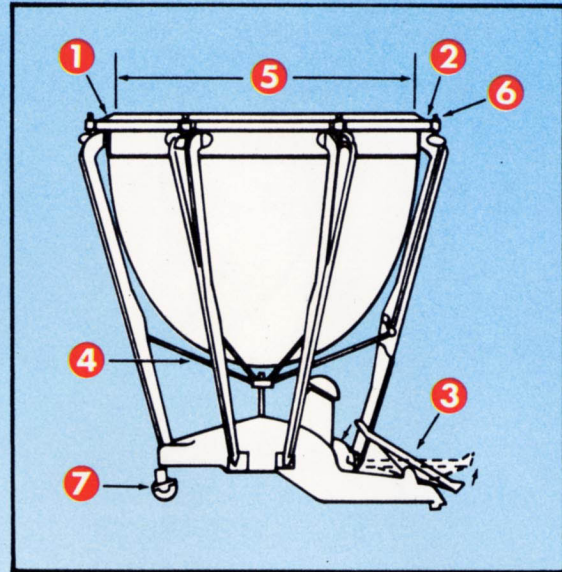

**EXCLUSIVE FEATURES of the
PROFESSIONAL SYMPHONIC MODEL**

- | | |
|------------------------------------|---------------------------------------------------|
| 1. NEW DOUBLE RING SUSPENSION | 5. LARGER KETTLE DIAMETERS FOR GREATER TONAL BODY |
| 2. PROFILE EXTENDED HEAD | 6. EIGHT KEY TENSION TUNING RODS |
| 3. BALANCED ACTION PEDAL MECHANISM | 7. ALL DIRECTIONAL ROLLER WHEELS |
| 4. EXTERNAL TENSION | |

For Tuning GAUGES see page 61.

POLISHED COPPER KETTLES

Sets:

- No. 816—Set of 5: 20", 23", 26", 29", 32" PROFESSIONAL SYMPHONIC TIMPANI \$2,160.00B
- No. 817—Set of 4: 23", 26", 29", 32" PROFESSIONAL SYMPHONIC TIMPANI \$1,780.00B
- No. 880—Set of 2: 26" and 29" PROFESSIONAL SYMPHONIC TIMPANI \$ 875.00B

Individual Timpani:

- No. 835—20" PROFESSIONAL SYMPHONIC TIMPANI . . . \$400.00B
- No. 879—23" PROFESSIONAL SYMPHONIC TIMPANI . . . 425.00B
- No. 814—26" PROFESSIONAL SYMPHONIC TIMPANI . . . 450.00B
- No. 815—29" PROFESSIONAL SYMPHONIC TIMPANI . . . 475.00B
- No. 878—32" PROFESSIONAL SYMPHONIC TIMPANI . . . 525.00B

FIBERGLASS KETTLES

Sets:

- No. 1837—Set of 5: 20", 23", 26", 29", 32" PROFESSIONAL SYMPHONIC TIMPANI \$1,710.00B
- No. 1838—Set of 4: 23", 25", 29", 32" PROFESSIONAL SYMPHONIC TIMPANI \$1,375.00B
- No. 1880—Set of 2: 26" and 29" PROFESSIONAL SYMPHONIC TIMPANI \$ 680.00B

Individual Timpani:

- No. 1854—20" PROFESSIONAL SYMPHONIC TIMPANI . . \$350.00B (Aluminum Kettle, Satin Finish)
- No. 1879—23" PROFESSIONAL SYMPHONIC TIMPANI . . 330.00B
- No. 1849—26" PROFESSIONAL SYMPHONIC TIMPANI . . 350.00B
- No. 1850—29" PROFESSIONAL SYMPHONIC TIMPANI . . 365.00B
- No. 1878—32" PROFESSIONAL SYMPHONIC TIMPANI . . 405.00B

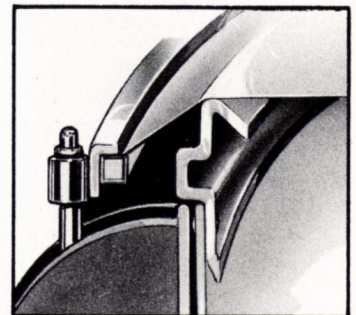

PROFILE COLLAR

New "profile collar" extends the head beyond the edge of kettle providing greater resonance and definition of pitch fundamental.

LUDWIG ... total quality in timpani



In all musical history, no other timpani has enjoyed such great popularity as the Ludwig STANDARD SYMPHONY Model. Today, leading musical organizations the world over feature the incomparable tone and response of these fine instruments.

Ludwig's famous Balanced Action pedal provides instant, trouble-free tuning. Six sturdy suspension struts support the deep parabolic kettles offering maximum kettle resonance. All-directional roller wheels provide easy portability and lock instruments into playing position. Solid, seamless kettles are available in either mirror-smooth, polished copper or lightweight Fiberglass. Metal parts, including rods and hoops are chrome plated. WEATHER MASTER plastic heads, sticks and fibre head protectors are included.

LUDWIG STANDARD SYMPHONY MODEL

Polished Copper Kettles

Sets:

- No. 798—Set of 5: 20", 23", 26", 29", 32"
STANDARD SYMPHONY TIMPANI. \$2,050.00B
- No. 799—Set of 4: 23", 26", 29", 32"
STANDARD SYMPHONY TIMPANI. 1,675.00B
- No. 891—Set of 2: 26" and 29"
STANDARD SYMPHONY TIMPANI. 825.00B

Individual Timpani:

- No. 836—20" STANDARD SYMPHONY TIMPANI..... \$385.00B
- No. 886—23" STANDARD SYMPHONY TIMPANI..... 400.00B
- No. 795—26" STANDARD SYMPHONY TIMPANI..... 425.00B
- No. 797—29" STANDARD SYMPHONY TIMPANI..... 450.00B
- No. 887—30" STANDARD SYMPHONY TIMPANI..... 480.00B
- No. 889—32" STANDARD SYMPHONY TIMPANI..... 500.00B

Fiberglass Kettles

Sets:

- No. 1839—Set of 5: 20", 23", 26", 29", 32"
STANDARD SYMPHONY TIMPANI. \$1,560.00B
- No. 1840—Set of 4: 23", 26", 29", 32"
STANDARD SYMPHONY TIMPANI. 1,245.00B
- No. 1890—Set of 2: 26" and 29"
STANDARD SYMPHONY TIMPANI. 620.00B

Individual Timpani:

- No. 1886—23" STANDARD SYMPHONY TIMPANI..... \$310.00B
- No. 1851—26" STANDARD SYMPHONY TIMPANI..... 320.00B
- No. 1852—29" STANDARD SYMPHONY TIMPANI..... 330.00B
- No. 1887—30" STANDARD SYMPHONY TIMPANI..... 340.00B
- No. 1889—32" STANDARD SYMPHONY TIMPANI..... 350.00B

Satin Finish Aluminum Kettle

- No. 1855—20" STANDARD SYMPHONY TIMPANI.. \$335.00B

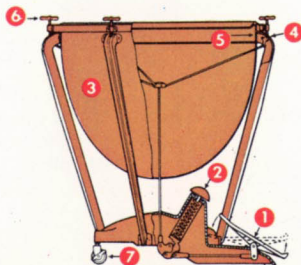

EXCLUSIVE FEATURES OF THE STANDARD SYMPHONY MODEL

1. Famous Ludwig Balanced Action pedal mechanism for fast, effortless tuning —located directly on the floor
 2. Balanced Action control knob and spring eliminates need for ratchets or clutch
 3. One-piece parabolic kettles for greater tone and resonance
 4. Bell cranks and links are built into struts for maximum protection
 5. Solid steel reinforcement band supports head tension, maintaining even head tone at all times
 6. Small low-set tension handles are easy to reach, yet not in way of sticks when playing
 7. All-directional roller wheels with built-in locks hold timpani in playing position
- All Timpani are priced with plastic heads.*

Long used by professional studio groups, university and school bands and orchestras, the UNIVERSAL Model was originally built by Wm. F. Ludwig, Sr. in 1919. It was designed and perfected for the discriminating professional, incorporating Mr. Ludwig's natural Balanced Action tuning mechanism, and has withstood the test of time and performance.

Tuning action is smooth and effortless, with floor level pedal which provides fast, accurate tone changes from seated or standing positions. Deep parabolic kettles assure superior tone and resonance throughout the entire range. All-directional roller wheels provide for quick position adjustment, yet lock in place when playing. Available with either polished or satin finish copper or Fiberglass kettles; rods and hoops are chrome plated. WEATHER MASTER plastic heads, sticks and fibre head protectors included.



**LUDWIG
UNIVERSAL MODEL**

Polished Copper Kettles

Sets:

- No. 993—Set of 5: 20", 23", 26", 29", 32"
UNIVERSAL TIMPANI \$1,820.00B
- No. 934—Set of 4: 23", 26", 29", 32"
UNIVERSAL TIMPANI 1,500.00B
- No. 935—Set of 2: 26" and 29"
UNIVERSAL TIMPANI 745.00B

Individual Timpani:

- No. 837—20" UNIVERSAL TIMPANI \$335.00B
- No. 894—23" UNIVERSAL TIMPANI 350.00B
- No. 930—26" UNIVERSAL TIMPANI 385.00B
- No. 932—29" UNIVERSAL TIMPANI 410.00B
- No. 895—30" UNIVERSAL TIMPANI 420.00B
- No. 864—32" UNIVERSAL TIMPANI 435.00B

Fiberglass Kettles

Sets:

- No. 1893—Set of 5: 20", 23", 26", 29", 32"
UNIVERSAL TIMPANI \$1,350.00B
- No. 1894—Set of 4: 23", 26", 29", 32"
UNIVERSAL TIMPANI 1,050.00B
- No. 1892—Set of 2: 26" and 29"
UNIVERSAL TIMPANI 520.00B

Individual Timpani:

- No. 1897—23" UNIVERSAL TIMPANI \$260.00B
- No. 1881—26" UNIVERSAL TIMPANI 270.00B
- No. 1882—29" UNIVERSAL TIMPANI 280.00B
- No. 1898—30" UNIVERSAL TIMPANI 290.00B
- No. 1863—32" UNIVERSAL TIMPANI 300.00B

Satin Finish Aluminum Kettle

- No. 1856—20" UNIVERSAL TIMPANI \$310.00B

All Timpani are priced with plastic heads.

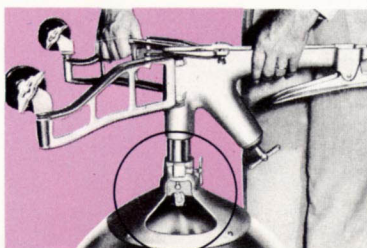

THE COMPLETELY PORTABLE TIMPANI

The UNIVERSAL Model features a detachable base, enabling kettle and pedal mechanism to be packed separately. When instruments are placed upside down, the ball and socket connection between main pull rod and pedal is readily accessible for fast set-up and dismantling. The wide-angle roller legs fold conveniently for packing.

LUDWIG

concert machine timpani

Ludwig combines quality with economy in offering the CONCERT MACHINE TIMPANI. Tuned by a single screw tuning mechanism, which is easily operated by a hand crank mounted near the playing surface, rapid tuning is achieved by merely turning the handle to the right to raise pitch or to the left to lower pitch. A full octave range is readily obtainable on each instrument. Legs telescope into kettle for easy packing.

Ludwig CONCERT MACHINE TIMPANI, with either copper or Fiberglass kettles, are designed for use in Junior High and Grade School organizations where budget and age of player are major factors. May be used as auxiliary instruments to an existing set of pedal timpani. WEATHER MASTER plastic heads, sticks and fibre head protectors included.

- Single Screw Tuning
- Full Octave Range
- Deep Parabolic Kettles
- Height and Angle Adjustment
- Removable Tuning Handle
- Chrome Hoops and Rods



EXTRA PORTABILITY

Legs retract compactly into kettle for ease of transport and offer complete height and playing angle adjustment. Ideal for traveling organizations as well as the "pit" drummer.



Note: 20" dia. kettle does not permit telescoping legs.

POLISHED COPPER KETTLES

Sets:

| | |
|----------------------------------------------------------------|-------------|
| No. 855—Set of 5: 20", 23", 26", 29", 32" MACHINE TIMPANI..... | \$1,300.00B |
| No. 856—Set of 4: 23", 26", 29", 32" MACHINE TIMPANI..... | 1,160.00B |
| No. 854—Set of 2: 26" and 29" MACHINE TIMPANI..... | 585.00B |

Individual Timpani:

| | |
|----------------------------------|------------|
| No. 848—20" MACHINE TIMPANI..... | \$ 250.00B |
| No. 872—23" MACHINE TIMPANI..... | 260.00B |
| No. 851—26" MACHINE TIMPANI..... | 290.00B |
| No. 853—29" MACHINE TIMPANI..... | 325.00B |
| No. 873—30" MACHINE TIMPANI..... | 340.00B |
| No. 865—32" MACHINE TIMPANI..... | 350.00B |

FIBERGLASS KETTLES

Sets:

| | |
|-----------------------------------------------------------------|-------------|
| No. 1895—Set of 5: 20", 23", 26", 29", 32" MACHINE TIMPANI..... | \$1,000.00B |
| No. 1896—Set of 4: 23", 26", 29", 32" MACHINE TIMPANI..... | 795.00B |
| No. 1870—Set of 2: 26" and 29" MACHINE TIMPANI..... | 395.00B |

Individual Timpani:

| | |
|-----------------------------------|------------|
| No. 1874—23" MACHINE TIMPANI..... | \$ 175.00B |
| No. 1883—26" MACHINE TIMPANI..... | 200.00B |
| No. 1884—29" MACHINE TIMPANI..... | 215.00B |
| No. 1875—30" MACHINE TIMPANI..... | 230.00B |
| No. 1866—32" MACHINE TIMPANI..... | 245.00B |

SATIN FINISH ALUMINUM KETTLE

| | |
|-----------------------------------|------------|
| No. 1857—20" MACHINE TIMPANI..... | \$ 225.00B |
|-----------------------------------|------------|



All Timpani are priced with WEATHER MASTER plastic heads.

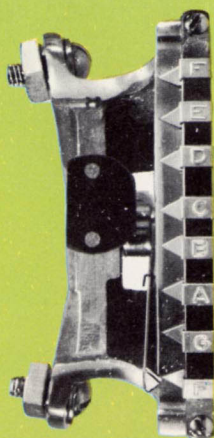
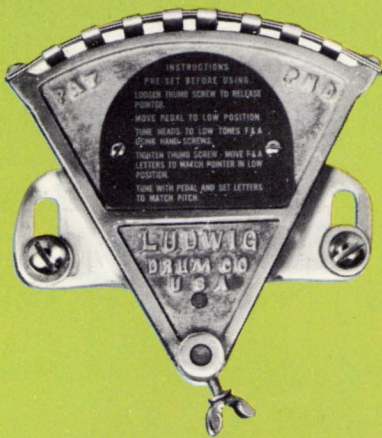

TIMPANI TUNING GAUGE

The exclusive Ludwig tuning gauge is essential in the performance of rapid changes in tuning and is ideal for use by the school and professional timpanist. This handy accessory measures the movement of the counterhoop and transfers this into accurate pitch readings by means of a pointer hand. The letters are movable on a sliding track since the gauge must be hand set before each use when using calfskin heads. They may be mounted on any make or model and complete instructions with drawing accompany each pair of gauges. They are extremely accurate when used with LUDWIG plastic heads.

TUNING GAUGES

| | |
|---------------------|---------------------|
| No. 1060—20" | No. 1062—25" or 26" |
| No. 1061—23" | No. 1063—28" or 29" |
| No. 1064—30" or 32" | |
| Each.....\$27.50 | |

TIMPANI TRUNKS AND COVERS

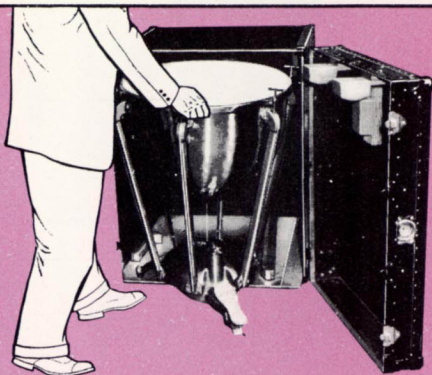

SYMPHONY TIMPANI TRUNKS

Professional quality timpani trunks are reinforced and padded to offer maximum protection when traveling. Galvanized steel floor allows timpani to be rolled in for quick packing.

| | |
|-----------------------------------------------------------------------------|-------------|
| No. 821-1—TRUNK FOR 20" DRESDEN TIMPANI, each..... | } \$210.00G |
| No. 821-2—TRUNK FOR 20" PROFESSIONAL TIMPANI, each..... | |
| No. 821-3—TRUNK FOR 20" SYMPHONY TIMPANI, each..... | |
| No. 822-1—TRUNK FOR 23" DRESDEN TIMPANI, each..... | |
| No. 822-2—TRUNK FOR 23" PROFESSIONAL TIMPANI, each..... | |
| No. 822-3—TRUNK FOR 23" SYMPHONY TIMPANI, each..... | |
| No. 823-3—SET OF TRUNKS FOR 25" AND 28" SYMPHONY TIMPANI, per pair..... | \$417.50G |
| No. 824-1—SET OF TRUNKS FOR 26" AND 29" DRESDEN TIMPANI, per pair..... | } \$430.00G |
| No. 824-2—SET OF TRUNKS FOR 26" AND 29" PROFESSIONAL TIMPANI, per pair..... | |
| No. 824-3—SET OF TRUNKS FOR 26" AND 29" SYMPHONY TIMPANI, per pair..... | |
| No. 825-1—TRUNK FOR 30" DRESDEN TIMPANI, each..... | } \$215.00G |
| No. 825-2—TRUNK FOR 30" PROFESSIONAL TIMPANI, each..... | |
| No. 825-3—TRUNK FOR 30" SYMPHONY TIMPANI, each..... | |
| 826-1—TRUNK FOR 32" DRESDEN TIMPANI, each..... | } \$220.00G |
| No. 826-2—TRUNK FOR 32" PROFESSIONAL TIMPANI, each..... | |
| No. 826-3—TRUNK FOR 32" SYMPHONY TIMPANI, each..... | |



UNIVERSAL AND MACHINE TIMPANI TRUNKS

Top quality, heavy-duty construction offers safety for your timpani when in transit. Suspension sling holds kettle—pedal detaches and is securely protected with supporting blocks.

| | |
|--------------------------------------------------------------------------|-----------|
| No. 821-4—TRUNK FOR 20" UNIVERSAL TIMPANI, each..... | \$160.00G |
| No. 821-5—TRUNK FOR 20" MACHINE TIMPANI, each..... | 170.00G |
| No. 822-4—TRUNK FOR 23" UNIVERSAL TIMPANI, each..... | 162.50G |
| No. 822-5—TRUNK FOR 23" MACHINE TIMPANI, each..... | 172.50G |
| No. 823-4—SET OF TRUNKS FOR 25" AND 28" UNIVERSAL TIMPANI, per pair..... | 327.50G |
| No. 823-5—SET OF TRUNKS FOR 25" AND 28" MACHINE TIMPANI, per pair..... | 345.00G |
| No. 824-4—SET OF TRUNKS FOR 26" AND 29" UNIVERSAL TIMPANI, per pair..... | 340.00G |
| No. 824-5—SET OF TRUNKS FOR 26" AND 29" MACHINE TIMPANI, per pair..... | 357.50G |
| No. 825-4—TRUNK FOR 30" UNIVERSAL TIMPANI, each..... | 167.50G |
| No. 825-5—TRUNK FOR 30" MACHINE TIMPANI, each..... | 177.50G |
| No. 826-4—TRUNK FOR 32" UNIVERSAL TIMPANI, each..... | 172.50G |
| No. 826-5—TRUNK FOR 32" MACHINE TIMPANI, each..... | 182.50G |

FIBRE HEAD PROTECTORS

| | |
|-----------------|--------------|
| No. 1070—20" | No. 1074—28" |
| No. 1071—23" | No. 1075—29" |
| No. 1072—25" | No. 1076—30" |
| No. 1073—26" | No. 1077—32" |
| Each.....\$2.65 | |



FULL DROP TIMPANI COVERS

Full drop covers provide maximum protection for your timpani when not in use. The 28" drop skirt keeps out dirt and dust and prevents unauthorized persons from tampering with the instrument.

| | |
|-----------------------------------------------------|---------|
| No. 831—20" FULL DROP COVER, each..... | \$14.00 |
| No. 882—23" FULL DROP COVER, each..... | 15.25 |
| No. 896—25" AND 28" FULL DROP COVERS, per pair..... | 36.00 |
| No. 884—26" AND 29" FULL DROP COVERS, pair..... | 37.75 |
| No. 883—30" FULL DROP COVER, each..... | 21.00 |
| No. 881—32" FULL DROP COVER, each..... | 21.75 |

DURA HYDE SHALLOW DROP COVERS

| | |
|------------------|-----------|
| No. 196—20"..... | } \$14.00 |
| No. 197—23"..... | |
| No. 198—26"..... | |
| No. 199—29"..... | } \$15.75 |
| No. 200—32"..... | |

LUDWIG LATIN-AMERICAN INSTRUMENTS

ultimate perfection in Latin-American sounds



LUDWIG TUNABLE CONGA DRUMS

Ludwig's TUNABLE CONGA DRUM design features deep tapered shell for authentic tone and resonance. Standard key tuning provides complete control of head tension with a deep seated collar assuring a clear playing surface for hands or mallets. Ideal for the school percussion section or ensemble. Supplied with sling, carrying hook and plastic heads unless specified, otherwise. Sturdy, fully adjustable, chrome plated stand for twin and single conga drums, available as illustrated. Choice of Mackintosh or Dura-Hyde zipper cover or fibre case available at extra cost.

- No. 2371L**—SINGLE TUNABLE CONGA DRUM, choice of lacquer finishes with sling and carrying hooks . . . **\$70.00**
- No. 2371P**—SINGLE TUNABLE CONGA DRUM, choice of pearl finishes with sling and carrying hooks . . . **84.00**
- No. 2373L**—SINGLE TUNABLE CONGA DRUM, choice of lacquer finishes mounted with legs **90.00**
- No. 2373P**—SINGLE TUNABLE CONGA DRUM, choice of pearl finishes mounted with legs **109.00**
- No. 2377L**—TWIN TUNABLE CONGA DRUMS, with dual mount stand, choice of lacquer finishes **152.00**
- No. 2377P**—TWIN TUNABLE CONGA DRUMS, with dual mount stand, choice of pearl finishes **\$177.00**

- No. 2374L**—CONGA DRUM, only with clip attachment and stop stud **70.00**
- No. 2374P**—CONGA DRUM only, with clip attachment and stop stud **84.00**
- No. 5022** —Legs for Single Conga Drum, complete. **16.00**
- No. 1344** —Dual Mount Stand for Twin Conga Drum, complete **20.00**
- No. 69** —Mackintosh zipper cover for carrying single conga drum without legs **15.00**
- No. 286** —Dura-Hyde single conga drum cover **22.50**
- No. 8888** —Fibre case for carrying single conga drum **31.00**



LUDWIG TUNABLE BONGOS

Ludwig professional model TUNABLE BONGOS are supplied with 6" and 8" head diameters in 5½" shell depths. Sturdy, laminated, reinforced shells are built for extreme high tension required for authentic bongo sound. Conventional key tuning provides instant head tensioning with the least amount of effort. Ludwig bongos are ideal for concert use with finger or stick performance and mounted with plastic heads, unless specified otherwise. Sturdy, fully adjustable chrome plated stand mount, illustrated, available as listed; fibre case available at extra cost.

No. 2358L—TUNABLE BONGOS, choice of lacquer finishes . \$60.00

No. 2358P—TUNABLE BONGOS, choice of pearl finishes . . . \$73.00

No. 2357L—TUNABLE BONGOS, choice of lacquer finishes with floor stand and clip attachment \$76.00

No. 2357P—TUNABLE BONGOS, choice of pearl finishes with floor stand and clip attachment \$89.00

No. 8182—Fibre case for tunable Bongos \$18.00

No. 1346—Bongo floor stand with attachment \$16.00

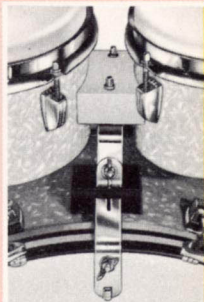

Ludwig Bongos can be mounted on an outfit bass drum in easy playing position for sticks or hands with a hoop holder.

No. 46—Hoop Mount Bongo Holder \$7.00

TIMBALE STICKS

No. 311—TIMBALE STICKS, 15" x ¾", 6 pair \$2.25

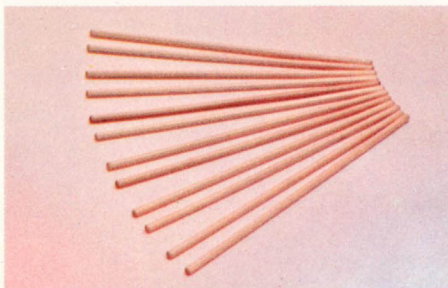

LUDWIG LATIN TIMBALES

Ludwig's authentic Latin-style TIMBALES have the true Latin sound so important for today's popular rhythms. Shells are beautifully finished in brass, copper or chrome plate, highly buffed and polished to a gleaming luster. Sizes: 13" and 14" head diameters with 6½" shell depths. Supplied complete with adjustable folding stand for seated or standing playing positions. Mounted with plastic heads and triple-flanged counterhoops, unless specified otherwise. Mackintosh cover or fibre case to hold both timbales, extra.

No. 2351—TIMBALES, copper finish, stand and plastic heads. \$134.00

No. 2345—TIMBALES only—copper finish, plastic heads, clip attachments and stop studs. 118.00

No. 2352—TIMBALES, copper finish, stand and calf heads* . . . 148.00

No. 2346—TIMBALES only—copper finish, calf heads* and clip attachments. 132.00

No. 2353—TIMBALES, brass finish, stand and plastic heads. . . 134.00

No. 2347—TIMBALES only—brass finish, plastic heads, clip attachments and stop studs. 118.00

No. 2354—TIMBALES, brass finish, stand and calf heads* . . . 148.00

No. 2348—TIMBALES only—brass finish, calf heads* and clip attachments. 132.00

No. 2359—TIMBALES, chrome finish, stand and plastic heads 144.00

No. 2349—TIMBALES only—chrome finish, plastic heads, clip attachments and stop studs. 128.00

No. 2360—TIMBALES, chrome finish, stand and calf heads* . . . 162.00

No. 2350—TIMBALES only—chrome finish, calf heads* and clip attachments. 146.00

No. 1348—Timbale stand only, chrome. 16.00

No. 65 —Mackintosh cover to hold both timbales. 8.00

No. 7150—Fibre case to hold both timbales. 16.10

**An exclusive design combines flesh hoop and counterhoop into one, providing instant key tuning.*

TIMBALE COW BELL HOLDERS

Single and double cow bell holders for timbales attach to collar tension rods . . . holds cow bell rigidly in playing position.

No. 126-1—Single Cow Bell Holder. \$1.75

No. 127-1—Double Cow Bell Holder. 3.00

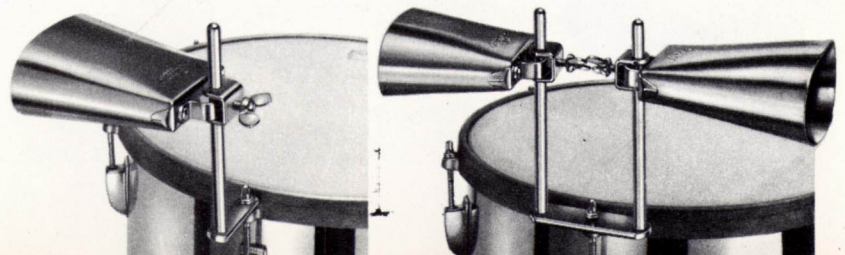

LUDWIG... *the new sounds of Latin percussion*



GOLDEN TONE COW BELL

A heavier, harder alloy gives Ludwig's Cow Bells the ideal sound for today's sophisticated Latin rhythms. Fully welded seams guarantee rich, bright effects. Finished in golden bronze plating.

No. 128—4" COW BELL \$5.50
No. 129—5" COW BELL \$7.00

special effect cow bells

THE BLACK BEAUTY CHA-CHA BELL



An effective all-around cow bell, this model is most often used for Cha-Cha rhythms. Exclusive SONI-CURVE surface produces maximum volume. 6" overall length.

No. 2388—BLACK BEAUTY COW BELL . . . \$8.50

TIMBALE COW BELL

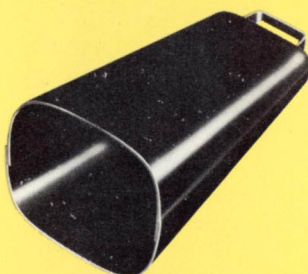

Also featuring the exclusive SONI-CURVE, this model, because of its big, solid sound is most frequently preferred for driving, up-tempos beats. 9" overall length.

No. 2389—TIMBALE COW BELL \$12.00

BONGO (HAND) COW BELL

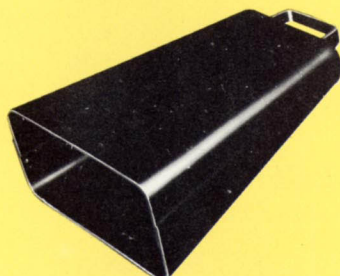

Of a heavier gauge steel, this cow bell produces a very deep sound. It is designed to be played handheld with Bongo Cow bell Beater. 9" overall length.

No. 2390—BONGO COW BELL \$15.00

MAMBO COW BELL



A sharply defined, raised center makes this model extremely versatile. It is capable of many effects and its unique design produces a maximum volume.

No. 2391—MAMBO COW BELL \$12.00

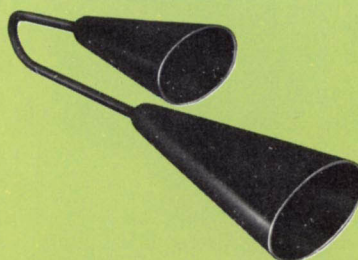

AGOGO BELLS

From Bahia in Brazil comes this unique percussion sound. Two richly toned bells, pitched approximately a third apart are played by any variety of strikers to produce authentic and exciting effects. They are particularly favored by Latin-style drummers for "hard" Sambas and Batucata, and also lend themselves well to up-tempo Cuban rhythms.

No. 2387—AGOGO BELLS \$19.00

AGOGO BELLS MOUNTING BRACKET

For mounting Agogo Bells to bass drum or timbales.

No. 2387-1—AGOGO BELL MOUNTING BRACKET \$3.75

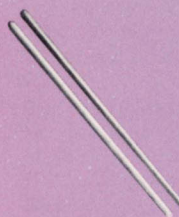

COW BELL STICKS

Just the right weight, length and diameter for proper tone and playing ease of modern cow bell rhythms. Solid hickory sticks.

No. 312—COW BELL STICKS, pair. \$1.80



COW BELL HOLDER

Sturdily constructed cow bell holder mounts directly on bass drum counter hoop or edge of trap table. Main shaft is 6" high for use with small bass drums. "U" clamp holds bell firmly in position.

No. 133—COW BELL HOLDER \$3.00

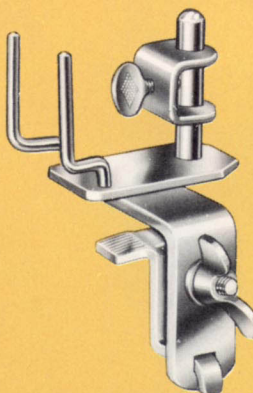

BELL-BLOCK HOLDER

The ideal holder for cow bell and wood block combination. Mounts directly on bass drum hoop or edge of trap table.

No. 1323—BELL-BLOCK HOLDER \$3.50

Today Latin rhythms are enjoying a popularity like never before. And for the most authentic of Latin Sounds, Ludwig presents these special instruments.

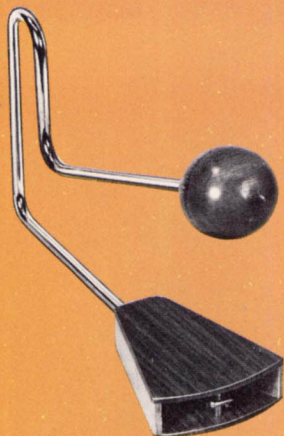

VIBRA-SLAP

The Vibra-Slap delivers the same sound as the "Jawbone", but with a much greater consistency and strength. The unique sound it produces is not necessarily confined to Latin music but also fits in with "rock" and other pop styles. Lasting construction.

- No. 2383—VIBRA-SLAP (Small) \$ 9.50
- No. 2384—VIBRA-SLAP (Large) \$11.00

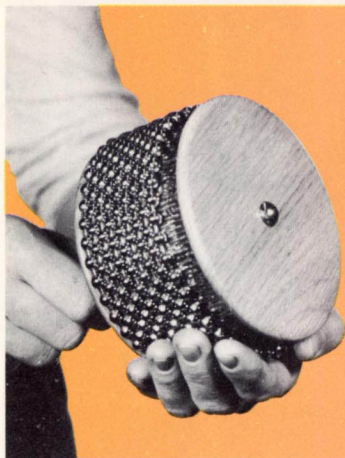

AFUCHE (CABASA)

The AFUCHE provides another unusual Brazilian rhythm sound. Metal beads surrounding a simulated gourd produce a tight, dry Cabasa sound with extra "highs" that provide a totally different effect.

- No. 2380—AFUCHE, Small \$14.95
- No. 2381—AFUCHE, Medium \$16.75
- No. 2382—AFUCHE, Large \$18.50



AFRICAN CLAVES

Featuring a semi-hollow design, these Claves produce a tone much richer and deeper than regular claves. They have a carrying power that easily cuts through even the biggest band's sound.

- No. 2385—AFRICAN CLAVES, Small, pr. \$3.95
- No. 2386—AFRICAN CLAVES, Large, pr. \$6.95



METAL TUBO (SHAKER)

Popular in Brazil, the Metal Tubo is a hand held metal shaker filled with balanced shot. The effect it produces is similar to the Ka-Me-So but with a crisper, more definite sound.

- No. 2392—METAL TUBO, Small \$2.00
- No. 2393—METAL TUBO, Large \$2.75

standard percussion

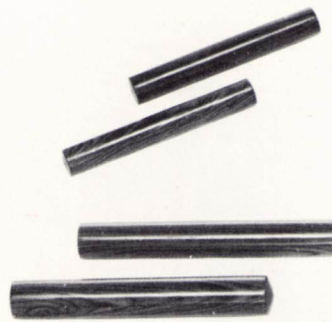

CLAVES

These top quality claves produce an authentic sound so important to today's popular Latin rhythm. Made of hand turned rosewood, lacquered and polished to a gleaming luster, these claves will not CRACK OR SPLIT with ordinary care.

- No. 2361—CLAVES, Small, per pair \$2.75
- No. 2368—CLAVES, Medium, per pair \$3.25

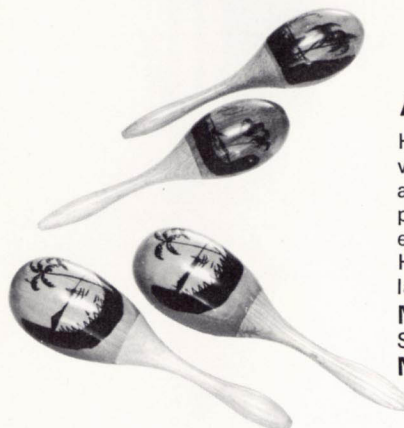

MARACAS

Hand turned from choice wood, and filled with balanced shot. These Maracas provide a clear, high-pitched extension of the Latin beat. Hand painted design and lacquer finish.

- No. 2364—MARACAS, Small, per pair \$4.00
- No. 2365—MARACAS, Medium, per pair \$5.00



GUIRO

Ludwig's Professional Quality hand carved GUIRO produces the authentic Latin tone. Evenly spaced deep grooves provide clear tone and resonance. Supplied with quality scraper.

- No. 2366—GUIRO, Small \$6.00
- No. 2367—GUIRO, Medium \$7.50



KA-ME-SO

Producing a sound similar to the Maracas, the KA-ME-SO also is capable of long rolls for legato passages. Played by turning end to end or with a gentle rolling motion. Hand painted and polished.

- No. 2369—KA-ME-SO \$7.50

Musser the quality standard
in mallet percussion: **VIBES**



CENTURY VIBE
an instrument of ultimate beauty in tone and design

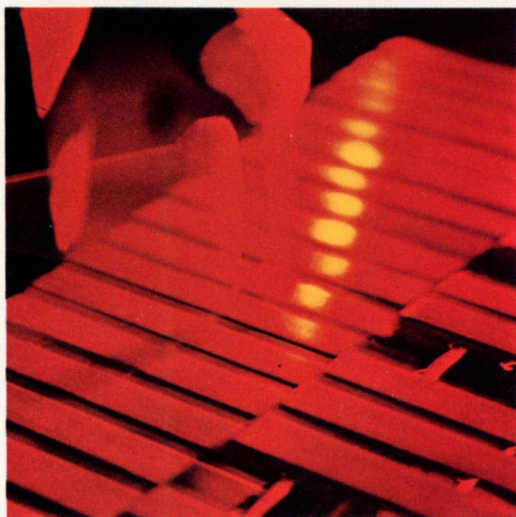

The CENTURY is truly the masterpiece among vibraphonic instruments, selected for its superior quality by leading vibe artists throughout the world. Some of the features found on the CENTURY are: thicker and wider, more resonant bars, expertly tuned to A-440, enclosed motor and belt pulleys, self-aligning pulsator shafts, arched-mitered resonators and lifetime variable speed motor with conveniently located control panel which houses the silent Mercury switch, on-off pilot light and speed control.

The CENTURY is finished in handsome gun-metal black ends and rails; keyboard and resonators are gold anodized. Solid end pieces are covered with new scuff resistant material in matching black. Packs into 5 cases for transport. Supplied with fleece lined vinyl cover and three pairs of suitable mallets; carrying cases extra.

SPECIFICATIONS:

Keyboard: 3 octaves, F³ to F⁶
Bars: 2¼" x ½" to 1½" x ½"
Motor: 115 Volts, 60 cycle AC
Height: 33½" — Length: 57"
Width: low end: 29½" — high end: 14½"
Weight: 140 lbs.

No. M-75—CENTURY VIBE..... \$1400.00B

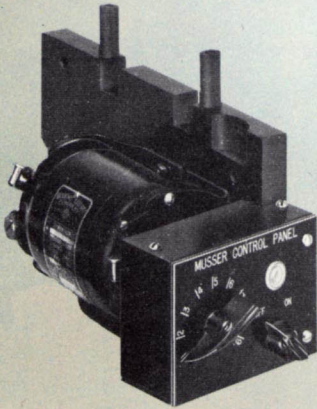

**MUSSER
VIBE MOTOR**

The Musser Vibe motor, standard on the Century and Pro Vibes, is the finest available . . . offering quiet, trouble-free performance with a minimum of maintenance. The induction Capacitor-type motor eliminates brushes and arcing; bakelite gear and Mercury switch provide quiet operation with no pick-up interference for recording; capacitor and rheostat govern speed of motor. 115 volts; 60 cycle AC; 1/140 HP; rubber mounted for minimum noise level.



PRO VIBE

The Musser PRO VIBE is an ingenious combination of brilliant sound and portability. Here are the features that make the Musser PRO VIBE the new standard of quality in portable vibraphones: full-range keyboard; wider, more resonant bars, perfectly tuned to A-440; enclosed motor and belt pulleys; lifetime variable speed motor; self-aligning pulsator shaft, and arched-mitered resonators. Legs and crossbars of the frame are square extra hard aluminum, finished with durable black crackle coating. Guards are gleaming polished aluminum. Packs in only 3 cases! Fleece lined vinyl cover and three pairs of suitable mallets included; cases extra.

SPECIFICATIONS:

Keyboard: 3 octaves, F³ to F⁶
 Bars: 2¼" x ½" to 1½" x ½"
 Motor: 115 volts, 60 cycle AC
 Height: 34¼" —Length: 56"
 Width: low end: 30" —high end: 15"
 Weight: 95½ lbs.

No. M-55—PRO VIBE \$1145.00B

**ONE-NIGHTER
PORTABLE VIBE**

The Musser ONE-NITER combines easy portability with beautiful appearance, exquisite tone quality and perfect intonation. The brilliant tone of the portable vibe is full bodied and rich, with unusual carrying power. The keyboard bars are finely tuned to A-440 and have a smooth satin-silver finish. The frame is soft black, beautifully set with gleaming polished aluminum guards. Legs and crossbar are square, extra hard aluminum for light weight, attractively finished with durable crackle coating. Arched resonators are individually tuned and are completely insulated from carriage.

The ONE-NITER is available with either single speed or variable speed motor. Packs easily into three cases. Fleece lined vinyl cover and three pairs of suitable mallets included; cases extra.

SPECIFICATIONS:

Keyboard: 3 octaves, F³ to F⁶
 Bars: 1½" x ½"
 Motor: 110 Volts, 50-60 cycle AC
 Height: 34¼" —Length 47"
 Width: low end: 29¾" —high end: 13½"
 Weight: 78¼ lbs.

No. M-48—ONE-NITER VIBE, single speed . \$775.00B
No. M-45—ONE-NITER, variable speed . . . \$875.00B



MUSSER the quality standard
 in mallet percussion: **MARIMBAS**



**CONCERT GRAND/CENTURY
 MARIMBAS**

Two magnificent models of unequalled perfection . . . here are truly instruments of ultimate perfection in designed beauty and tonal performance where quality craftsmanship is obvious in every detail. The new "wide bar" CENTURY features full four octave keyboard of genuine Honduras rosewood, expertly tuned to A-440. The CONCERT GRAND model extends the range to low A, providing the only 4½ octave marimba available in the world today. The added B, B^b and A expand the versatility of this superior "artist's" instrument.

Exclusive MUSSER design offers ease of setting up and transport. The ends and rails are hand finished in striking gun-metal black. The keyboard is natural rosewood, and the arched resonators are anodized gold that will not chip or peel. Ends are covered with handsome black vinyl.

Cross rails and resonators are hinged for compact folding; keyboard can be removed and replaced in seconds. The CONCERT GRAND model packs into

5 cases; the CENTURY packs into 4 cases. Fleece lined vinyl cover and four pairs of suitable mallets included. Fibre cases available at extra cost.

**SPECIFICATIONS:
 CONCERT GRAND MARIMBA**

Keyboard: 4½ octaves, A² to C⁷
 Bars: 2½" x 1½" to 1½" x ¾"
 Height: 35"—Length: 81¾"—Width low end: 31"—
 high end: 15"—Weight: 150 lbs.

**No. M-250—CONCERT GRAND MARIMBA,
 Illustrated \$1145.00B**

SPECIFICATIONS: CENTURY MARIMBA

Keyboard: 4 octaves, C³ to C⁷
 Bars: 2½" x 1½" to 1½" x ¾"
 Height: 35"—Length: 75¾"—Width low end: 31"—
 high end: 15"—Weight 131 lbs.

**No. M-150—CENTURY MARIMBA
 \$1030.00B**



PREP MARIMBA

The PREP Marimba was designed for student use, yet it possesses unusually full, rich tone. Because of this, there are more PREPS in use today than all other student type marimbas combined.

Finely designed features include easily removed genuine aluminum resonators, strong tubular legs which snap on and off in a jiffy, complete portability and light in weight, wide tone bars, perfectly tuned to A-440. Finish: black frame, silver-satin resonators, natural rosewood bars. Vinyl cover, 2 pairs suitable mallets included. Fibre carrying case available at extra cost.

SPECIFICATIONS:

Keyboard: 2½ octaves, C⁴ to F⁶
 Bars: 1½" x ¾"
 Height: 33"—Length: 36"—Width low end: 25¼"—high end: 12¾"—Weight: 22 pounds

No. M-20—PREP MARIMBA \$200.00B



TRINETTE MARIMBA

Here is a 3 octave marimba designed especially for the beginning keyboard percussionist. The Honduras rosewood bars, finely tuned to A-440, are the same size and range as the Musser No. 45 Vibe, thus allowing the student to progress from skills learned on the marimba to the vibe with little difficulty.

Baked, black wrinkle finish legs; gunmetal lustre finish frame; silver-satin resonators. Light in weight, the TRIETTE packs into only 2 cases for easy portability. Fleece lined vinyl cover and two pairs of suitable mallets included; cases extra.

SPECIFICATIONS:

Keyboard: 3 octaves, F³ to F⁶
 Bars: 1½" x ¾"
 Height: 35"—Length: 45¼"—Width low end: 28"—high end: 13"—Weight: 42 lbs.

No. M-60—TRINETTE MARIMBA \$350.00B

BRENTWOOD MARIMBA

The BRENTWOOD answers the need for a medium priced 4-octave marimba with tone quality and beauty only Musser master craftsmen can produce. The scientifically graduated tone bars, expertly tuned to A-440, are evenly voiced throughout the entire range. The exceptionally large resonators are perfectly tuned to their corresponding bars giving rich deep tones usually found in larger, more expensive instruments. The hinged rails plus light-weight resonators make this an exceptionally portable 4-octave instrument.

Finished in black ends and rails, natural rosewood keyboard, rich silver-satin resonators and bright chrome trim. Packs into 3 cases. Fleece lined vinyl cover and four pairs of suitable mallets included; cases extra.

SPECIFICATIONS:

Keyboard: 4 octaves, C³ to C⁷
 Bars: 2" x 1½" to 1¾" x ¾"
 Height: 35"—Length: 68"—Width low end: 29½"—high end: 14"—Weight: 70 lbs.

No. M-30—BRENTWOOD MARIMBA \$800.00B

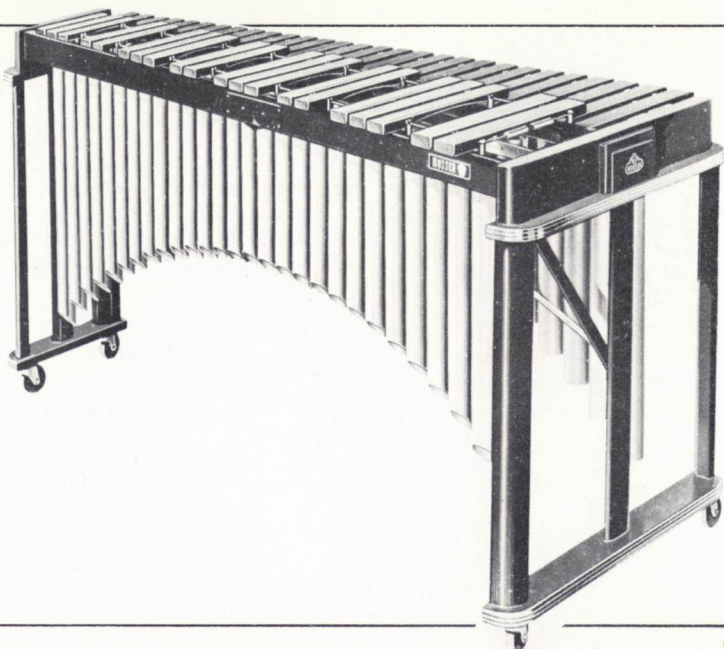

MUSSEER the quality standard
in mallet percussion: *XYLOPHONES*



PORTABLE XYLOPHONE

The Musser PORTABLE XYLOPHONE meets the highest standards set by today's top recording and symphonic artists. Tonal quality, resonance and tuning are beyond compare. Modern design and sturdy construction guarantee many years of rugged use and lasting beauty. A full 3½ octave keyboard of Honduras rosewood is expertly tuned to A-442 for that extra tonal edge preferred by most professional groups. Resonators detach from bottom and legs fold to a locking position for easy carrying. Fleece lined vinyl cover and three pairs of suitable mallets included; cases extra.

Here is the ideal Xylophone for every professional or school percussion section. An instrument of the finest quality designed to meet the growing demands in mallet percussion.

SPECIFICATIONS:

Keyboard: 3½ octaves, F⁴ to C⁸
Bars: 1½" wide and 7/8" thick
Height: 33½"—Length: 54"
Width low end: 32"—high end: 13"
Weight: 58 lbs.

No. M-50—PORTABLE XYLOPHONE\$545.00B



ELITE XYLOPHONE

The ELITE XYLOPHONE is one of the finest keyboard instruments for grade and junior high school use. This instrument is ideal for the school desiring a professional quality instrument at an economical price. The ELITE has the same resonators and thickness of bars as most professional xylophones to produce tone quality comparable to that of instruments costing much more. The bars of the keyboard are of Honduras rosewood and are precisely tuned to A-442. Aluminum resonators are finished in silver-satin lacquer; square aluminum legs have baked-on black lacquer finish. Fleece lined vinyl cover and two pairs of suitable mallets included; case extra.

SPECIFICATIONS:

Keyboard: 3 octaves, C⁵ to C⁸

Bars: 1½" wide and 7/8" thick

Height: 34"—Length: 44¾"

Width low end: 28½"—high end: 12¼"

Weight: 42 lbs.

No. M-43 ELITE XYLOPHONE \$375.00B

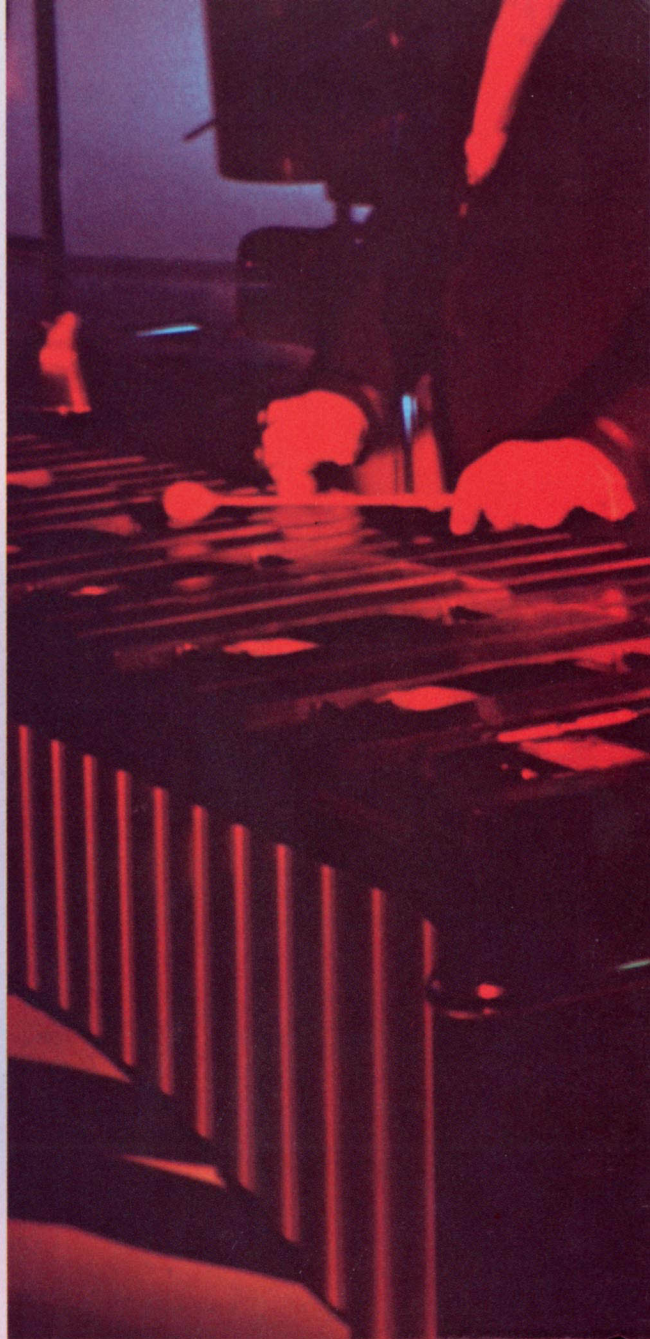

PICCOLO XYLOPHONE

The lightweight, portable PICCOLO XYLOPHONE is ideally suited for the professional "show drummer" and for use in the school music department. The bars of the keyboard are of Honduras rosewood, are finely tuned to A-442 and finished to provide an instrument of lasting satisfaction. Keyboard is built into sturdy carrying case with removable top. Two pairs of suitable mallets included.

SPECIFICATIONS:

Keyboard: 2½ octaves, G⁵ to C⁸

Bars: 1¾" wide and 5/8" thick

Case size: 34" x 21"

Weight with case: 24 lbs.

**No. M-40—
PICCOLO XYLOPHONE \$165.00B**

LUDWIG ... blend of tone, strength & playing ease!

perfection in modern bell lyras



No. M-2044

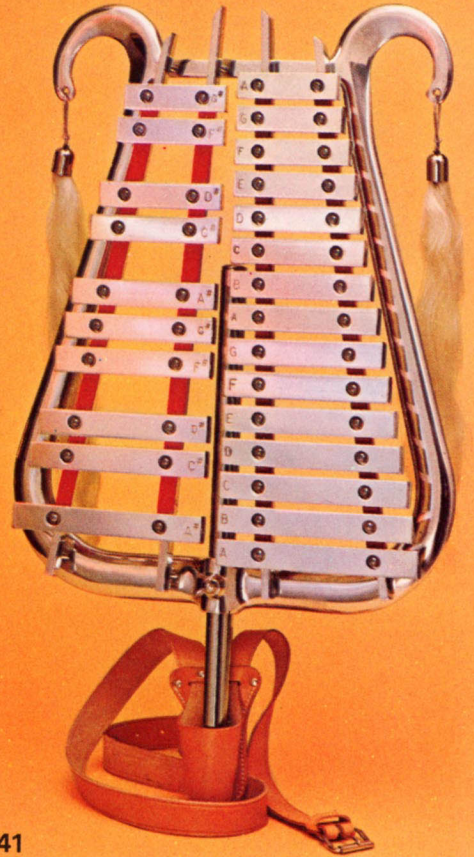

No. M-2041

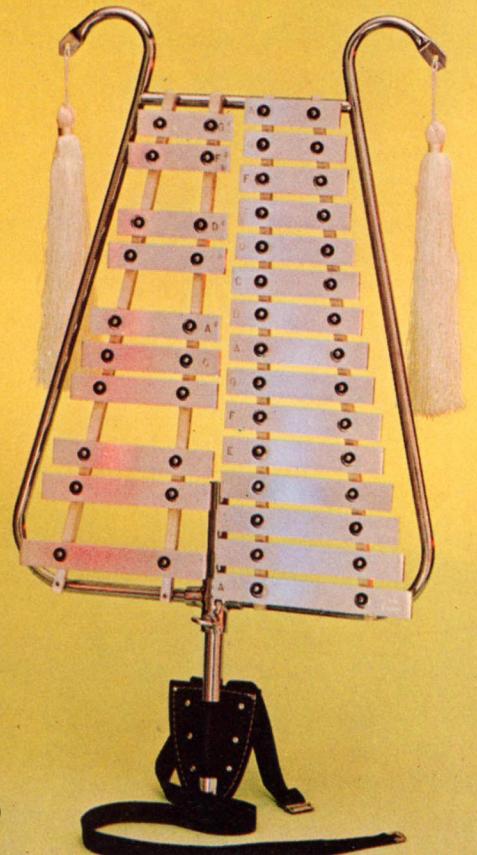

No. M-2040

THE CLASSIC BELL LYRA /deluxe model

Ludwig's advance design and quality craftsmanship has set new standards of perfection in modern bell lyras. Here is a blend of tone, beauty, strength and ease of playing, to provide the finest bell lyra on the market. Ludwig bell lyras are made in our own plant and tuned to A-440 by our own expert tuners. The deluxe model is ideal for use on the march as well as in the concert hall. Accidentals are finished in rich anodized gold; naturals are bright polished aluminum.

SPECIFICATIONS:

2 octaves, 25 bars A⁵ to A⁷
Aluminum bars: 1 1/4" wide, 3/8" thick. Raised accidentals; one piece aluminum frame; "Two-Tone" keyboard; felt covered mounting rails; Total weight: 13 lbs.

No. M-2044—DELUXE BELL LYRA complete with mallets, plumes, carrying strap and mackintosh zipper cover. **\$165.00**

THE MARCHING BELL LYRA / standard model

The Standard Model marching bell lyra is a quality instrument built to the high standards of the Ludwig tradition. The full two octave chromatic keyboard is expertly tuned to A-440. The aluminum bars and frame are highly polished to a gleaming luster. Durability, lightweight and ease of playing make the Standard Model tops in its field.

SPECIFICATIONS:

2 octaves, 25 bars A⁵ to A⁷
Aluminum bars: 1" wide, 3/8" thick; one piece aluminum frame; felt covered mounting rails; Total weight: 11 lbs.

No. M-2041—STANDARD BELL LYRA complete with mallets, plumes, carrying strap and mackintosh zipper cover. **\$130.00**

THE STADIUM BELL LYRA /lightweight

In presenting the bell lyra Model No. 2040, Ludwig offers the best quality, and most lightweight, economy-priced bell lyra on the market! Ideal for grade school or Junior High school marching bands, where weight and price are major factors, the bell lyra is constructed of satin-finish aluminum bars tuned to A-440, mounted on a triple chrome plated tubular frame and decorated with elegant white nylon plumes. Sling, mallets, carrying cover and adjustable carrying tube included. Here is the perfect bell lyra for your young school market!

SPECIFICATIONS:

Full-range, 2-octaves, 25 bar A⁵ to A⁷
Aluminum bars: 1" x 1/4";
one piece tubular frame
felt covered mounting rails;
weight: 6 3/4 lbs.

No. M-2040—BELL LYRA complete **\$105.00**

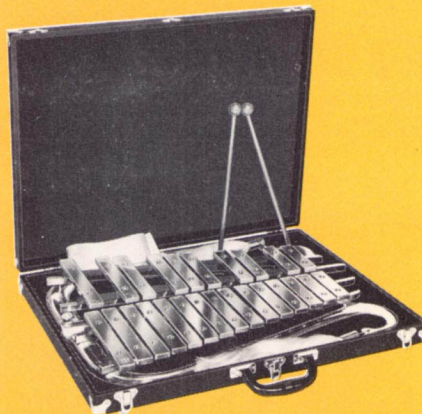

HARD SHELL BELL LYRA CASE

Here's added protection plus an ideal arrangement for using marching bell lyra in concert as orchestra bells. Case features durable leatherette covering, felt lining and quality hardware. Designed for either deluxe or Standard models.

No. M-8000—HARD SHELL BELL LYRA CASE. **\$27.00**

CONCERT BELL LYRA STAND

A quality concert bell lyra stand made from heavy-gauge stock. Stand is fully adjustable to any position and folds for easy transporting. Triple chrome plating adds to the beauty and long life.

No. M-2049—CONCERT BELL LYRA STAND. **\$22.00**

No. M-2046—BELL LYRA MUSIC HOLDER, chrome plated. **\$3.00**

LUDWIG OFFERS OUTSTANDING QUALITY

Ludwig bell lyras are supplied complete with 2 bell lyra mallets, 2 plumes, leather carrying strap and a zipper Mackintosh cover at no additional cost. These items may be purchased separately if desired.

No. M-640—Hard nylon Bell Lyra mallets, per pair. **\$ 3.30**

No. M-2047—Leather carrying strap, TAN. **9.50**

No. M-2047W—Leather carrying strap, WHITE. **10.50**

No. M-639—Hair plumes 16" long, white only, per pair. **4.50**

No. M-2048—Zipper Mackintosh cover for #2044 model. **11.50**

No. M-2048A—Zipper Mackintosh cover for #2041 model. **11.50**

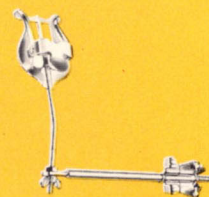

Musser

**THE QUALITY STANDARD IN
MALLET PERCUSSION**



CLASSIC CHIMES

The most modern concept in any chime design today . . . the CLASSIC CHIMES with added F# and G extends range upwards to allow performance in additional keys without transposing down for these notes. Tubes are of the finest brass available, carefully cut and precision tuned to A-442. Special tube caps provide greater tonal resonance and carrying power. New cable tube suspension will not break. An entirely advanced damper mechanism assures instant, trouble free control. Frame is finished in bright gold metallic lacquer; tubes are polished brass. Supplied with one rawhide mallet. Fleece lined vinyl cover and/or cases, extra.

Specifications:

Range: 1½ octaves, C⁵ to G⁶

Tubes: 1¼" outside diameter

Tube length: Low end 58"—high end 32¼"

Height: 64"—Width: 32"

Weight: 185 lbs.

No. M635 Classic Chimes \$920.00B

No. M636 Chime Cover \$25.00

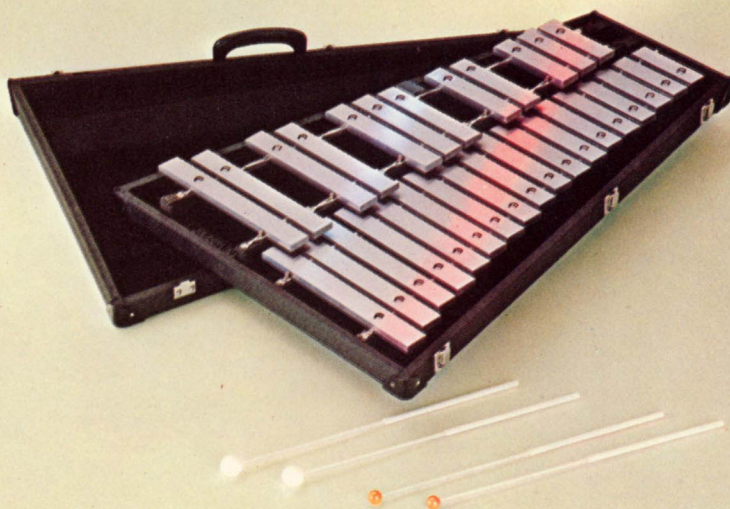

CLASSIC ORCHESTRA BELLS

The Musser CLASSIC ORCHESTRA BELLS are without comparison in brilliance, resonance and response. Made of the finest high-carbon tempered steel available, the bars are expertly tuned to A-442. Bars are satin finished and triple chrome plated. Musser's exclusive mounting process allows each note to ring free with greater tonal resonance. The keyboard is mounted in a sturdy, shaped case with detachable lid. Two sets of mallets are supplied with each instrument.

Specifications:

Keyboard: 2½ octaves, G⁵ to C⁸

Bars: 1¼" wide x ¾" thick

Case size: Length: 29"—Width low end 20"
—high end 10"

Weight, complete: 42 lbs.

No. M645 Classic Orchestra Bells \$225.00B

Introducing the NEW **MUSSEY**

AMPLI-CELESTE

The new Mussey AMPLI-CELESTE offers a fully extended 5-octave (C³ to C⁸) keyboard, with the finest piano action mechanism, providing the exact feel and action of an exceptional quality spinet piano . . . no lag or action delay. The tone, resonance and sustaining power surpass that of any standard celeste ever offered. Special front panel controls let you change the timbre to sound like muted bells, vibraphone or marimba by varying the intensity of vibrato, treble and bass. Removable music rack is of clear plexiglass. Silent on-off toggle switch; on-off indicator light; two external jacks in front of cabinet; one for practice with earphones only, the other for simultaneous earphone and external sound output. A third external jack in rear of cabinet allows connection of an additional amplifier system. Cabinet of laminated teakwood with satin ebony and brushed aluminum trim. Recessed handles on each side of cabinet for portability. Full dynamic range amplifier and matching 12" speaker.



SPECIFICATIONS:

Keyboard: 5 Octaves—C³ to C⁸
 Height: 31 3/4"
 Width: 21 1/2"
 Length: 38"
 Weight: 140 lbs. (Keyboard 40 lbs.—
 Cabinet 100 lbs.)
 Electric Input: 117V—60 Cycles
 Audio Output: 20 Watts

No. M77 Mussey Ampli-Celeste . . . **\$1095.00B**

DOLLY FOR CELESTE

Specially designed dolly (order separately) conveniently mobilizes celeste with ease; celeste can be played while on dolly.

No. M76 Dolly for Celeste **\$85.00B**

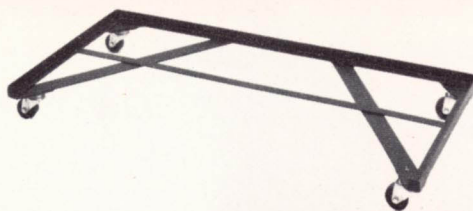

Easily removable keyboard and hinged top provides convenient maintenance of instrument.

Complete portability with sturdy recessed handles.

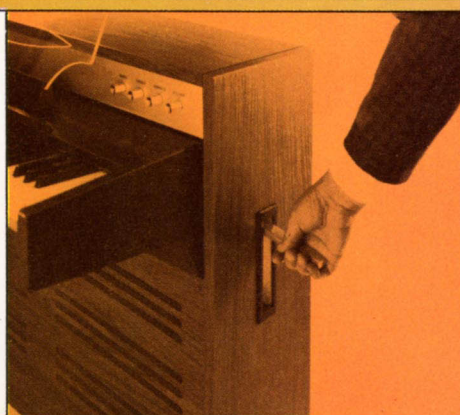

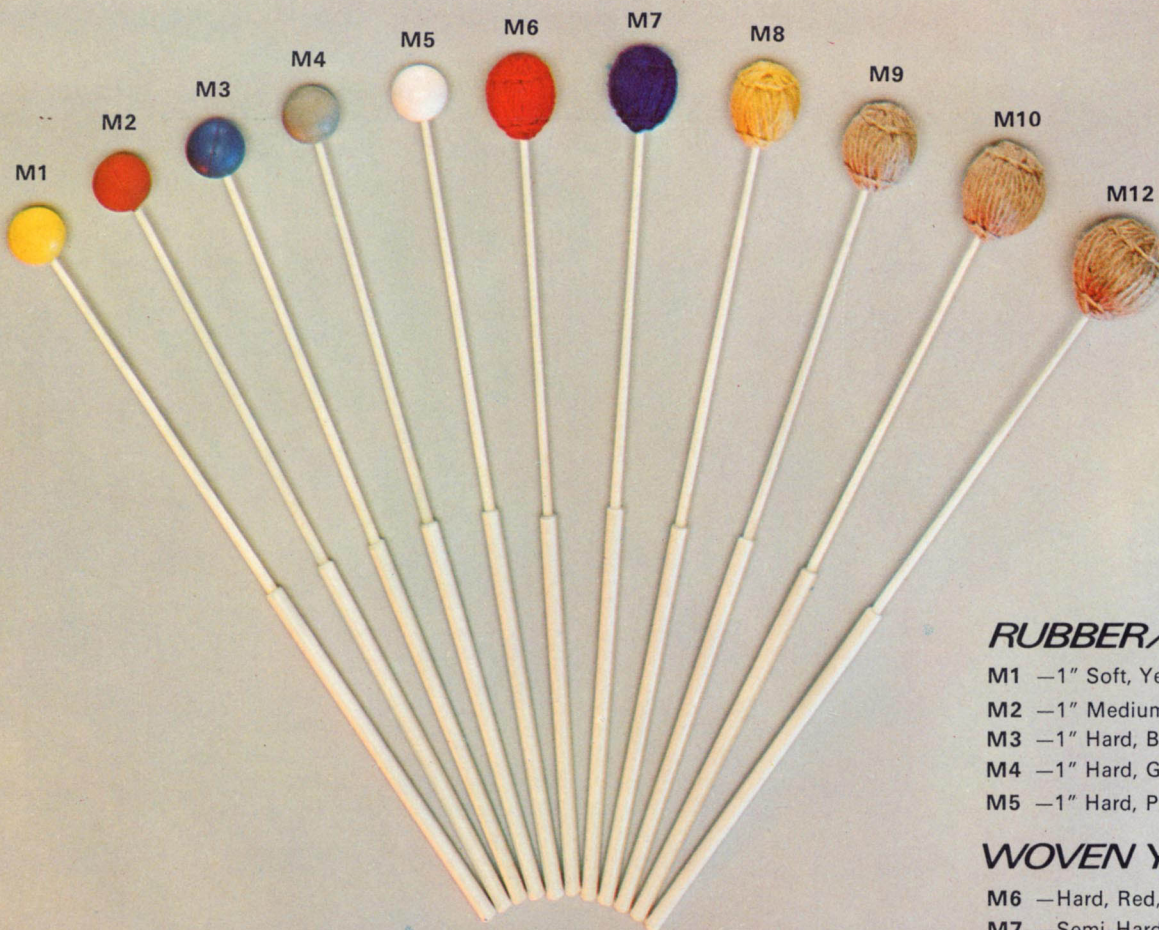

FIBERGLASS HANDLE MALLETS

New in concept! Polyethylene fiberglass handles feature perfect flexibility along with long lasting durability. Guaranteed non-warping; evenly matched for perfect balance. All mallet heads are of special formula rubber with a high gum content; only the finest grade yarn used on covered mallets. Each pair is carefully graded, matched and tested by experts, assuring complete satisfaction.

RUBBER/PLASTIC

- M1 —1" Soft, Yellow, per pair . . . \$3.85
- M2 —1" Medium, Red, per pair . . . \$3.85
- M3 —1" Hard, Blue, per pair \$3.85
- M4 —1" Hard, Gray, per pair \$3.85
- M5 —1" Hard, Plastic, per pair \$4.20

WOVEN YARN

- M6 —Hard, Red, per pair \$5.75
- M7 —Semi-Hard, Blue, per pair . . . \$5.75
- M8 —Medium Soft, Yellow, per pair \$5.75
- M9 —Soft, Gray, per pair \$5.75
- M10—Soft, Gray, (larger), per pair . \$6.50
- M12—Low Register Mallets, Gray, per pair \$7.00

BRASS MALLETS

Musser's brass mallets are especially constructed to produce a strong, clear response from the Orchestra Bells. Brass balls are mounted on flexible, durable fiberglass handles for use with the Orchestra Bells.

- M14—BRASS BELL MALLETS, per pair \$4.00

WOOD MALLETS

New from Musser! Specially developed hard maple wood ball mallets with fiberglass handles are particularly valuable for new sounds on Orchestra Bells in orchestral work.

- M15—HARD MAPLE, per pair \$3.85

CORD WOUND FIBERGLASS MALLETS

These new Musser mallets are wound with the finest four strand rayon sheen cord by specially developed machines to hold close tolerances. The exceptional long-lasting quality and precision manufacturing make these mallets the best on the market for use on any keyboard instrument. Handles are fiberglass.

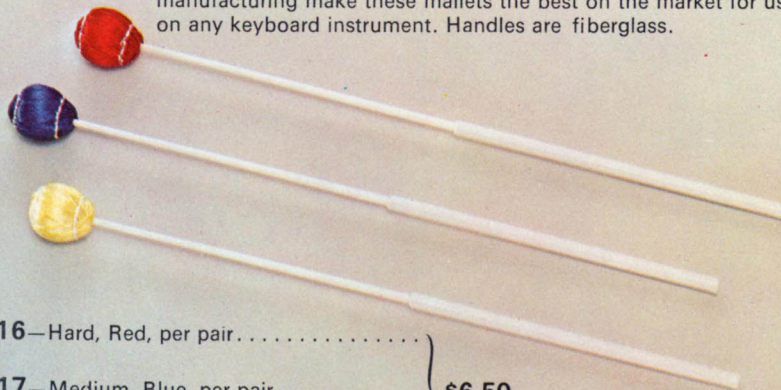

- M16—Hard, Red, per pair
- M17—Medium, Blue, per pair } \$6.50
- M18—Soft, Yellow, per pair

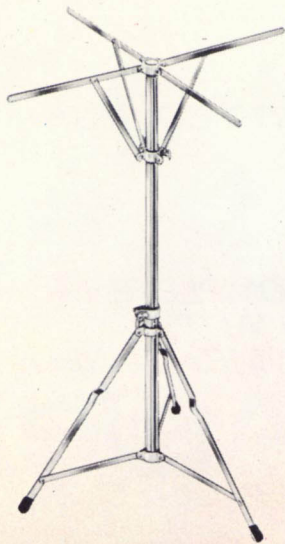

ORCHESTRA BELL STAND

A sturdy, heavy duty, folding stand designed to hold Orchestra Bells in playing position. Also ideal for holding the Piccolo Xylophone. Complete height adjustment accommodates seated or standing positions. Finished in beautiful triple chrome plate for years of service.

No. M1368—ORCHESTRA BELL STAND... \$30.00

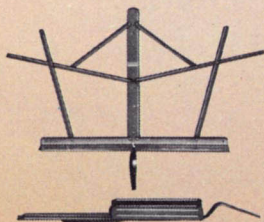

MUSIC RACK

For added convenience in practice and performance add a sturdy Musser music rack to your instrument. Durable in construction and lasting in design the rack mounts right onto most standard Musser instruments and folds when not in use. Available in your choice of brass or nickel plate finishes.

No. M117—MUSIC RACK, brass plate.. \$6.00

No. M118—MUSIC RACK, nickel plate.. \$6.00

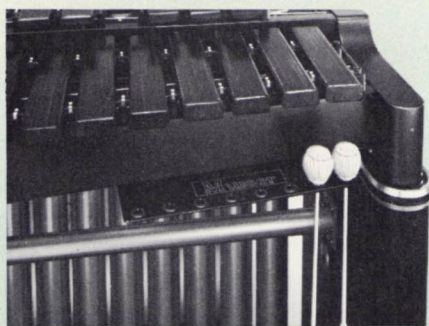

NEW MUSSER MALLET HOLDER

Sturdy, heavy-duty metal plate with rubber grommets attaches easily to underside of keyboard rail for convenient accessibility of mallets. Holder also prevents loss of mallets in performance and can be slipped off of instrument when not in use. Holds four pairs of mallets.

M812—MALLET HOLDER..... \$5.75

NEW TUNING FORKS

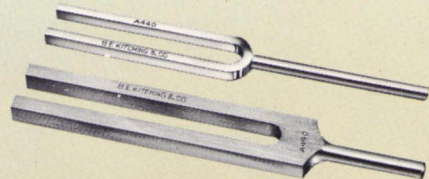

Here are two tuning forks made of tempered metal to meet the demands for high grade, scientific tuning forks for the music industry.

CHROME-PLATED, STEEL TUNING FORKS, tines: 3/16" x 1/4", overall height: 6 1/2".

No. 516—A=440 VPS TUNING FORK.....
 No. 517—Bb=466.2 VPS TUNING FORK..... } \$2.55
 No. 518—C=523.3 VPS TUNING FORK.....

SATIN-FINISH ALUMINUM TUNING FORK, tines: 5/16" x 3/8", overall height: 7".

No. 519—A=440 VPS TUNING FORK.....
 No. 520—Bb=466.2 VPS TUNING FORK..... } \$5.55
 No. 521—C=523.3 VPS TUNING FORK.....

This tuning bar features a spring-mounted rubber bumper which strikes the bar to produce a true tone, thus eliminating the need for a separate mallet. The accurately tuned, 1/4" thick x 1 1/4" wide, brushed aluminum alloy bar is mounted on a precision built, black lacquered birch resonator box.

No. 522—A=440 VPS TUNING BAR..... } \$20.00
 No. 523—Bb=466.2 VPS TUNING BAR.....

NEW, SELF-CONTAINED TUNING BAR

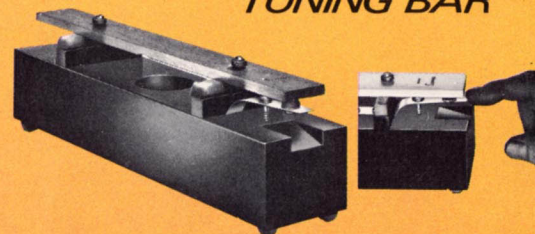

SOUNDED SCALE RANGES...MUSSER MALLET PERCUSSION INSTRUMENTS

STANDARD TUNING OF MUSSER INSTRUMENTS

Marimbas, Vibes and Bell Lyras are tuned to A=440; Xylophones, Orchestra Bells and Chimes are tuned to A=442. If special tuning other than above is desired, specify with order.

Marimbas:

Model No. M250 A2-C7
 Model No. M150 C3-C7
 Model No. M30 C3-C7
 Model No. M60 F3-F6
 Model No. M20 C4-F6

Vibes:

Model No. M75 F3-F6
 Model No. M55 F3-F6
 Model No. M45 F3-F6

Xylophones:

Model No. M50 F4-C8
 Model No. M43 C5-C8
 Model No. M40 G5-C8
 Model No. M635 C5-C6

Chimes:

Orchestra Bells:

Model No. M645 G5-C8

Bell Lyra:

Model No. M2044 A5-A7
 Model No. M2041 A5-A7

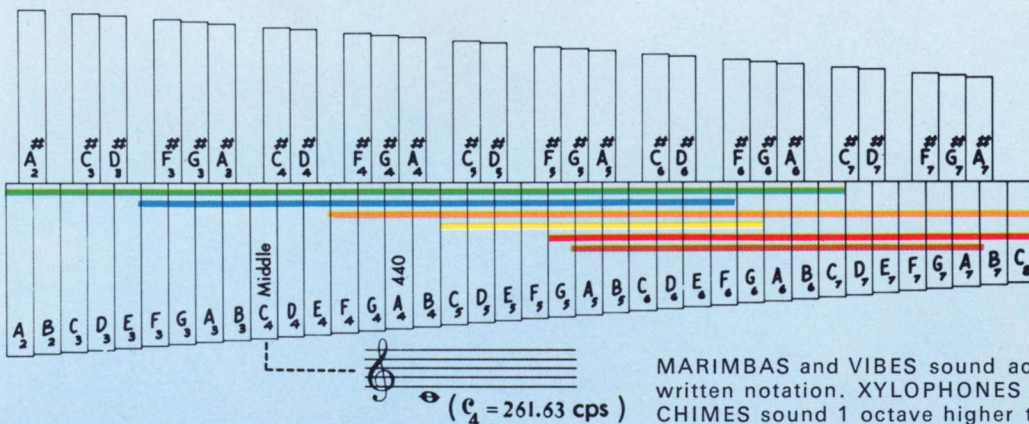

MARIMBAS and VIBES sound actual written notation. XYLOPHONES and CHIMES sound 1 octave higher than written notation. ORCHESTRA BELLS and BELL LYRAS sound 2 octaves higher than written notation.



No. M336—RAWHIDE CHIME MALLET, each..... \$6.50

PAiSte *cymbals... a rainbow of sound colors!*

Today, the "art" of cymbal making and the bold new concepts in their musical application have been advanced greatly by the combined efforts of the M. M. PAISTE COMPANY and LUDWIG DRUM COMPANY. Together they have established new highs in consistent cymbal quality and most important, new standards in cymbal "SOUNDS"

3 COMPLETE
QUALITY
CYMBAL LINES

PAiSte
FORMULA 602

PAISTE Formula 602 cymbals offer the ultimate in cymbal quality, as well as a new, brilliant sound dimension. These cymbals enjoy professional acceptance and demand because they fulfill the exacting needs of professional percussionists. PAISTE Formula 602 cymbals are unsurpassed in today's cymbal market!



Moderately priced . . . quality produced! The LUDWIG STANDARD cymbal line offers the high-quality, professional features of excellent tone, resonance and response to provide the best quality cymbals possible in their medium price range. This is an excellent "all round" line that has already proven its performance success.

STANOPLÉ
PAISTE

Ludwig STANOPLÉ, an economy priced line of quality cymbals! Their fine tone, response and timbre surpass all others in their price range and will fulfill your need where budgetary problems are concerned. Ideal for students and beginners!

paiste formula 602 cymbals

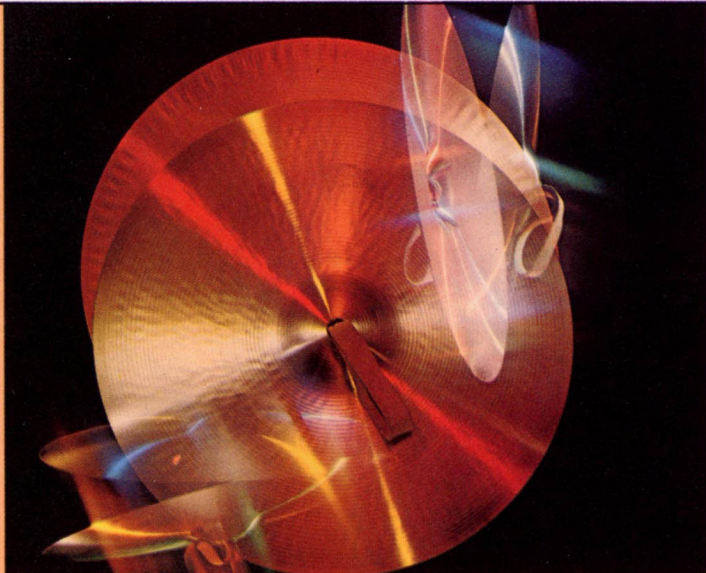

NEW CONCEPTS IN PAISTE CONCERT CYMBALS

The new PAISTE FORMULA 602 Concert Cymbals are the result of several years of experimenting and testing by both Paiste and Ludwig cymbal experts. Now, an entirely new concept in concert cymbal response, sound color and over-all tonal effect has been developed to meet the exacting demands of today's modern music. Each cymbal is custom crafted for particular sound characteristic and carefully matched by cymbal experts. Now every director can be assured of getting the type of cymbals which best meet his requirements. Available in sizes and sound characteristic as listed below.

Type "A"—Medium weight cymbals with a full-range, mellow tone; medium response with a "zing" attack.

| | |
|------------------------------------|----------|
| No. 717-CA—17", per pair | \$120.00 |
| No. 702-CA—18", per pair | 129.25 |
| No. 703-CA—19", per pair | 145.25 |
| No. 704-CA—20", per pair | 157.75 |
| No. 721-CA—21", per pair | 178.50 |

Type "B"—Medium-heavy weight cymbals with a heavy, bright tone; pronounced, but slower, response with a "crash" attack.

| | |
|------------------------------------|----------|
| No. 702-CB—18", per pair | \$129.25 |
| No. 703-CB—19", per pair | 145.25 |
| No. 704-CB—20", per pair | 157.75 |

Type "C"—Medium-thin weight cymbals with a deep, dark tone; vibrant, fast response with a "Splash" attack.

| | |
|------------------------------------|----------|
| No. 702-CC—18", per pair | \$129.25 |
| No. 703-CC—19", per pair | 145.25 |
| No. 704-CC—20", per pair | 157.75 |

"SOUND COLOR" SET

A complete packaged set of four concert cymbals offering a wide range of tonal colors. When combined with each other, cymbals I, II and III offer similar sounds which are much of the same color possibilities as A, B, and C of the new concert cymbal line. The fourth, SPECIAL EFFECTS, cymbal is distinguishable by a special rubber grommet mounted approximately 2½" from the edge. This grommet acts as a mute for the cymbal; ideal for sforzando-piano or forte-piano effects and for playing complex rhythmic figures.

| | |
|------------------------------------------------------------------------------------------|----------|
| No. 705-CS—19" SET OF 4 FORMULA 602, SOUND COLOR, CONCERT CYMBALS, per set | \$284.00 |
| No. 706-CS—19" FORMULA 602, SPECIAL EFFECTS, CONCERT CYMBAL WITH GROMMET, each | 72.65 |

PAISTE Formula 602 Cymbals are created with exacting care by expert craftsmen, in combination with the finest materials and electronic testing equipment.

In addition to the special metal content, each Formula 602 cymbal is manufactured according to prescribed size, weight, measurement, and shape.

SUSPENDED CYMBALS

Please specify weight using the following suffixes after the number designation: T-Thin, M-Medium, H-Heavy.

| | |
|------------------------------|----------|
| No. 710—10", each | \$ 29.50 |
| No. 711—11", each | 31.25 |
| No. 712—12", each | 34.25 |
| No. 713—13", each | 39.00 |
| No. 714—14", each* | 42.00 |
| No. 715—15", each* | 46.75 |
| No. 716—16", each* | 53.25 |
| No. 717—17", each* | 60.00 |
| No. 718—18", each* | 64.25 |
| No. 719—19", each* | 72.65 |
| No. 720—20", each* | 79.00 |
| No. 721—21", each* | 89.25 |
| No. 722—22", each | 101.25 |
| No. 723—23", each | 112.45 |
| No. 724—24", each | 130.00 |

*Not available in heavy weight.

MARCHING CYMBALS

Special Marching cymbals are carefully matched and packaged in pairs.

| | |
|------------------------------------|----------|
| No. 707-MA—14", per pair | \$ 84.00 |
| No. 708-MA—15", per pair | 93.50 |
| No. 709-MA—16", per pair | 106.50 |
| No. 783-MA—17", per pair | 120.00 |
| No. 784-MA—19", per pair | 145.30 |
| No. 785-MA—21", per pair | 178.50 |
| No. 786-MA—23", per pair | 224.90 |

OUTFIT CYMBALS

There is a distinct difference in weight, measurement, and shape of a crash cymbal as opposed to a ride cymbal in the same size. The thin crash cymbal is designed to respond instantly with a full bodied tone, whereas the medium ride cymbal is designed to produce a high ping, rhythmic effect without a great deal of undertone rumble building up to obscure the basic rhythmic pattern.

Each pair of Hi-Hat cymbals is carefully matched to give a good chick-sound when played with the foot, and a full bodied, bright sound when played with the sticks.

CRASH AND RIDE CYMBALS

Please specify response using the following suffixes after the number designation: TC-Thin Crash, MR-Medium Ride.

| | |
|-----------------------------|---------|
| No. 717—17", each | \$60.00 |
| No. 718—18", each | 64.25 |
| No. 719—19", each | 72.65 |
| No. 720—20", each | 79.00 |

Rivets can be added to any size and weight cymbal at an extra charge of \$2.00 per cymbal. Non-returnable after rivets have been installed.

HI-HAT CYMBALS

| | |
|------------------------------------|----------|
| No. 726-HH—12", per pair | \$ 68.50 |
| No. 727-HH—13", per pair | 78.00 |
| No. 728-HH—14", per pair | 84.00 |
| No. 729-HH—15", per pair | 93.50 |
| No. 730-HH—16", per pair | 106.50 |

LUDWIG cymbals

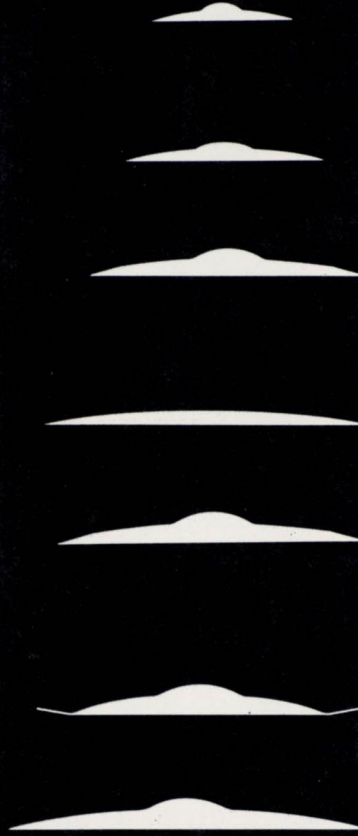
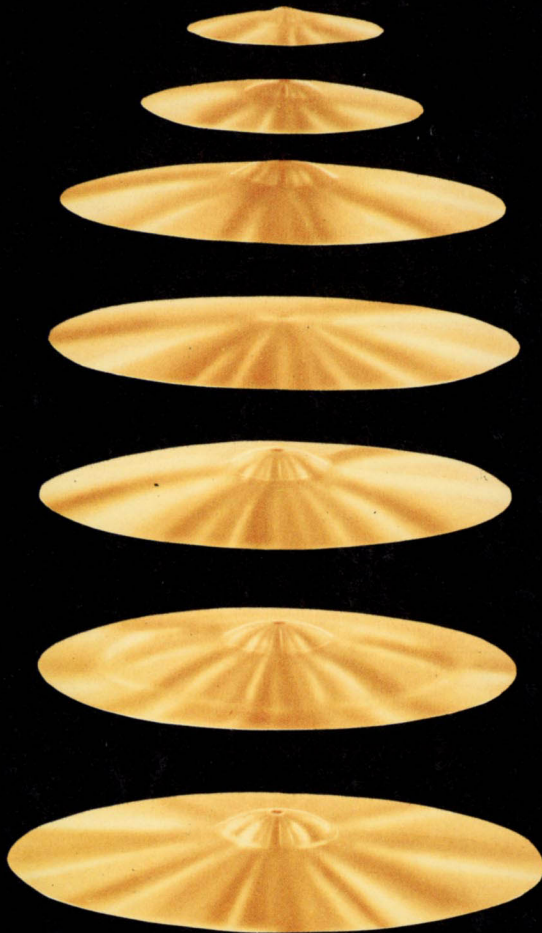

NEW 7 "SPECIAL SOUND" CYMBALS

A totally new concept in tone colors! A set of seven Paiste Formula 602 Cymbals . . . each with its own distinct sound characteristic. Combined, they produce a rainbow of exciting sounds . . . used individually is another adventure in itself.

- No. 735-1-8" BELL CYMBAL** \$ 36.25
A very high sound comparable to a triangle, but sharper, with more carry-thru.
- No. 735-2-11" "SPLASH" CYMBAL** 42.75
Used for brief "splash" effects, closely related to the 2-beat "early jazz" sound.
- No. 735-3-17" "BRIGHT RIDE" CYMBAL** 73.25
Produces an intense "pingy" sound, virtually without vibration.
- No. 735-4-18" "FLAT RIDE" CYMBAL** 83.50
Can be played vigorously or gently without building, yet carries amazingly far.
- No. 735-5-18" "RIDE/CRASH" CYMBAL** 83.50
A very distinct low ride sound. Can produce explosive or short, fuller crash.
- No. 735-6-18" "CHINA TYPE" CYMBAL** 83.50
Similar to Chinese sound, but with greater brilliance and definition.
- No. 735-7-20" "DEEP RIDE" CYMBAL** 106.00
Delivers a beautifully deep-sounding ride, and a round, short crash.
- No. 736-SET OF 7 SPECIAL SOUND CYMBALS** (Nos. 735-1, 2, 3, 4, 5, 6, 7) \$497.00
- No. 737-20" "FLAT RIDE" CYMBAL** 106.00
- No. 738-20" "CHINA TYPE" CYMBAL** 106.00

NEW "GIANT BEAT" CYMBALS

The new "Giant Beat" cymbals, specially engineered and crafted to cut through the heavy amplification of the other instruments in today's Rock groups, have a dynamic carrying power with clear definition; they offer a new dimension in tonal balance for Rock groups of any size. May be purchased in sets or individually.

- No. 731-15" HI-HAT CYMBALS**, per pair \$ 85.75
- No. 732-18" CRASH**, each 61.25
- No. 733-20" RIDE**, each 75.25
- No. 739-24" RIDE**, each 112.00
- No. 734-SET OF 4 GIANT BEAT CYMBALS** (Nos. 731, 732, 733) 215.00

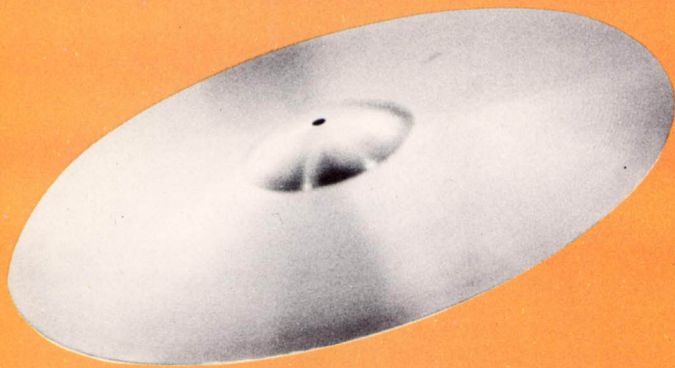

LUDWIG STANDARD CYMBALS

Made in Europe by PAISTE, the LUDWIG STANDARD Cymbal line offers the high-quality, professional features of excellent tone, resonance and response. These cymbals are carefully crafted by cymbal manufacturing experts to provide the best quality cymbals possible in their medium price range. They are available in a variety of sizes and weights to meet the requirements of almost any need.

All LUDWIG STANDARD Cymbals are offered in Thin, Medium and Heavy weights. Hi-Hat and concert hand cymbals are carefully matched at the factory and specially packaged in pairs.

SUSPENDED OR HAND CYMBALS

Please specify weight using the following suffixes after the number designation: T-Thin, M-Medium, H-Heavy. When ordering concert hand cymbals, specify (2) of the catalog number and state category in addition to weight desired.

| | |
|-----------------------------|---------|
| No. 210—10", each | \$12.00 |
| No. 211—11", each | 14.50 |
| No. 212—12", each | 17.75 |
| No. 213—13", each | 21.25 |
| No. 214—14", each | 24.50 |
| No. 215—15", each | 28.25 |
| No. 216—16", each | 31.50 |
| No. 217—17", each | 34.25 |
| No. 218—18", each | 37.25 |
| No. 219—19", each | 41.50 |
| No. 220—20", each | 45.00 |
| No. 221—21", each | 49.50 |
| No. 222—22", each | 53.75 |

Rivets can be added to any size and weight cymbal above at an extra charge of \$2.00 per cymbal. Non-returnable after rivets have been installed.

MARCHING CYMBALS

| | |
|------------------------------------|----------|
| No. 213-MA—13", per pair | \$ 42.50 |
| No. 214-MA—14", per pair | 49.00 |
| No. 215-MA—15", per pair | 56.50 |
| No. 216-MA—16", per pair | 63.00 |
| No. 217-MA—17", per pair | 68.50 |
| No. 218-MA—18", per pair | 74.50 |
| No. 219-MA—19", per pair | 83.00 |
| No. 220-MA—20", per pair | 90.00 |
| No. 221-MA—21", per pair | 99.00 |
| No. 222-MA—22", per pair | 107.50 |

HI-HAT CYMBALS

| | |
|------------------------------------|---------|
| No. 213-HH—13", per pair | \$42.50 |
| No. 214-HH—14", per pair | 49.00 |
| No. 215-HH—15", per pair | 56.50 |
| No. 216-HH—16", per pair | 63.00 |

LUDWIG STANOPOLE ...A QUALITY LINE OF ECONOMY-PRICED CYMBALS

Made by PAISTE, to offer excellent cymbals without a big investment, these imported cymbals are approved and endorsed by Ludwig Drum Company for their fine tone, response and timbre. LUDWIG STANOPOLE Cymbals are ideal for the beginner or student, and are particularly useful in the grade school, band/orchestra or in a small combo. Here is a line of cymbals that out-perform any others in their price range.

| | |
|-----------------------------------------|---------|
| No. 230—11" MEDIUM-THIN, each | \$ 9.50 |
| No. 231—12" MEDIUM-THIN, each | 11.25 |
| No. 232—13" MEDIUM-THIN, each | 13.25 |
| No. 233—14" MEDIUM-THIN, each | 15.50 |
| No. 234—15" MEDIUM-THIN, each | 18.00 |
| No. 235—16" MEDIUM-THIN, each | 22.00 |
| No. 236—18" MEDIUM-THIN, each | 27.25 |
| No. 237—20" MEDIUM-THIN, each | 35.75 |

Above STANOPOLE Cymbal sizes are supplied in one universal MEDIUM-THIN weight only for concert and outfits (ride, crash and hi-hat purposes). Concert and hi-hat cymbals are matched in pairs. (When ordering, specify 2 of the catalog number and state category.)

| | |
|------------------------------------------|---------|
| No. 238—14" MEDIUM-HEAVY, per pair . . . | \$30.25 |
| No. 239—15" MEDIUM-HEAVY, per pair . . . | 35.25 |
| No. 240—16" MEDIUM-HEAVY, per pair . . . | 43.50 |

The above STANOPOLE Marching cymbals are available in one universal MEDIUM-HEAVY weight only and are supplied in matching pairs.



sound edge

HI-HAT CYMBALS

Here is the very latest in cymbal developments . . . SOUND EDGE by PAISTE . . . a new concept in Hi-Hat Cymbals designed to prevent "air lock."

After years of development and market testing, the acceptance of the new PAISTE SOUND EDGE Hi-Hat Cymbals by leading drummers the world over is overwhelming! Although more expensive than the regular PAISTE Formula 602 Hi-Hats, the new SOUND EDGE has proven superior to all others on the market today. SOUND EDGE has full bodied tonal quality and response to match any style of music. Drummers prefer their clear high pitch "chick" sound when used with the pedal.

| | |
|----------------------------------------------------------------|----------|
| No. 725—14" SOUND EDGE HI-HAT CYMBALS, per pair | \$106.25 |
| No. 725-1—15" SOUND EDGE HI-HAT CYMBALS, per pair | 115.75 |

LUDWIG gongs

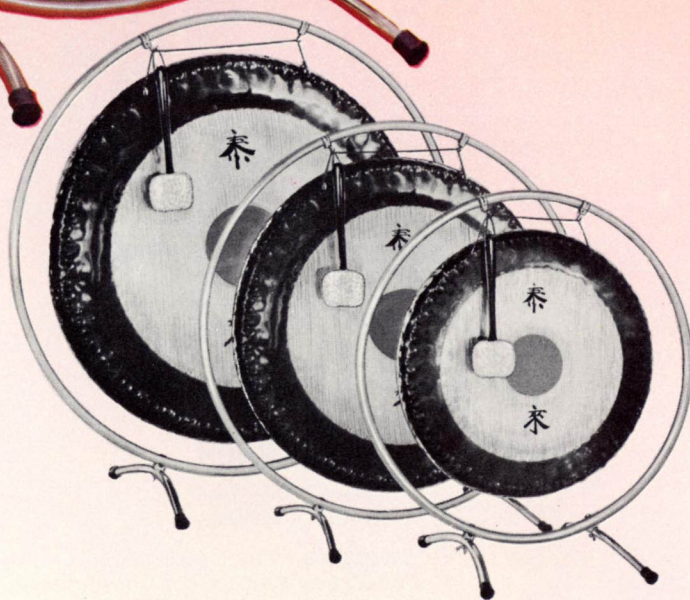
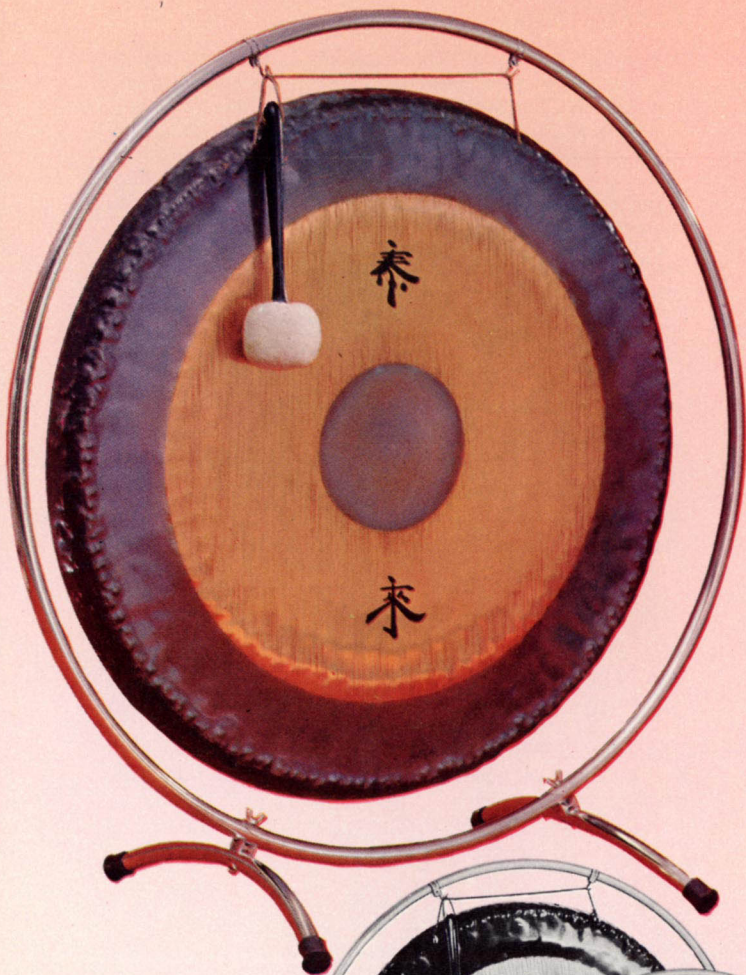

PAISTE SYMPHONIC GONGS

The PAISTE SYMPHONIC GONG has become the quality standard throughout the world. The overwhelming choice of noted conductors and performers, PAISTE gongs offer a variety of deep, rich resonant tone that you feel as well as hear. Each gong is tempered and hand hammered from special metals with delicate care and old-world craftsmanship. The musical quality of these gongs is beyond compare . . . no musical organization is quite complete without several of various sizes and tonal colors. One suitable mallet is supplied with each gong at no additional cost.

SYMPHONIC GONGS

| | |
|---------------------------|----------|
| No. 753—20" Diameter..... | \$ 62.50 |
| No. 768—22" Diameter..... | 114.50 |
| No. 754—24" Diameter..... | 142.50 |
| No. 755—26" Diameter..... | 178.00 |
| No. 756—28" Diameter..... | 228.50 |
| No. 757—30" Diameter..... | 294.50 |
| No. 758—32" Diameter..... | 376.50 |
| No. 769—34" Diameter..... | 527.00 |
| No. 767—36" Diameter..... | 650.50 |
| No. 759—38" Diameter..... | 794.00 |
| No. 760—50" Diameter..... | 4,436.50 |
| No. 761—60" Diameter..... | 7,125.50 |

GONG STANDS

Ludwig Symphonic Gong Stands are now available in three diameters to accommodate any size gong. Full steel circle assures rigid support for even the largest sizes. Modern curved feet are mounted on main circle with new, non-twist brackets for maximum stability. Non-slip rubber tips provide firm anchorage. Adjustable hooks allow centering of gong in stand for balanced weight distribution. Stand is triple chrome-plated for lasting beauty.

| | |
|-------------------------------------------------|---------|
| No. 764—Gong Stand for sizes 20" to 24"..... | \$35.00 |
| No. 762—Gong Stand for sizes 26" to 30"..... | 40.00 |
| No. 763—Gong Stand for sizes 32" to 40"..... | 45.00 |
| No. 765—Gong Stand for 50" size... | 135.00 |
| No. 766—Gong Stand for 60" size... | 175.00 |



DINNER GONGS

Exact miniature of the famous PAISTE symphonic gong makes an ideal gift or decoration for your home. Complete with mallet and stand.

| | |
|------------------------|---------|
| No. 750— 7" Diameter . | \$17.00 |
| No. 751—10" Diameter . | 26.00 |
| No. 752—16" Diameter . | 52.50 |



ANTIQUE FINGER CYMBALS

Provide a high pitched ring required in many contemporary compositions. Produce the proper dissonance for the most authentic "Oriental" sound. Packaged in pairs; bronze alloy antique finish.

| | |
|----------------------------------------------------|--------|
| No. 83—Paiste Antique Finger Cymbals, pair..... | \$6.50 |
|----------------------------------------------------|--------|

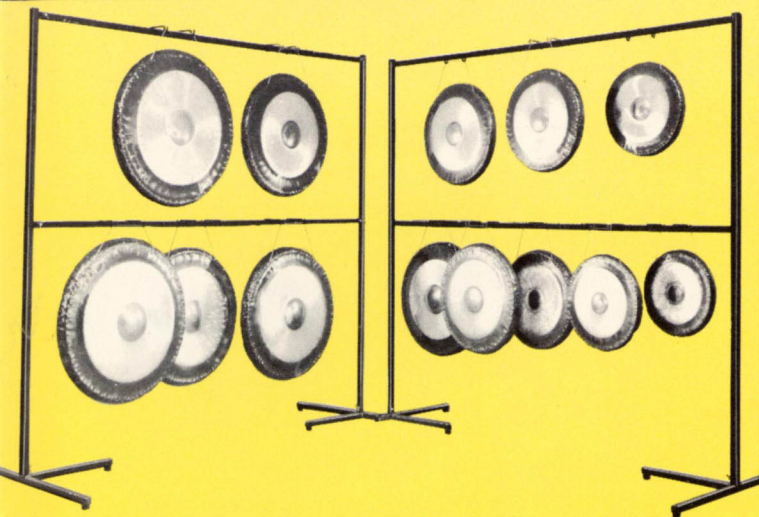

PAISTE CHROMATIC GONG PLAYS

PAISTE, world famous for quality Symphonic gongs, now offers a choice of 54 pitched gongs with raised center *BOSS*. Expertly tuned, these pitched gongs are available individually or in chromatic octave sets. Sizes range from 38" (C5) to 6" (F6). Chromatic gongs offer a multitude of new sound colors to the modern composer/arranger and can be scored as a melodic or harmonic voice.

Stands for each Chromatic Gong Play are available separately as listed on this page. No. 741, 742, 743, 744 Chromatic Gong Plays are priced complete with stands and mallets.

- No. 741—CHROMATIC GONG PLAY C5 to C6... \$ 686.00
- No. 742—CHROMATIC GONG PLAY C4 to C5... 940.00
- No. 743—CHROMATIC GONG PLAY C3 to C4... 1,852.00
- No. 744—CHROMATIC GONG PLAY C2 to C3... 6,929.00
- No. 748—Stand only for No. 741 Gong Play... 248.00
- No. 748—Stand only for No. 742 Gong Play... 248.00
- No. 746—Stand only for No. 743 Gong Play... 169.00
- No. 746—Stand only for No. 744 Gong Play... 169.00

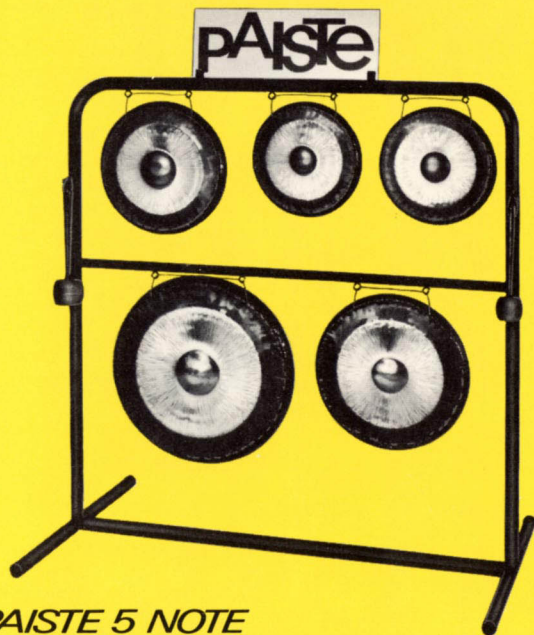

PAISTE 5 NOTE CONCERT GONG PLAY

The new PAISTE 5 NOTE CONCERT GONG PLAY has already proven popular in the concert, jazz, rock and pop fields as the composer/arranger turns to the multitude of sound color offered by pitched gongs. Each pitched gong has a raised center *BOSS* and produces a distinct sound color all its own. Pitches included are: Eb3, G3, Bb3, D4, Eb4. A heavy duty stand and two mallets are included.

- No. 740—5 NOTE CONCERT GONG PLAY, complete with stand and mallets... \$624.50

PAISTE PITCHED GONGS PRICE LIST

| NUMBER | SIZE | PITCH | PRICE |
|------------|------|-------|------------|
| No. 745-1 | 38" | C 2 | \$1,117.60 |
| No. 745-2 | 38" | C#2 | 1,117.60 |
| No. 745-3 | 36" | D | 901.60 |
| No. 745-4 | 34" | D#2 | 730.85 |
| No. 745-5 | 32" | E 2 | 523.50 |
| No. 745-6 | 30" | F 2 | 415.15 |
| No. 745-7 | 30" | F#2 | 415.15 |
| No. 745-8 | 28" | G 2 | 320.60 |
| No. 745-9 | 28" | G#2 | 320.60 |
| No. 745-10 | 26" | A 2 | 258.70 |
| No. 745-11 | 26" | A#2 | 258.70 |
| No. 745-12 | 24" | B 2 | 203.70 |
| No. 745-13 | 24" | C 3 | 203.70 |
| No. 745-14 | 22" | C#3 | 158.85 |
| No. 745-15 | 22" | D 3 | 158.85 |
| No. 745-16 | 20" | D#3 | 128.30 |
| No. 745-17 | 20" | E 3 | 128.30 |
| No. 745-18 | 18" | F 3 | 124.70 |
| No. 745-19 | 18" | F#3 | 124.70 |
| No. 745-20 | 16" | G 3 | 109.55 |
| No. 745-21 | 16" | G#3 | 109.55 |
| No. 745-22 | 14" | A 3 | 106.00 |
| No. 745-23 | 14" | A#3 | 106.00 |
| No. 745-24 | 13" | B 3 | 73.75 |
| No. 745-25 | 13" | C 4 | 73.75 |
| No. 745-26 | 12" | C#4 | 70.85 |
| No. 745-27 | 12" | D 4 | 70.85 |
| No. 745-28 | 12" | D#4 | 70.85 |
| No. 745-29 | 11" | E 4 | 68.80 |
| No. 745-30 | 11" | F 4 | 68.80 |
| No. 745-31 | 11" | F#4 | 68.80 |
| No. 745-32 | 10" | G 4 | 55.00 |
| No. 745-33 | 10" | G#4 | 55.00 |
| No. 745-34 | 10" | A 4 | 55.00 |
| No. 745-35 | 8½" | A#4 | 50.95 |
| No. 745-36 | 8½" | B 4 | 50.95 |
| No. 745-37 | 8½" | C 5 | 50.95 |
| No. 745-38 | 8½" | C#5 | 50.95 |
| No. 745-39 | 7" | D 5 | 35.85 |
| No. 745-40 | 7" | D#5 | 35.85 |
| No. 745-41 | 7" | E 5 | 35.85 |
| No. 745-42 | 6½" | F 5 | 34.25 |
| No. 745-43 | 6½" | F#5 | 34.25 |
| No. 745-44 | 6½" | G 5 | 34.25 |
| No. 745-45 | 6½" | G#5 | 34.25 |
| No. 745-46 | 6" | A 5 | 33.00 |
| No. 745-47 | 6" | A#5 | 33.00 |
| No. 745-48 | 6" | B 5 | 33.00 |
| No. 745-49 | 6" | C 6 | 33.00 |
| No. 745-50 | 6" | C#6 | 33.00 |
| No. 745-51 | 6" | D 6 | 33.00 |
| No. 745-52 | 6" | D#6 | 33.00 |
| No. 745-53 | 6" | E 6 | 33.00 |
| No. 745-54 | 6" | F 6 | 33.00 |

LUDWIG *cymbal and gong accessories*

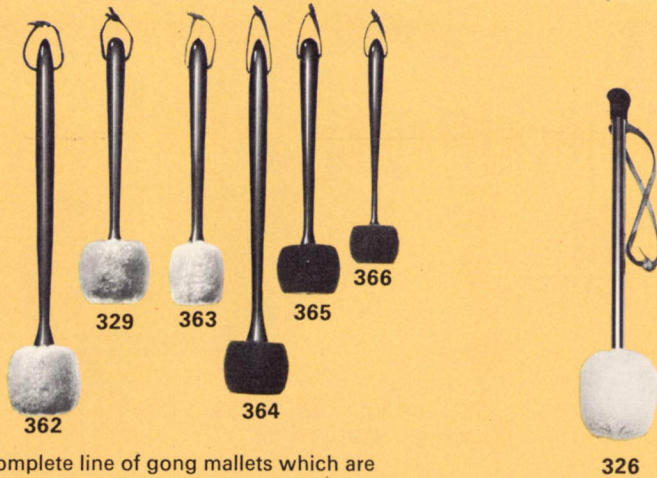

GONG MALLETS

Ludwig presents a complete line of gong mallets which are specifically designed to produce the ideal tone quality from any given gong size. Lamb's wool or top quality felt heads are mounted on strong wooden handles.

- No. 362—MALLET FOR 32" TO 38" GONG, Lamb's Wool \$12.50
- No. 329—MALLET FOR 26" TO 30" GONG, Lamb's Wool 9.00
- No. 363—MALLET FOR 24" GONG, Lamb's Wool 8.60
- No. 364—MALLET FOR 32" TO 38" GONG, Gray Felt 9.50
- No. 365—MALLET FOR 24" TO 30" GONG, Gray Felt 5.50
- No. 366—MALLET FOR 20" GONG, Gray Felt. 4.50

DELUXE GONG MALLET

Ludwig offers a deluxe, special gong mallet that is properly weighted to bring out the deep, rich tone of the gong. Supplied with Lamb's wool head on chrome-plated steel handle.

No. 326—DELUXE GONG MALLET... \$11.00

METAL POLISH

Ludwig's metal polish is specifically formulated to protect cymbals and to keep them new looking for lasting beauty.

No. 528—METAL POLISH \$2.00



PAISTE CYMBAL CLEANER

Ideal for keeping cymbals clean and new looking for years. This new formula keeps cymbals gleaming without any scratching or marring.

No. 530—PAISTE CYMBAL CLEANER \$2.50

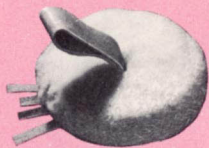

LAMB'S WOOL CYMBAL HOLDER

A deluxe lamb's wool cymbal pad with leather thongs. Easy on the hands while providing perfect cymbal action.

No. 1365—CYMBAL HOLDERS, pair \$7.50

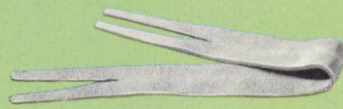

LEATHER THONGS

Sturdy, yet soft and flexible, these leather thongs perform perfectly in concert use when tied to the cymbals. These are traditionally the ideal holders for minimum muting of the cymbal sound.

No. 1366—LEATHER THONG, each \$.60

GONG COVERS

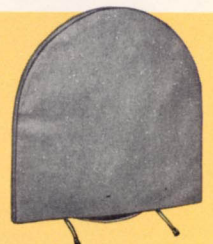

Full drop, fleece lined Mackintosh covers provide maximum protection of gongs from dust and damage. Also, they discourage misuse when gongs are not being played in practice or performance.

- No. 764-1—GONG COVER FOR NO. 764 STAND
 - No. 762-1—GONG COVER FOR NO. 762 STAND
 - No. 763-1—GONG COVER FOR NO. 763 STAND
- } \$12.00



WOOD HANDLE CYMBAL HOLDERS

A solid, hard wood handle that bolts to the cymbal. Plastic loop provides a sure grip.

No. 358—WOOD HANDLE CYMBAL HOLDERS, pair. \$2.75



PLASTIC CYMBAL HOLDERS

Leather thongs with plastic pads provide the ideal holder for good cymbal response and tone.

No. 1367—PLASTIC CYMBAL HOLDERS, pair. \$4.00

ZIPPER CYMBAL POUCH



Here is an extremely NEW design in cymbal pouches. Sturdy, leatherette finish, attractively stitched with zipper opening. Completely dustproof. Convenient to carry on the march.

- No. 1387—18" DIA. ZIPPER LEATHERETTE CYMBAL POUCH \$19.75
- No. 1389—24" DIA. \$26.50

LUDWIG *wire brushes*

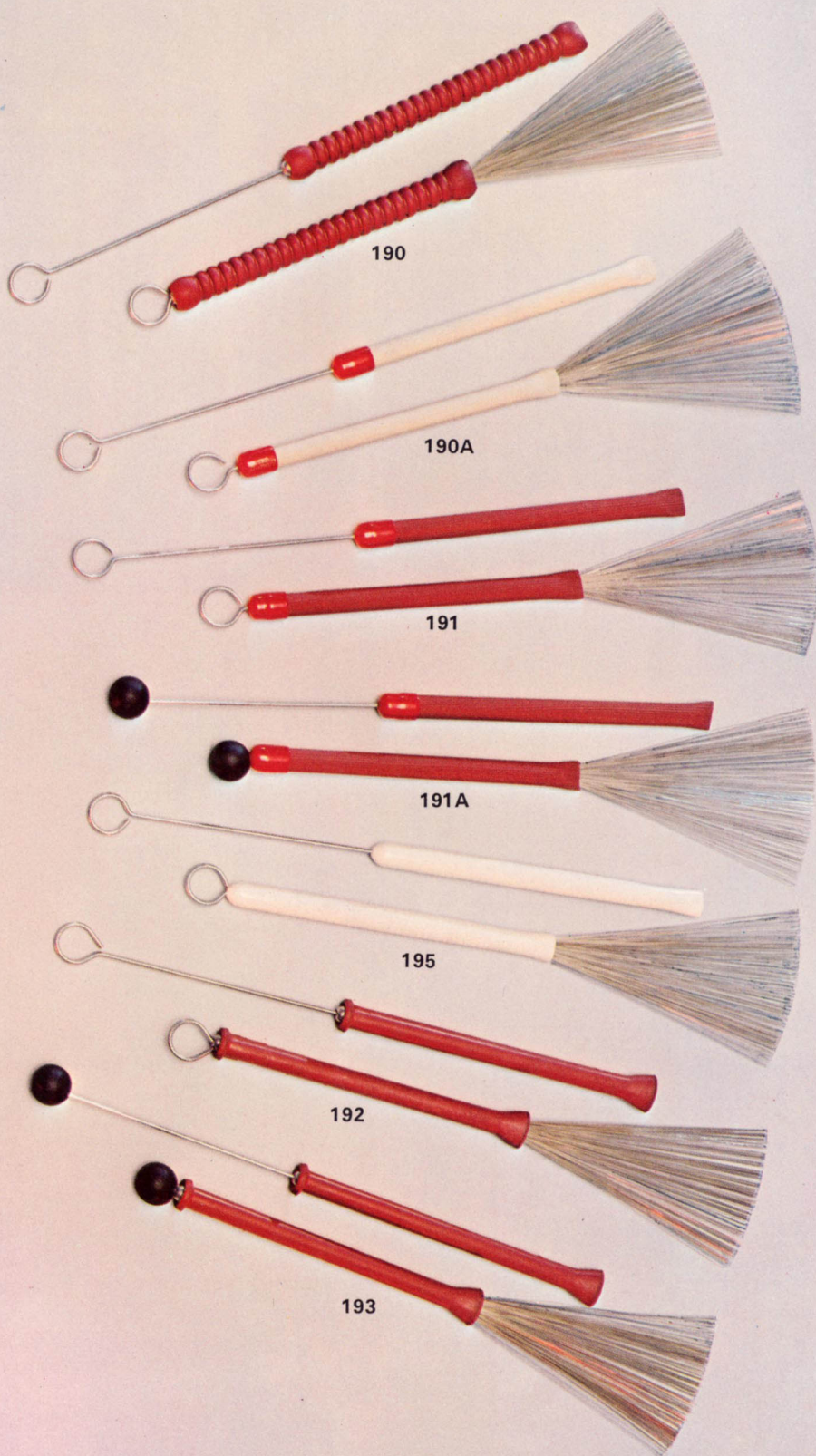

Ludwig offers the largest and most complete line of wire brushes available today. This wide selection provides each player with THE brush for his particular needs. Each model has been carefully designed for correct balance and is constructed of only the finest materials. Wires will not drop out and are machine-fanned to the proper width. Follow the top professionals—select your favorite model from the quality line of Ludwig brushes.

No. 190—RED RIBBED MODEL

Handle is molded approximately to same diameter as the average dance model drum stick. Deep ribs prevent slipping or turning while in use and provide added weight for cymbal work.

No. 190—RED RIBBED MODEL, pair \$2.60

NO. 190A—WHITE RUBBER MODEL

Here's the most popular of all! Small, smooth white rubber handle especially designed for circular press rolls and small combo work.

No. 190A—WHITE RUBBER MODEL, pair \$2.60

NO. 191—RED GROOVED MODEL

A favorite among top drum stars. Grooves prevent turning while in use. Slim handle fits comfortably between fingers.

No. 191—RED GROOVED MODEL, pair \$2.60

NO. 191A—BALL END GROOVED MODEL

Grooved red rubber handle prevents turning while in use. Ball end is designed for cymbal and tom tom use.

No. 191A—BALL END GROOVED MODEL, pair \$2.60

NO. 195—WHITE PLASTIC MODEL

The new white plastic model provides a sure-grip, slim handle designed for solid rim shot work.

No. 195—WHITE PLASTIC MODEL, pair \$2.75

NO. 192—MOLDED RED RUBBER MODEL

A fine performing model with molded form-fitting rubber handle that will not slip in use. Live rubber handle is ideal for cymbal work.

No. 192—MOLDED RED RUBBER MODEL, pair \$2.60

NO. 193—BALL END MOLDED MODEL

Molded red rubber handle with ball end for cymbal and tom tom use. Thick flange at end provides solid sock beats.

No. 193—BALL END MOLDED MODEL, pair \$2.90

LUDWIG *matched snare drum sticks*

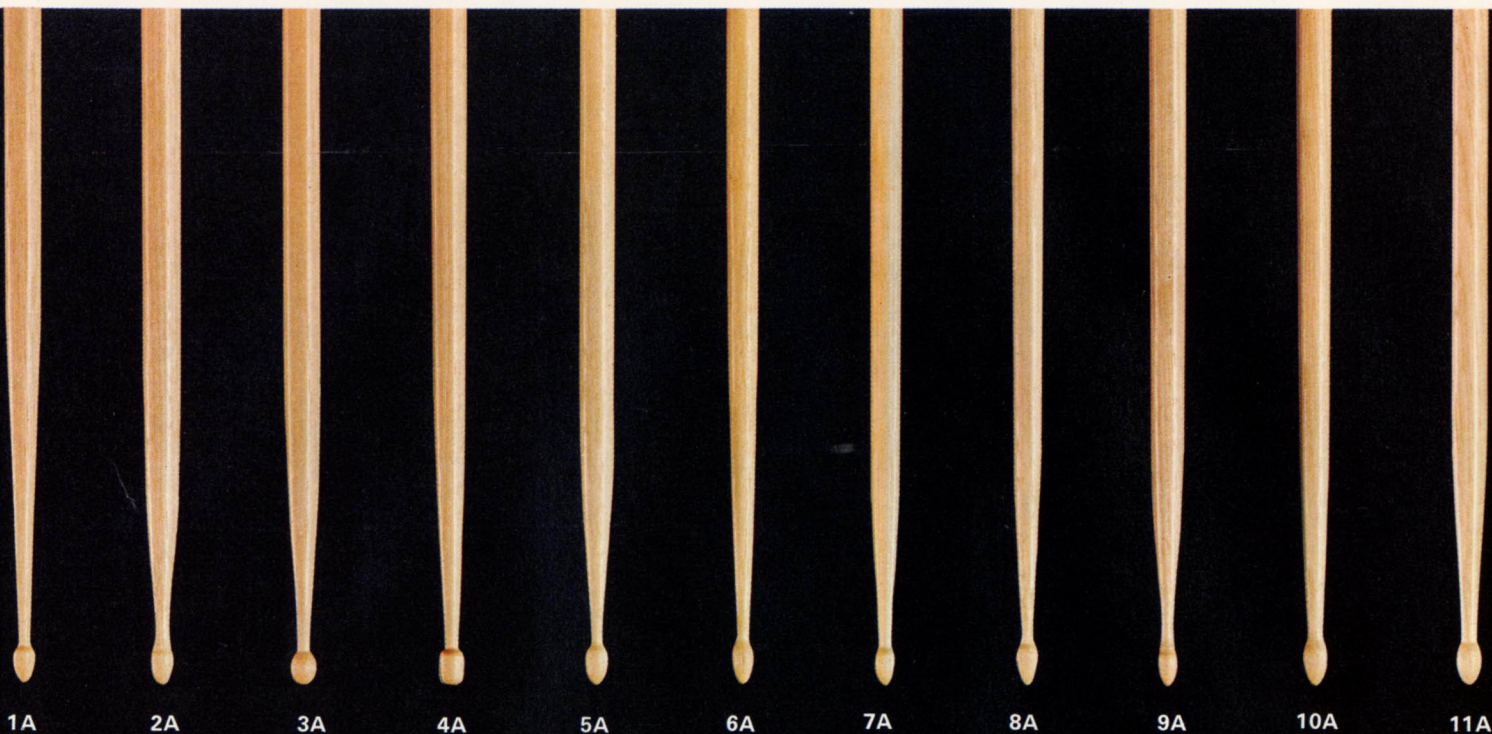

HICKORY STICKS PRICE: \$1.80 PER PAIR

Ludwig hickory snare drum sticks are cut from select close-grained hickory dowels, carefully sanded, filled, properly identified and satin lacquer finished. Sticks are checked for warp and defects before being paired and sealed in air-tight plastic bags. Bead shape, neck thickness, shoulder taper, stick length and shaft diameter are approximate.

MODEL NUMBERS AND DESCRIPTION

- No. 1A — Acorn bead, thin neck, long shoulder taper, length 16 $\frac{3}{4}$ " x $\frac{9}{16}$ " diameter.
- No. 2A — Medium olive bead, medium neck, moderately short shoulder taper, length 15 $\frac{3}{4}$ " x $\frac{5}{8}$ " diameter.
- No. 3A — Small ball bead, moderately thin neck, moderately long shoulder taper, length 15 $\frac{5}{8}$ " x $\frac{9}{16}$ " diameter.
- No. 4A — Capsule bead, medium neck, long shoulder taper, length 15 $\frac{5}{8}$ " x $\frac{9}{16}$ " diameter.
- No. 5A — Medium olive bead, thin neck, moderately long shoulder taper, length 16" x $\frac{9}{16}$ " diameter.
- No. 6A — Small olive bead, thin neck, long shoulder taper, length 15 $\frac{1}{2}$ " x $\frac{3}{8}$ " diameter.
- No. 7A — Roy Haynes model, medium olive bead, thin neck, moderately short shoulder taper, length 15 $\frac{1}{4}$ " x $\frac{1}{2}$ " diameter.
- No. 8A — Acorn bead, thin neck, long shoulder taper, length 15 $\frac{5}{8}$ " x $\frac{3}{8}$ " diameter.
- No. 9A — Moderately large olive bead, medium neck, short shoulder taper, length 15 $\frac{3}{4}$ " x $\frac{5}{8}$ " diameter.
- No. 10A — Ray McKinley model, moderately large olive bead, medium neck, long shoulder taper, length 15 $\frac{5}{8}$ " x $\frac{1}{2}$ " diameter.

NYLON TIPS PRICE: \$2.30 PER PAIR

All Ludwig stick models except No. 4S and No. 7B are available with nylon tips at additional cost; add 50¢ to the price of a pair of sticks.

**When ordering, specify "N" after the model number.*

Nylon tips are supplied in three sizes to correspond with the "A", "B" and "S" models.

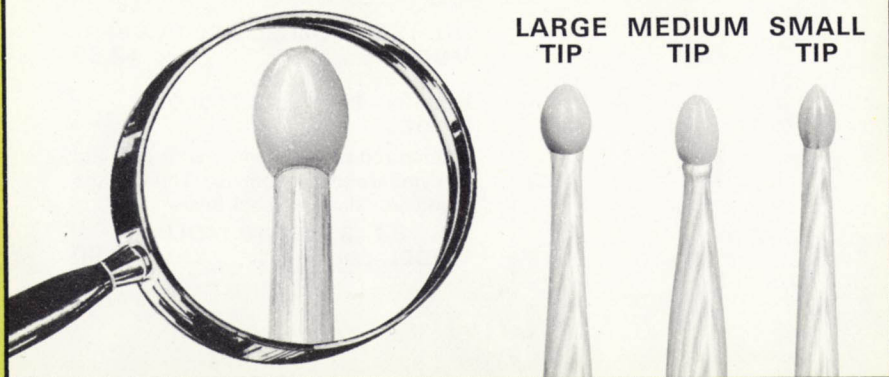

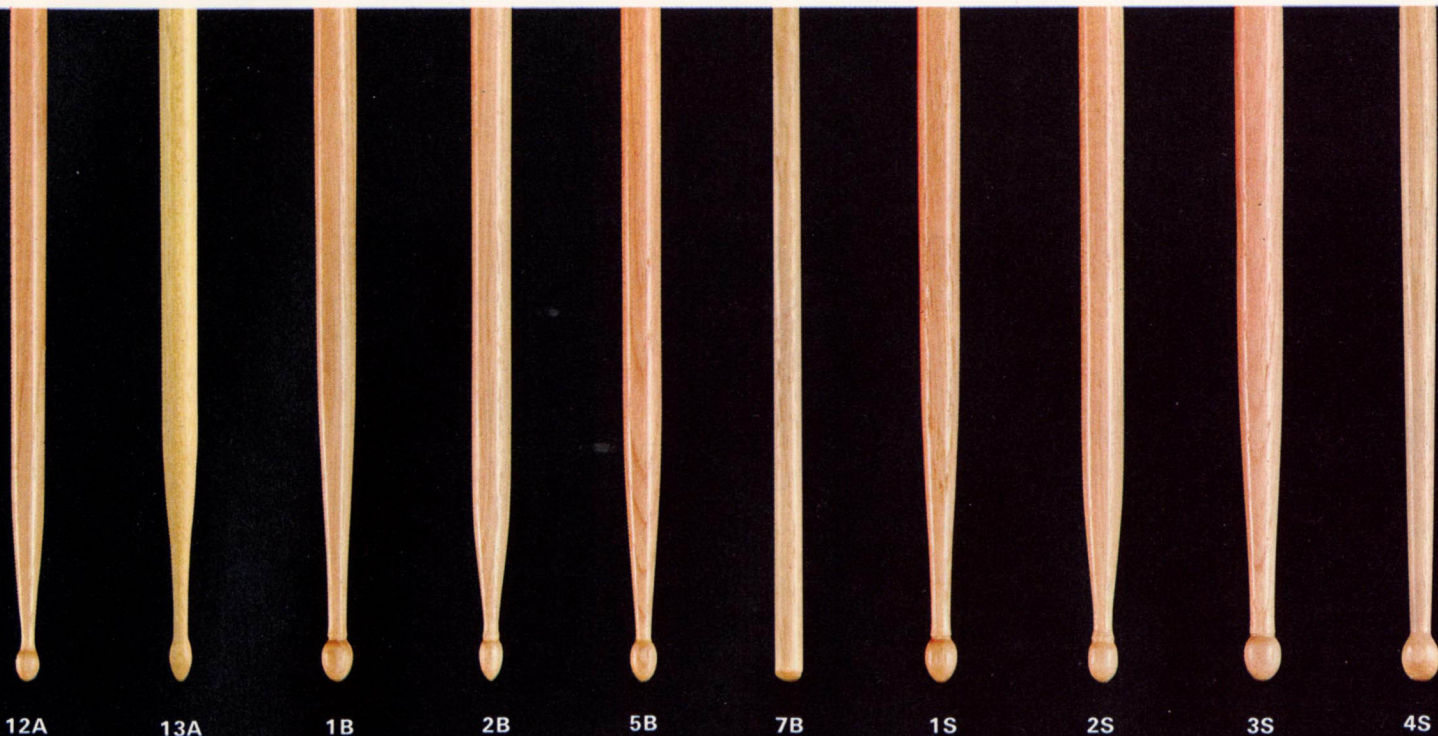

- No. 11A—Joe Morello model, medium olive bead, moderately thin neck, moderately short shoulder taper, length $15\frac{3}{8}$ " x $\frac{1}{2}$ " diameter.
- No. 12A—Jo Jones model, acorn bead, thin neck, short shoulder taper, length $14\frac{3}{4}$ " x $\frac{9}{16}$ " diameter.
- No. 13A—Ringo Starr model, medium large olive bead, medium neck, moderately long shoulder taper, length $15\frac{1}{2}$ " x $\frac{9}{16}$ " diameter.
- No. 1B —Moderately large ball bead, moderately thick neck, long shoulder taper, length $16\frac{3}{8}$ " x $\frac{5}{8}$ " diameter.
- No. 2B—Medium olive bead, medium neck, short shoulder taper, length $15\frac{7}{8}$ " x $\frac{5}{8}$ " diameter.
- No. 5B —Moderately large olive bead, medium neck, moderately long shoulder taper, length 16 " x $\frac{9}{16}$ " diameter.
- No. 7B —Rock Beat model, length 16 " x $\frac{1}{2}$ " diameter.
- No. 1S —Large olive bead, moderately thick neck, long shoulder taper, length $16\frac{7}{8}$ " x $\frac{5}{8}$ " diameter.
- No. 2S —Large ball bead, thick neck, short shoulder taper, length 17 " x $\frac{1}{16}$ " diameter.
- No. 3S —Very large ball bead, very thick neck, moderately long shoulder taper, length $16\frac{7}{8}$ " x $\frac{3}{4}$ " diameter.
- No. 4S —Swiss model, length $16\frac{7}{8}$ " x $\frac{3}{4}$ " diameter.

DRUM SIZES AND SUGGESTED STICK MODELS

- 3" x 13": 6A and 8A
- 4" x 14": 7A, 10A and 11A
- 5" x 14": 3A, 4A, 5A, 12A, 13A and 5B
- $6\frac{1}{2}$ " x 14": 1A, 2A, 9A, 1B, 2B and 7B
- 10" x 14" and 8" x 15": 1B, 2B, and 1S
- 12" x 15" and 12" x 16": 1S, 2S, 3S and 4S

Any of the above stick models can be used on a larger size drum than suggested, and vice-versa.

Select the proper sticks in relation to the size of the drum and the performance activity. For beginners, sticks should be chosen to fit the size of the hand.

LAMO STICKS— PRICE: \$1.80 PER PAIR

Ludwig's revolutionary idea in LAMO drum sticks has met with widespread approval from the percussion world. The Ludwig LAMO stick is carefully turned from a blend of select hardwoods, electrically fused together in uniform layers, resulting in a better stick with better feel, better match, and better tone . . . PLUS warpage resistance! All Ludwig LAMO sticks are available in the same models as hickory and are carefully matched in pairs and sealed in air-tight plastic bags. When ordering, please specify "L" after the number of the stick desired.

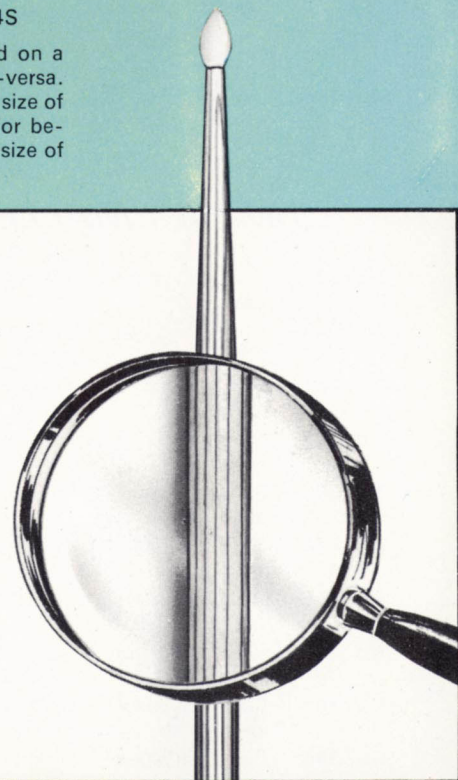

LUDWIG *concert mallets and beaters*

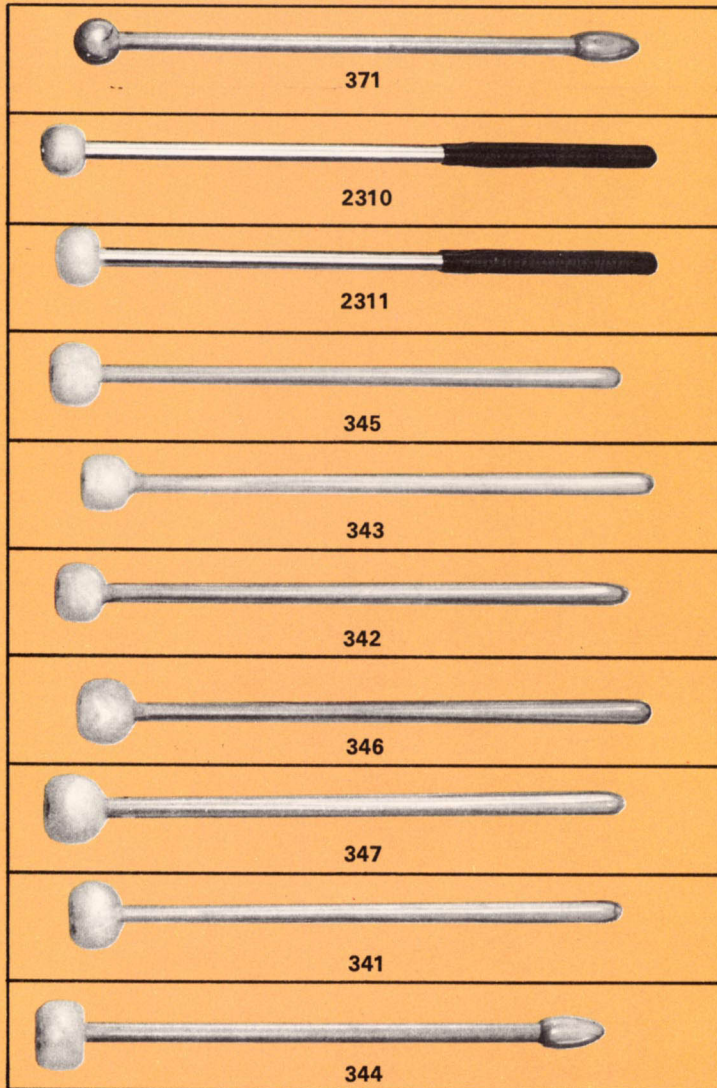

TIMPANI MALLETS

- No. 371 —Balanced double ball end, all wood, per pair \$5.50
- No. 2310—Hard wood ball end, acrolite shaft, moulded grip, per pair \$6.00
- No. 2311—Piano felt sack type end, medium-hard, acrolite shaft, moulded grip, per pair. \$6.00
- No. 345 —Hard felt ball end, medium, wooden shaft, per pair \$5.00
- No. 343 —Piano felt ball end, hard, wooden shaft, per pair. \$5.00
- No. 342 —Piano felt ball end, medium-hard, wooden shaft, per pair. \$5.00
- No. 346 —Piano felt ball end, medium-soft, wooden shaft, per pair \$5.00
- No. 347 —Piano felt ball end, soft, wooden shaft, per pair. \$5.00
- No. 341 —Piano felt cartwheel end, Metzenger model, wooden shaft, per pair. \$5.00
- No. 344 —Piano felt cartwheel end with wooden pear end handle, wooden shaft, per pair. . \$5.50

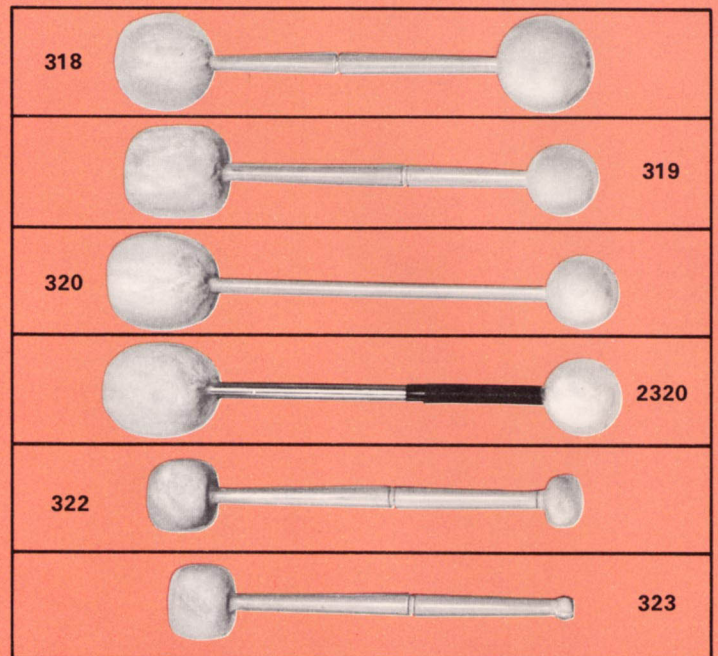

BASS DRUM BEATERS

- No. 318 —Balanced double ball end beater, lambs wool, wooden shaft. \$8.00
- No. 319 —Large and small double end beater, lambs wool, short tapered wooden shaft. . . \$8.00
- No. 320 —Large and small double ball end beater, straight wooden shaft. \$8.00
- No. 2320—Large and small double ball end beater, lambs wool, acrolite shaft, moulded grip \$8.50
- No. 322 —Large and small double ball end beater, hard felt, short tapered wooden shaft. \$7.50
- No. 323 —Large single ball end beater, short tapered wooden shaft. \$6.50

GENERAL INFORMATION

Ludwig mallets, beaters and sticks for timpani, timpani, bass drums, and tenor drums are made from only the finest materials selected for durability and crafted in the Ludwig quality tradition. Piano felt mallets and lambs wool beaters are hand sewn by experts of long experience and are balanced for tonal response.



... marching mallets, beaters and sticks

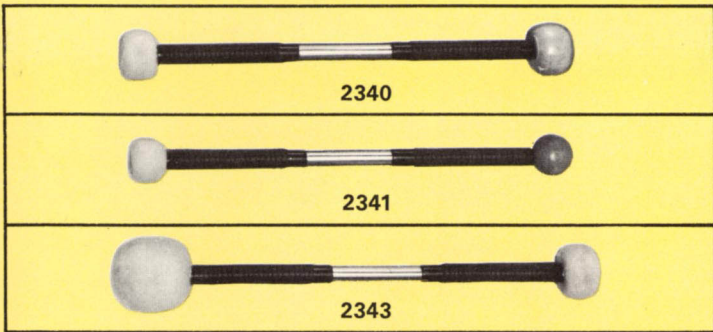

TIMP-TOM MALLETS

- No. 2340—Large, double ball end beaters, wood and felt, acrolite shaft, moulded grip, per pair \$9.50
- No. 2341—Medium, double ball end beaters, wood and felt, acrolite shaft, moulded grip, per pair \$9.00
- No. 2343—Large, double ball end beaters, lambs wool and felt, acrolite shaft, moulded grip, per pair \$9.50

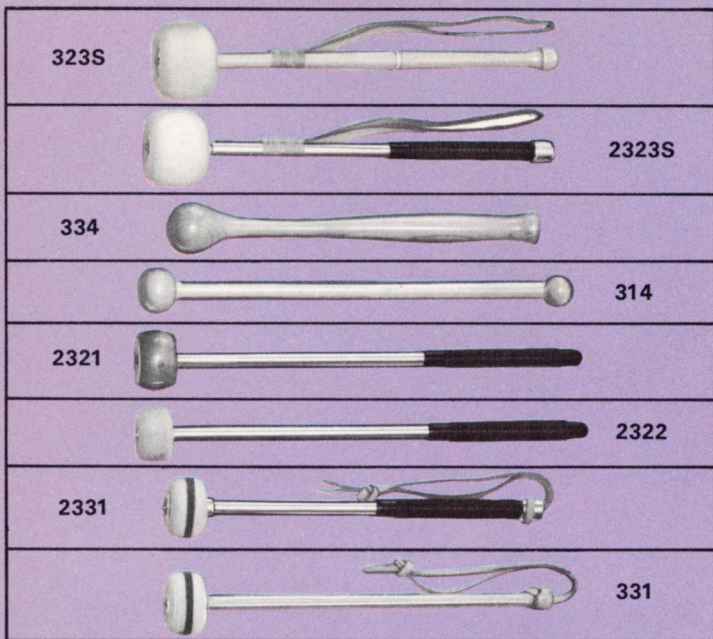

BASS DRUM BEATERS

- No. 323S —Hard felt, ball end beater, wooden shaft with strap \$6.50
- No. 2323S—Hard felt, ball end beater, acrolite shaft with strap \$7.50
- No. 334 —Solid wood beaters, per pair \$6.50
- No. 314 —Double ball end, solid wood beaters, per pair \$8.00
- No. 2321 —Wooden ball end beaters, acrolite shaft, moulded grip, per pair \$8.50
- No. 2322 —Hard felt ball end beaters, acrolite shaft, moulded grip, per pair \$8.50
- No. 2331 —Medium-hard felt, ball end beaters, acrolite shaft with thongs, moulded grip, per pair \$9.00
- No. 331 —Medium-hard felt, ball end beaters, wooden shaft with thongs, per pair \$7.50

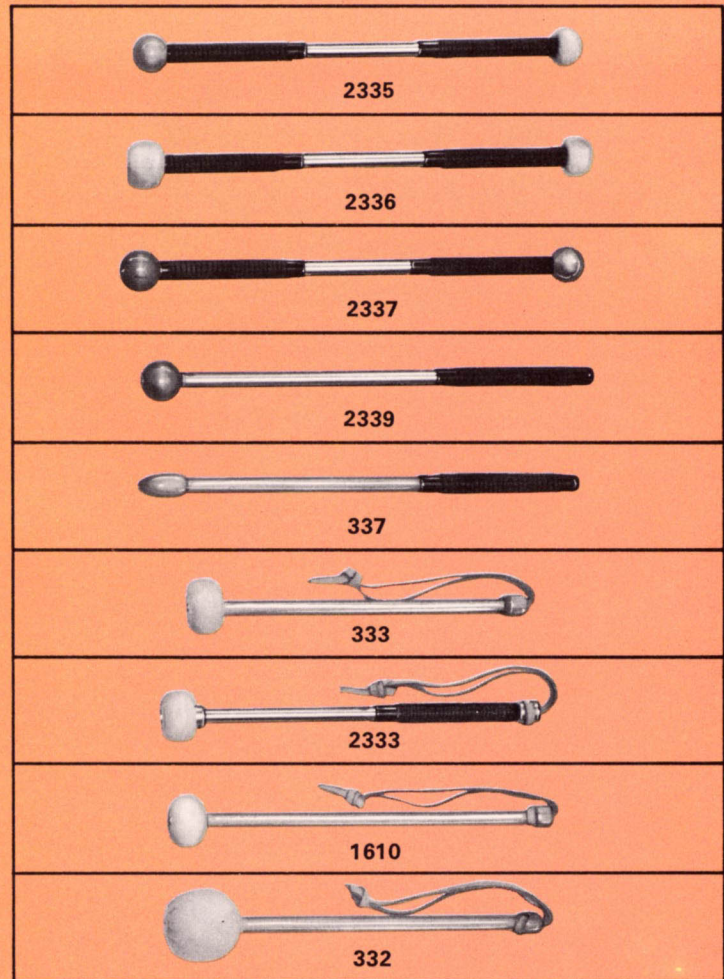

TENOR DRUM STICKS

- No. 2335—Small double ball end beaters, wood and felt, acrolite shaft, moulded grip, per pair \$9.00
- No. 2336—Medium and small double ball end beaters, hard felt, acrolite shaft, moulded grip, per pair \$9.00
- No. 2337—Medium and small double ball end beaters, wooden acrolite shaft, moulded grip, per pair \$9.00
- No. 2339—Wooden ball end beaters, medium, acrolite shaft, moulded grip, per pair \$7.50
- No. 337 —Wooden pear end beaters, small, wooden shaft, per pair \$6.50
- No. 333 —Medium felt ball beaters, wooden shaft with thongs, per pair \$7.00
- No. 2333—Medium felt ball beaters, acrolite shaft with thongs, per pair \$8.50
- No. 1610—Large felt ball beaters, wooden shaft with thongs, per pair \$7.00
- No. 332 —Lambs wool beaters, wooden shaft with thongs, per pair \$8.00

LUDWIG *practice drum pads... stands...and holders*



FAMOUS GLADSTONE PAD

Made of pure gum rubber with steel plate imbedded to make an integral structure. This resilient pad never hardens, cracks or softens. It provides a crisp, live natural drum rebound; two playing surface levels for rim shot, timbales and tom-tom practice. Patented structure establishes a vacuum, holding pad firmly in place on batter head of your snare drum or table. Supplies adequate volume, audible snare response and perfect control.

No. 351—GLADSTONE PAD \$6.00



ALL-METAL PRACTICE PAD

Solid one-piece aluminum with thick, live gum rubber set into playing surface. New suction cup feet provide solid anchor to any surface.

No. 355—METAL PAD . . \$6.00



HEAVY DUTY WOOD PAD

Constructed of select hard woods with thick, live gum rubber set into playing surface. Provides proper stick rebound for years of satisfied service.

No. 355W—HEAVY DUTY PAD \$7.50



ALL-METAL PAD AND ADJUSTABLE STAND

A convenient practice arrangement using the No. 355 pad mounted on height adjustable stand. Pad is easily detachable, stand folds for packing.

No. 2010-1—NO. 355—PAD AND STAND complete \$18.00
No. 1359-1—STAND ONLY for No. 355 Pad 12.00

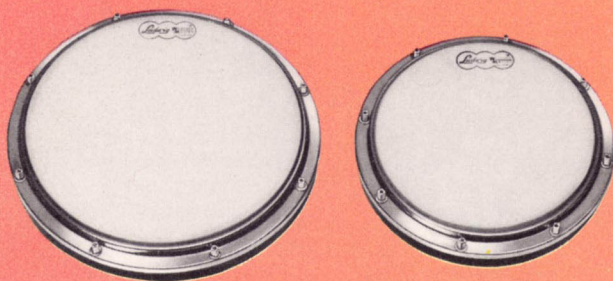

NEW TUNABLE PRACTICE PADS

The very latest in modern design that can be tuned to any desired tension with any standard drum key. They can be used for either stick or brush and provide the touch, feel and rebound of an actual drum. Made of top quality, Weather Master Mylar plastic heads, mounted over a 1" compressed rubber sound insulator with a chrome-plated counter hoop. Rubber bumpers on the solid hardwood base keep the pad from creeping when used on any flat surface. Special insert is imbedded in the base for mounting on floor stand. Select 8" or 10" diameter sizes; replacement heads available.

No. 359—8" TUNABLE PAD \$10.50
No. 360—10" TUNABLE PAD 12.00



ALL-RUBBER PORTO PAD

A handy pocket size practice pad of molded top grade gum rubber. Ideal for use on head of drum. Easy to carry—convenient to use.

No. 354—PORTO PAD . . \$2.50

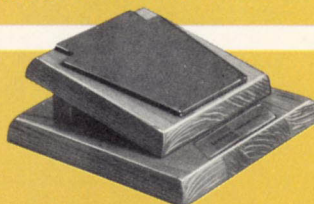

LIGHT-DUTY ECONOMY PAD

A quality low priced pad for the beginning drummer. Live rubber playing surface is mounted on solid angle board and base. Lightweight and easy to carry.

No. 356—LIGHT DUTY PAD \$4.75

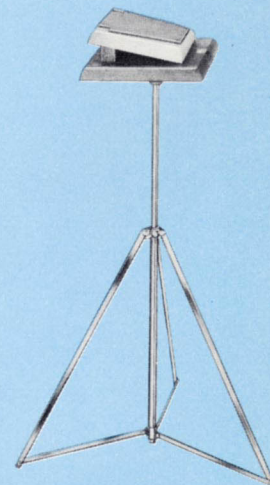

LIGHT DUTY PAD AND ADJUSTABLE STAND

An economy pad and stand for the beginning drummer. The lightweight, detachable pad and folding stand are easily packed in drum case.

No. 2012—NO. 356—PAD AND STAND, complete \$12.75
No. 1361—STAND ONLY for No. 356 pad 8.00

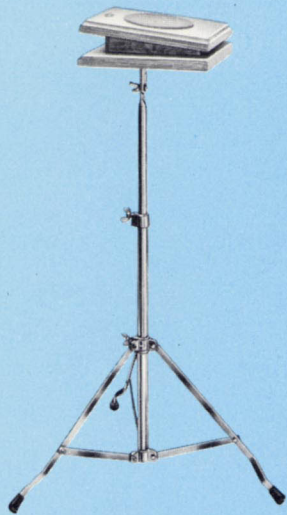

HEAVY DUTY PAD AND ADJUSTABLE STAND

An ideal teaching and practice arrangement using the No. 355W professional pad mounted on sturdy chrome-plated stand. Features complete height and angle adjustment.

No. 2011-1—NO. 355W—PAD AND STAND Comp. \$20.50
No. 1360-1—STAND ONLY for No. 355W Pad. 13.00

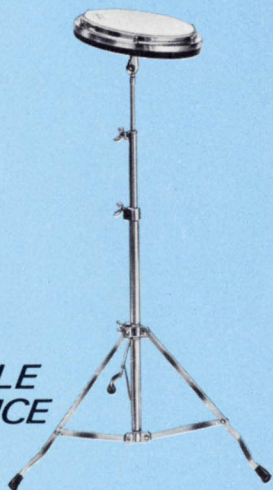

TUNABLE PRACTICE PAD AND ADJUSTABLE STAND

A quality practice pad and stand for professional and amateur drummers alike. Pad is easily detachable; chrome-plated stand folds compactly for packing.

No. 2013—NO. 359—8" TUNABLE PAD AND STAND, comp. . . \$24.00
No. 2014—NO. 360—10" TUNABLE PAD AND STAND, comp. 25.50
No. 1352—STAND ONLY for No. 359 or No. 360 Pad. 13.50

HOOP MOUNT CYMBAL HOLDER

A completely adjustable hoop mount holder with built in cymbal tilter. Holder can be mounted anywhere on your bass drum hoop. New design offers rigid cymbal mounting.

No. 1370—CYMBAL HOLDER with tilter and hoop mount bracket. \$8.00
No. 1371—CYMBAL HOLDER SLEEVE, only; with tilter. 5.50

DISAPPEARING CYMBAL HOLDER

The modern shell mount cymbal holder provides fast, effortless cymbal set-up. Holder simply disappears into bass drum when not in use. Built in tilter offers cymbal angle adjustment.

No. 1380—DISAPPEARING SHELL MOUNT CYMBAL HOLDER with tilter. \$6.50

SHELL MOUNT CYMBAL HOLDER

An entirely new tilting holder with complete height and angle adjustment. New die-cast bracket assures rigid cymbal mounting with modern streamlined appearance.

No. 1372—CYMBAL HOLDER with tilter and shell mount bracket. \$8.50
No. 1373—CYMBAL HOLDER WITHOUT tilter and shell mount bracket (not illustrated). \$8.00

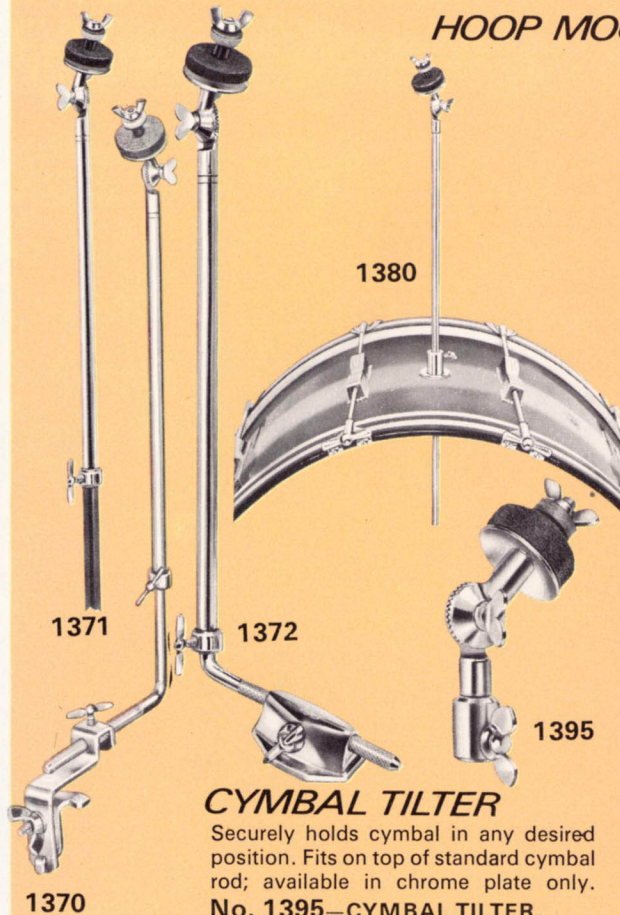

CYMBAL TILTER

Securely holds cymbal in any desired position. Fits on top of standard cymbal rod; available in chrome plate only.

No. 1395—CYMBAL TILTER, only (securely fits on top of standard cymbal rod). \$3.00

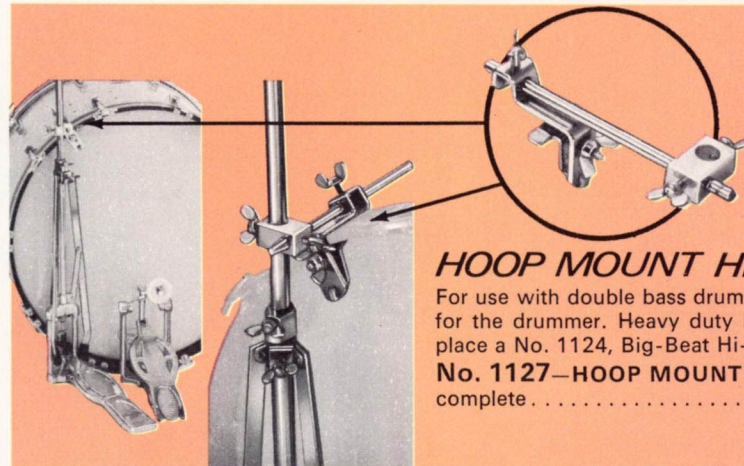

HOOP MOUNT HI HAT BRACE

For use with double bass drum outfits; assures playing ease for the drummer. Heavy duty brace supports and holds in place a No. 1124, Big-Beat Hi-Hat pedal.

No. 1127—HOOP MOUNT HI-HAT BRACE, complete. \$7.00

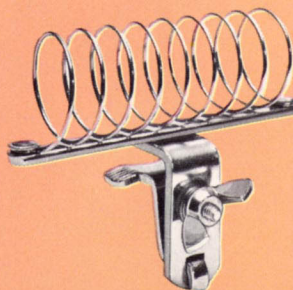

HOOP MOUNT STICK HOLDER

Sticks, brushes or mallets can be securely held in place and within easy reach of the drummer.

No. 1324—HOOP MOUNT STICK HOLDER. \$4.60



CONCERT TAMBOURINES

Ludwig tambourines are made under strict factory specifications. Shells are of selected hardwood, hand sanded and lacquered in a natural finish. Jingles are uniformly stamped from the most resonant metals; only calf skin heads are used and sprayed with Ruff-Kote head spray for easy finger rolls.

| | |
|--------------------------------------------------------------------------|---------|
| No. 71—7" DIAMETER TAMBOURINES, single row jingles (5 prs.) | \$10.00 |
| No. 94—8" DIAMETER TAMBOURINES, single row jingles (7 prs.) | 12.00 |
| No. 95—10" DIAMETER TAMBOURINES, single row jingles (8 prs.) | 14.00 |
| No. 95A—10" DIAMETER TAMBOURINE, double row jingles, (16 prs.) | 16.00 |
| No. 93—TAMBOURINE JINGLES, per dozen | 2.00 |

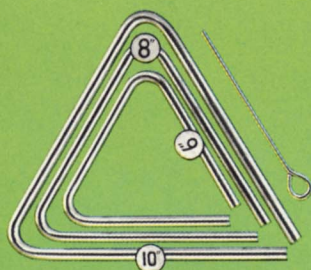

CONCERT TRIANGLES

Ludwig professional quality Triangles are made of top grade steel to provide the finest sound quality possible. Each triangle is carefully plated to prevent rusting and is permanently mounted to a Triangle Clip Holder.

| | |
|-----------------------------------------|--------|
| No. 1333—6" CLEAR TONE TRIANGLE | \$8.00 |
| No. 1334—8" CLEAR TONE TRIANGLE | 8.50 |
| No. 1332—10" CLEAR TONE TRIANGLE | 9.00 |

(Prices include beater)

TUNABLE WOOD SHELL TAMBOURINES

Ludwig provides two sizes in wood shell tambourines with tunable heads. Both the 8" and 10" are supplied with durable plastic heads, which are easily tuned to desired pitch and feel with special key. Select hardwood shells are carefully sanded and finished; special tension hooks provide even head tensioning; heads are evenly sprayed with Ruff-Kote for effective, easy thumb rolls. Ludwig 10" wood shell tambourines are available in a choice of single or double row jingles.

| | |
|------------------------------------------------------------------------------------------|---------|
| No. 72—8" DIAMETER WOOD SHELL TUNABLE TAMBOURINE, single row jingles (7 prs.) | \$12.00 |
| No. 99—10" DIAMETER WOOD SHELL TUNABLE TAMBOURINE, single row jingles (8 prs.) | 14.00 |
| No. 99A—10" DIAMETER WOOD SHELL TUNABLE TAMBOURINE, double row jingles, (16 prs.) | 16.00 |
| No. P2710—TUNING KEY | .50 |

TUNABLE ALL-METAL TAMBOURINES

Ludwig's all-metal tambourines offer a lightweight, yet extremely durable instrument that produces a bright, clear, crisp, ringing effect resulting from the play of metal on metal. The added features of heavy-duty hoops and strong plastic heads are ideal for today's modern music. Nine individually adjustable tension hooks easily tension the head with the special key to provide the desired feel and pitch. Heads are specially sprayed with Ruff-Kote to facilitate clean, easy thumb rolls. Here is the finest tambourine for those who want to add a new sound quality to their percussion section.

| | |
|-------------------------------------------------------------------------------|---------|
| No. 98—10" ALL-METAL TUNABLE TAMBOURINE, single row jingles (8 prs.) | \$16.00 |
| No. 98A—10" ALL-METAL TUNABLE TAMBOURINE, double row jingles (16 prs.) | 19.00 |
| No. P2710—TUNING KEY | .50 |

ELTON FINGER CYMBALS

Professional quality Finger Cymbals are designed to provide a clear, ringing tone that blends and accents any composition. Ideal for special effects!

| | |
|----------------------------------------------|--------|
| No. 85—ELTON FINGER CYMBALS, pair (2) | \$7.00 |
|----------------------------------------------|--------|



TRIANGLE CLIP HOLDER

This Clip Holder, equipped with strong cord, fits all music stands and is designed to enhance the resonant quality of the triangle. Triangle beater fits into holes in handle.

| | |
|--------------------------------------|--------|
| No. 1336—TRIANGLE CLIP HOLDER | \$1.50 |
|--------------------------------------|--------|



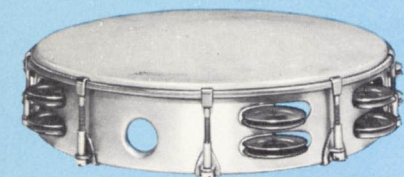

CASTANETS

Nothing conveys the impression of a crisp, Spanish dance like these fine, professional style Castanets. Durable plastic clappers are carefully mounted on hardwood handles to provide the maximum resonance and tone quality. Ludwig Castanets can be either hand or finger controlled.

- No. 90—HAND CASTANETS, set of four clappers..... \$2.80
- No. 91—SINGLE PAIR CASTANETS ON HANDLE 3.30
- No. 92—DOUBLE PAIR CASTANETS ON HANDLE 4.30

STANDARD WOOD BLOCKS

Carved from select hardwood to provide a clear, resonant tone, these Ludwig Wood Blocks are ideal for rhythmic and novelty effects. Available in two sizes.

- No. 774—LARGE WOOD BLOCK..... \$3.50
- No. 775—SMALL WOOD BLOCK..... 3.00



TUNABLE TONE BLOCK

Ludwig's Tunable Tone Block is made of durable, black ebonite for long-lasting service and clear tone. Block is tuned by moving pins together for higher tones or apart for lower tones.

- No. 777—TUNABLE TONE BLOCK..... \$3.50
- No. 773—SINGLE BLOCK HOLDER..... 3.00



CONCERT TRAP TABLE

The Concert Trap Table is designed to hold accessory instruments, sticks and beaters for convenient, immediate use. Felt covered table top measures 18" x 24" overall. Heavy-duty, chrome-plated stand folds for easy packing; complete height adjustment offers use in standing or sitting position. A "must" for every percussion section!

- No. 1378—CONCERT TRAP TABLE, complete..... \$40.00
- No. 1379—TABLE TOP ONLY..... 10.00
- No. 1368—ORCHESTRA BELL STAND ONLY.. 30.00

CONCERT CASTANETS



Ludwig Concert Castanets offer professional mounting for school band and orchestra performance. Exclusive design provides instant, trouble-free response when played with fingers or soft mallets. Strong Bakelite castanets resonate against select rosewood mounting block for ideal effect.

- No. 89—CONCERT CASTANETS..... \$7.50

PICCOLO WOOD BLOCK

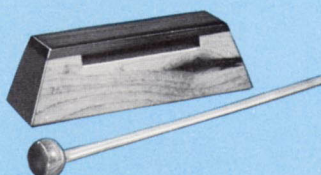

Vital for special effects and modern orchestral work, this Wood Block is very high pitched. For the most effective sound, a special Piccolo Wood Block Striker is available. Equipped with standard mounting holes and felt pads.

- No. 2396—PICCOLO WOOD BLOCK.... \$3.95
- No. 2397—PICCOLO WOOD BLOCK STRIKER..... .50

LUDWIG

special effect percussion instruments



BIRD WHISTLE

For effective bird call imitation. For proper effect, fill half full with water; all metal.

No. 537-1—BIRD WHISTLE . . . \$8.00

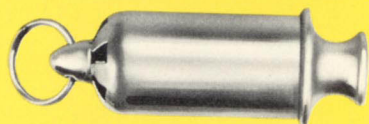

ACME SIREN

Use as wind whistle, siren whistle or cyclone. Delivers clear, high pitched tones. Made in England; all metal plated with ring for hooking on music stand.

No. 539—ACME SIREN \$5.00

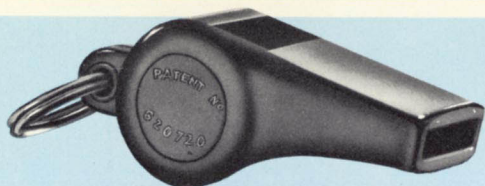

PLASTIC WHISTLE

Produces an unusually high pitched sound for special whistle effects. Molded of hard and durable black plastic.

No. 542—PLASTIC WHISTLE . \$1.00

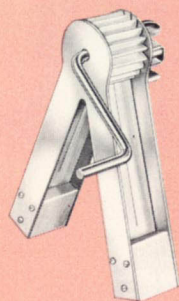

RATCHET

Made of select hardwoods with plated metal sides for more durable performance. Mounts on bass drum hoop.

No. 75—RATCHET . . . \$7.50



SLAPSTICK

Top quality, hard wood activated by a strong spring to produce the desired "whip" sound. A must for the modern percussion section.

No. 74—SLAPSTICK \$6.00



WRIST BELLS

Four resonant sleigh bells securely fastened to a wrist strap; provides accurate rhythmic manipulation.

No. 96—WRIST BELLS \$1.20

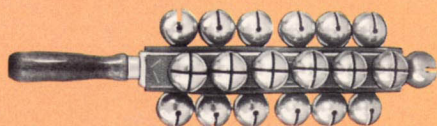

SLEIGH BELLS

Ideal for concert use in many descriptive numbers as well as for the new sounds of today. Set of 25 is mounted on a strong handle.

No. 97—SLEIGH BELLS \$12.00



ORCHESTRA WHISTLE

Creates realistic tugboat and train effects. This triple tone whistle is the perfect addition to the percussion section for unusual sound effects.

No. 543—ORCHESTRAL WHISTLE, all metal \$5.50

No. 544—ORCHESTRAL WHISTLE, metal with plastic mouthpiece. 4.50

No. 545—ORCHESTRAL TRAIN WHISTLE 14.00

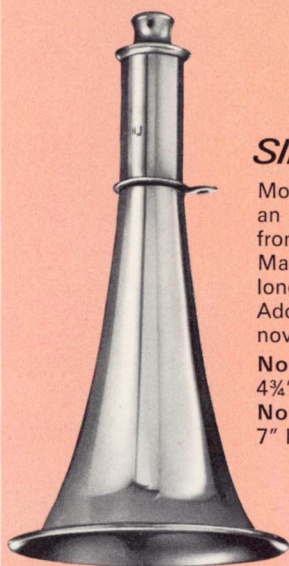

SIREN HORNS

Mouth operated to produce an authentic siren sound from a small instrument. Made of stainless steel for long life and perfect tone. Adds a surprising effect for novelty and arrangements.

No. 546—SIREN HORN, 4 3/4" long \$10.00

No. 547—SIREN HORN, 7" long 11.00



SONG WHISTLE

Ideal for glissando and special effects. All metal, chrome plated finish assures long-lasting use.

No. 536—SONG WHISTLE \$5.00

ANVIL

Perfect for descriptive numbers. Comes complete with anvil, folding stand, mallet and case.

No. 4115—Anvil only \$14.00

No. 4117A—Stand only 3.00

No. 4120A—Mallet only 2.00

No. 4121—Case only 4.50

No. 541—Anvil, complete outfit . . . 23.00

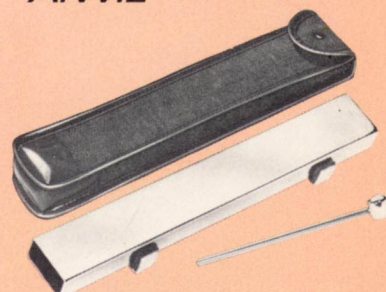

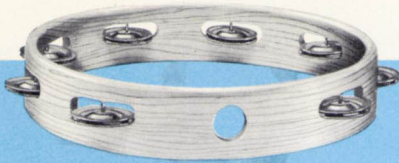

HEADLESS ROCK TAMBOURINE

Produces a strong, crisp jingle effect for the big "rock" sound. Hand-sanded, extra-strong shell is supplied as listed below. When not used on the hi-hat, this tambourine can be used in the hands for solid, effective beat.

No. 94-1—8" Headless Rock Folk Tambourine, single row, (7pr.) jingles..... \$7.00

No. 95-1—10" Headless Rock Folk Tambourine, single row, (8 pr.) jingles..... 8.00

No. 95-2—10" Headless Rock Folk Tambourine, double row (16 pr.) jingles..... 9.00

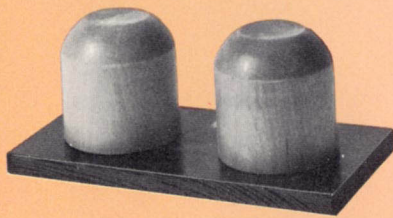

HORSES HOOFS

Reproduces the authentic galloping sound for many orchestral compositions. Consists of two, 2" diameter by 2 3/4" high, natural finish wood shells and 4" x 8" laminated walnut baseboard.

No. 2394—HORSES HOOFS..... \$4.80

HI-HAT SOCK JINGLE

Gives the Rock drummer added "Big Beat" coloring of the popular tambourine jingle effects. Solid rock maple shell with 8 double jingles, mounts easily on any standard hi-hat. Metal plate across tambourine keeps instrument in place; equally effective with after-beat hi-hat or sticks.

No. 88—HI-HAT SOCK JINGLE..... \$8.00

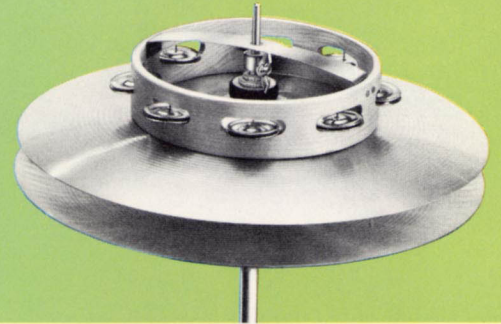

CHING RING

8 jingles bounce to produce unusual sounds and resonating rings. Use on hi-hat cymbals or by hand. Adjustable mounts; chrome finish, 7" diameter.

No. 73—CHING RING..... \$11.00

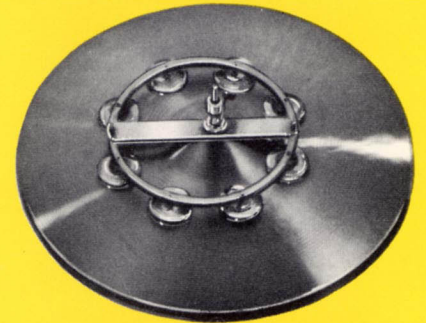

CYMBAL SIZZLER

Produces sizzling sound on your standard cymbal. Easy to mount, chrome finish. No rivets needed in cymbal.

No. 1396—CYMBAL SIZZLER..... \$4.50

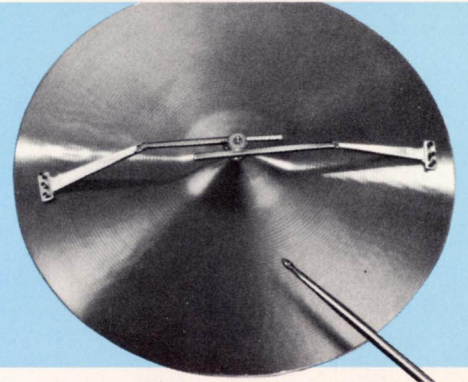

TRAP TREE

Easily attaches to bass drum cymbal mount. Comes complete as illustrated with 6" triangle, 8" cymbal, finger cymbal and trap tree.

No. 1375 TRAP TREE complete.... \$25.00

No. 1386 TRAP TREE only... \$9.00



ROCK FOLK JINGLE STICK

Plays by striking the back of the stick against the hand offering a new "beat" for the modern group. Five double tambourine jingles are mounted on the lamo wood handle.

No. 84—ROCK FOLK JINGLE STICK..... \$5.00



POP GUN

Reproduces genuine "pop" sound for humorous or shock effect. 26" long tube, chrome finish; wooden ball handle plunger and cork.

No. 2395—POP GUN..... \$19.95

LUDWIG weather master "thermolene"® plastic heads



As a result of extensive research and years of testing, LUDWIG now offers you a complete *new* line of polyester heads especially crafted to meet the playing needs of today's drummers and timpanists.

Each head has been subjected to a series of tests designed to determine tonal output . . . response, resonance and clarity of definition, to provide the exact acoustical properties required by the performing group.

Ludwig's *new* line of plastic heads are made on special machines designed and built by Ludwig engineers to assure controlled, consistent sound quality for the best in musical performance.

LUDWIG

offers the *newly* crafted "thermolene"® plastic heads in a series of five different weights:

db-300

a *very light* weight translucent, ultra-sensitive head, designed for use as a snare head, only.

db-500

a *light* weight, milk white, very sensitive head, designed for use as an orchestral batter head, only. The playing surface is coated with Ludwig's *new* formula "Ruff-Kote" finish. Properly tensioned, the head will produce a very dry, crisp sound. Recommended for very fine, delicate playing.

db-750

a *medium*, multi-purpose weight, milk white, sensitive head, designed for use as a batter head only. Ideal for concert*, L-A timbale* playing. This medium weight batter head is also used on the tunable tambourines and is standard on the tunable practice pads. (*The playing surface is coated with Ludwig's *new* formula "Ruff-Kote" finish.)

The db-750 head weight is standard, on all Ludwig's timpani, timp-toms, concert toms, congas and bongos, unless otherwise specified; however, the playing surface is *smooth* and the underside is especially treated for the best in tonal resonance and definition. The tonal response of these heads allows for a wide range of tunings. Bongo and Conga heads have permanently formed deep collars.

db-1000

a *heavy* multi-purpose weight, milk white head, designed for use as a batter head, only. Ideal for concert*, tom-tom* and parade use, where greater volume is needed. This head offers greater resistance and durability to the high impact from sticks and mallets. (*The playing surface is coated with Ludwig's *new* formula "Ruff-Kote" finish.) The playing surface for the parade heads is *smooth*.

The db-1000 head weight is standard on all bass drums, unless otherwise specified; however, the playing surface is *smooth*.

db-1250

an *extra heavy* multi-purpose weight, milk white head, designed for use as a batter head, only. Ideal for rock* and drum corps where heavy impact is necessary for performance. Tonal response is excellent, duration-short, resonance-clear and high pitched, projection-powerful. (*The playing surface is coated with Ludwig's *new* formula "Ruff-Kote" finish.) The playing surface for the drum corps heads is *smooth*.

"thermolene"® plastic heads

Ludwig's "thermolene"® plastic heads are made from a high grade of polyester film, having remarkably great toughness and high impact strength. In addition, this polyester film has a very low water absorption and excellent dimensional stability over a wide range of temperatures and humidity. This material, discovered in 1941, was later developed and applied exclusively by Ludwig to drum head construction.

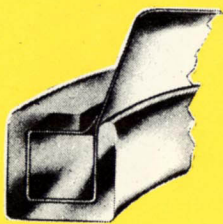

Patented mechanically sealed mounting is guaranteed not to pull out. This assures many years of trouble-free use.

Pat. No. 2979981

New, improved collar is designed for easier mounting, faster "seating", more permanent tensioning. Rounder and deeper for more responsive and resonant sound.

RUFF-KOTE HEAD SPRAY

Roughens plastic batter heads for perfect wire brush response; ideal for tambourine thumb rolls. Plastic heads should be cleaned often with soap and water, scrubbing vigorously with a stiff brush; dry carefully. Apply thin coating of "Ruff-Kote" spray, when required. Allow at least 12 hours for drying.

No. 5—LUDWIG
"RUFF-KOTE"
AEROSOL CAN . . . \$1.25



BATTER HEAD WEIGHTS

| Diameters: | 6" | 8" | 10" | 12" | 13" | 14" | 15" | 16" | 17" | 18" | 20" | 22" | 24" | 26" | 28" |
|-----------------------------|--------|--------|--------|--------|--------|--------|--------|--------|--------|--------|---------|---------|---------|---------|---------|
| THIN | | | | | | | | | | | | | | | |
| Orchestra* | — | — | — | — | OR-13 | OR-14 | OR-15 | — | — | — | — | — | — | — | — |
| MEDIUM | | | | | | | | | | | | | | | |
| Concert*/Tom-Toms*/Timbale* | CT-6 | CT-8 | CT-10 | CT-12 | CT-13 | CT-14 | CT-15 | CT-16 | CT-17 | CT-18 | CT-20 | — | — | — | — |
| Tambourine*/Practice Pad* | — | TA-8 | TA-10 | — | — | — | — | — | — | — | — | — | — | — | — |
| Timp-Toms/Concert Toms | TI-6 | TI-8 | TI-10 | TI-12 | — | TI-14 | — | TI-16 | — | TI-18 | TI-20 | TI-22 | TI-24 | TI-26 | TI-28 |
| HEAVY | | | | | | | | | | | | | | | |
| Concert*/Tom-Toms* | — | — | — | TO-12 | TO-13 | TO-14 | TO-15 | TO-16 | TO-17 | TO-18 | TO-20 | — | — | — | — |
| Parade | — | — | — | — | — | PA-14 | PA-15 | PA-16 | PA-17 | PA-18 | — | — | — | — | — |
| EXTRA HEAVY | | | | | | | | | | | | | | | |
| Rock* | — | — | — | RO-12 | RO-13 | RO-14 | RO-15 | RO-16 | — | RO-18 | RO-20 | — | — | — | — |
| Drum Corps | — | — | — | — | — | DC-14 | DC-15 | DC-16 | DC-17 | DC-18 | — | — | — | — | — |
| Prices: | \$4.50 | \$5.00 | \$5.50 | \$6.50 | \$7.00 | \$7.50 | \$8.00 | \$8.50 | \$9.00 | \$9.50 | \$10.50 | \$11.50 | \$12.50 | \$13.50 | \$14.50 |

Please order by catalog number as listed above

*The playing surface is coated with Ludwig's new formula "Ruff-Kote" finish.

SNARE HEAD WEIGHT

| Diameters: | 6" | 8" | 10" | 12" | 13" | 14" | 15" | 16" |
|------------------------------|----|----|-----|-----|--------|--------|--------|--------|
| EXTRA-THIN | | | | | | | | |
| All Concert and Parade Drums | — | — | — | — | S-13 | S-14 | S-15 | S-16 |
| Prices: | | | | | \$6.00 | \$6.50 | \$7.00 | \$7.50 |

SPECIAL HEAD WEIGHT

| Diameters: | 6" | 8" | 10" | 12" | 13" | 14" | 15" | 16" |
|------------|--------|--------|-----|--------|-----|-----|-----|-----|
| MEDIUM | | | | | | | | |
| Bongos | BO-6 | BO-8 | — | — | — | — | — | — |
| Conga | — | — | — | CO-12 | — | — | — | — |
| Prices: | \$6.50 | \$7.00 | — | \$7.50 | — | — | — | — |

Please order by catalog number as listed above

BASS DRUM HEAD WEIGHTS

| Diameters: | 18" | 20" | 22" | 24" | 26" | 28" | 30" | 32" | 34" | 36" | 40" |
|----------------|---------|---------|---------|---------|---------|---------|---------|---------|---------|---------|---------|
| HEAVY | | | | | | | | | | | |
| Concert/Parade | BD-18 | BD-20 | BD-22 | BD-24 | BD-26 | BD-28 | BD-30 | BD-32 | BD-34 | BD-36 | BD-40 |
| EXTRA-HEAVY | | | | | | | | | | | |
| Drum Corps | BC-18 | BC-20 | BC-22 | BC-24 | BC-26 | BC-28 | BC-30 | BC-32 | BC-34 | BC-36 | BC-40 |
| Prices: | \$16.00 | \$18.00 | \$19.00 | \$20.00 | \$21.00 | \$22.00 | \$23.00 | \$24.00 | \$25.00 | \$26.00 | \$28.00 |

Please order by catalog number as listed above

TIMPANI HEAD WEIGHT

| Diameters: | 20" | 23" | 25" | 26" | 28" | 29" | 30" | 32" |
|---------------------|---------|---------|---------|---------|---------|---------|---------|---------|
| MEDIUM | | | | | | | | |
| Regular Collar | T-20 | T-23 | T-25 | T-26 | T-28 | T-29 | T-30 | T-32 |
| Prices: | \$19.00 | \$20.00 | \$21.00 | \$22.00 | \$24.00 | \$25.00 | \$27.00 | \$29.00 |
| New Extended Collar | T-120 | T-123 | — | T-126 | — | T-129 | — | T-132 |
| Prices: | \$21.00 | \$23.00 | — | \$26.00 | — | \$30.00 | — | \$34.00 |

Please order by catalog number as listed above

Other sizes available upon request. NOTE: In order to obtain a head to fit, measure the outside diameter of the bowl; specify for which model timpani and/or manufacturer.

HEAD REPLACEMENT LEGEND:

OR—Orchestra
 CT—Concert Drums, Tom-Toms and
 Timbale
 TA—Tambourine and Practice Pad
 TI—Timpani-Toms and Concert Toms

TO—Concert Drums and Tom-Toms
 PA—Parade Drums
 RO—Rock
 DC—Drum Corps
 S—Snare

BO—Bongo
 CO—Conga
 BD—Bass Drum—Concert and Parade
 BC—Bass Drum—Drum Corps
 T—Timpani

LUDWIG calf heads

SELECT FIRST QUALITY PROFESSIONAL CALF BATTER HEADS



| Unmounted | | Mounted | |
|------------------------------|---------|------------|---------|
| No. 599—16" for 12" shell... | \$ 9.50 | No. 599M.. | \$15.00 |
| No. 600—17" for 13" shell... | 10.25 | No. 600M.. | 15.75 |
| No. 601—18" for 14" shell... | 11.25 | No. 601M.. | 16.75 |
| No. 602—19" for 15" shell... | 12.50 | No. 602M.. | 18.00 |
| No. 603—20" for 16" shell... | 14.00 | No. 603M.. | 19.50 |
| No. 604—21" for 17" shell... | 15.25 | No. 604M.. | 20.75 |
| No. 605—22" for 18" shell... | 16.75 | No. 605M.. | 22.25 |

Heads for No. 2357 Metal Shell Expando Bongos

| | | |
|----------------------------------------|---------|--------------|
| No. 606—10" for 6" Metal Bongo..... | \$ 6.50 | Not Supplied |
| No. 607—12" for 8" Metal Bongo..... | 9.00 | Mounted |

Heads for No. 2358 Wood Shell Bongos with "Hi-Hat" Deep Collar

| | | | |
|----------------------------|---------|------------|---------|
| No. 608—14" for 6" Bongo.. | \$ 9.50 | No. 608M.. | \$15.00 |
| No. 609—16" for 8" Bongo.. | 10.00 | No. 609M.. | 15.50 |

Tucked on your
Ludwig timbales
counterhoop

| | | | |
|------------------------------|---------|------------|---------|
| No. 611—19" for 13" Timbales | \$12.25 | No. 611M.. | \$24.00 |
| No. 612—20" for 14" Timbales | 13.75 | No. 612M.. | 25.50 |

SELECT FIRST QUALITY TRANSPARENT SNARE HEADS

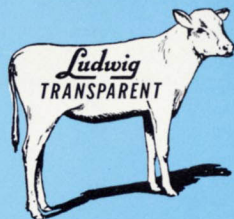

| Unmounted | | Mounted on Hoop | |
|------------------------------|---------|-----------------|---------|
| No. 650—17" for 13" shell... | \$ 8.25 | No. 650M.. | \$13.75 |
| No. 651—18" for 14" shell... | 8.75 | No. 651M.. | 14.25 |
| No. 652—19" for 15" shell... | 9.00 | No. 652M.. | 14.50 |
| No. 653—20" for 16" shell... | 9.50 | No. 653M.. | 15.00 |
| No. 654—21" for 17" shell... | 10.00 | No. 654M.. | 15.50 |
| No. 655—22" for 18" shell... | 10.50 | No. 655M.. | 16.00 |

SELECT FIRST QUALITY PROFESSIONAL ALL-WHITE BASS DRUM HEADS

| Unmounted | | Mounted on Hoop | |
|------------------------------|---------|-----------------|---------|
| No. 618—25" for 20" shell... | \$27.00 | No. 618M.. | \$35.10 |
| No. 619—27" for 22" shell... | 29.50 | No. 619M.. | 37.60 |
| No. 620—29" for 24" shell... | 31.25 | No. 620M.. | 39.35 |
| No. 621—31" for 26" shell... | 35.25 | No. 621M.. | 43.35 |
| No. 622—33" for 28" shell... | 39.00 | No. 622M.. | 47.10 |
| No. 623—35" for 30" shell... | 41.25 | No. 623M.. | 49.35 |
| No. 624—37" for 32" shell... | 44.00 | No. 624M.. | 52.10 |
| No. 625—39" for 34" shell... | 47.25 | No. 625M.. | 55.35 |
| No. 626—41" for 36" shell... | 50.25 | No. 626M.. | 58.35 |

WM. F. LUDWIG SELECTED TIMPANI HEADS

Ludwig timpani heads are carefully selected and graded under the personal supervision of Wm. F. Ludwig. Therefore, look for this trademark when you buy:

| Unmounted | | Mounted on Your Hoop | |
|------------------------------|---------|----------------------|---------|
| No. 669—29" for 23" timpani. | \$43.00 | No. 669M | \$50.50 |
| No. 671—31" for 25" timpani. | 47.25 | No. 671M | 54.75 |
| No. 672—32" for 26" timpani. | 48.25 | No. 672M | 56.75 |
| No. 674—34" for 28" timpani. | 53.50 | No. 674M | 60.00 |
| No. 675—35" for 29" timpani. | 55.75 | No. 675M | 64.25 |
| No. 676—36" for 30" timpani. | 58.00 | No. 676M | 66.50 |
| No. 677—38" for 32" timpani. | 61.00 | No. 677M | 69.75 |

NOTE: For makes other than Ludwig timpani, send your flesh hoop. If a size is desired other than standard dimensions, send either your flesh hoop or counterhoop as a pattern.

NEW CALF TIMPANI HEADS

| Unmounted | | Mounted on your Hoop | |
|-------------------------------|---------|----------------------|---------|
| No. 668—28" for 20" Timpani.. | \$41.75 | No. 668M | \$49.25 |

NEW EXTENDED CALF TIMPANI HEADS

| | | | |
|------------------------------|---------|----------|---------|
| No. 690—29" for 20" timpani. | \$44.75 | No. 690M | \$52.25 |
| No. 691—31" for 23" timpani. | 46.00 | No. 691M | 53.50 |
| No. 692—34" for 26" timpani. | 52.75 | No. 692M | 60.25 |
| No. 693—38" for 29" timpani. | 58.50 | No. 693M | 66.00 |
| No. 694—40" for 32" timpani. | 66.25 | No. 694M | 73.75 |

HEAT-SEALED PLASTIC HEAD BAGS



All Ludwig calf skin heads are heat-sealed in air-tight plastic bags to protect the tuning collar. No air may escape or enter to destroy the important tuning collar or "draw-down" of the head. This is another free service of the Ludwig Drum Co. Heads retain their collars indefinitely.

FLESH HOOP AND TUCKING PRICES

| | | |
|------------|------------------------------------------------------------------------------------|---------|
| No. P-680 | —Wood flesh hoop for snare drum, state batter or snare side and specify size | \$ 4.00 |
| No. P-680A | —Metal flesh hoop for snare drums, state size | 4.50 |
| No. 681 | —Tucking head on wood snare or batter hoop | 1.50 |
| No. 681A | —Tucking head on metal flesh hoop. | 1.75 |
| No. P-682 | —Wood flesh hoop for Bass Drum, specify size | 4.50 |
| No. 683 | —Bass drum head tucking on hoop.. | 3.60 |
| No. P-684 | —Timpani flesh hoop, steel, state size. | 9.00 |
| No. 685 | —Timpani head tucking on steel flesh hoop | 7.50 |
| No. 687 | —Ludwig Timbales cast counterhoop, 13" or 14"—specify size desired | 10.00 |

NOTE: It is best to return your timpani flesh hoop for factory mounting of new head. This guarantees perfect fit on your timpani.

fibres cases

*and covers for **MUSSER** instruments*



**MARIMBAS
VIBES
XYLOPHONES
CHIMES**

Your expensive mallet instruments need and deserve the protection offered by a line of top grade vulcanized fibre carrying cases. Each set of cases is carefully designed to provide maximum protection and ease of portability. Special construction features include: Heavy gauge vulcanized fibre used throughout. Metal reinforcement on all corners, special "shock" mountings and blocks for each individual part, special cloth roll-up divider for all removable wood and metal keyboards.

- No. M-135—Set of 2 cases for #60 Triette Marimba \$ 85.00
- No. M-141—Set of 5 cases for #75 Century Vibe. 380.00
- No. M-142—Set of 3 cases for #48 or #45 Portable Vibe 250.00
- No. M-143—Set of 4 cases for #150 Century Marimba 301.00
- No. M-144—Set of 3 cases for #30 Brentwood Marimba 261.00
- No. M-145—Single case for #20 Prep Marimba. 51.75
- No. M-146—Set of 2 cases for #50 Portable Xylophone 146.40
- No. M-147—Single case for #43 Elite Xylophone. 98.50
- No. M-148—Set of 5 cases for #250 Concert Grand Marimba 362.30
- No. M-149—Set of 3 cases for #55 Pro Vibe 210.00
- No. M-158—Set of 3 cases for #635 Chimes \$378.00

NEW VINYL FLEECE LINED COVERS FOR MUSSER MALLET INSTRUMENTS

If your mallet percussion instruments are left standing in a studio, band or orchestra room, club or at home, they need the protection of Musser's new Vinyl Fleece Lined covers. The handsome black vinyl cover will protect the keyboard from the elements and unauthorized personnel. Each cover is perfectly tailored to fit each keyboard with a 6" drop on all sides.

- No. M-160—Cover for #20 Prep Marimba \$12.50
- No. M-161—Cover for #30 Brentwood Marimba 20.00
- No. M-162—Cover for #43 Elite Xylophone 12.50
- No. M-163—Cover for #48 or #45 Portable Vibe 15.00
- No. M-164—Cover for #50 Portable Xylophone 15.00
- No. M-165—Cover for #55 Pro Vibe 20.00
- No. M-166—Cover for #60 Triette Marimba 12.50
- No. M-167—Cover for #75 Century Vibe 20.00
- No. M-168—Cover for #150 Century Marimba 25.00
- No. M-169—Cover for #250 Concert Grand Marimba 25.00



LUDWIG FIBRE CASES

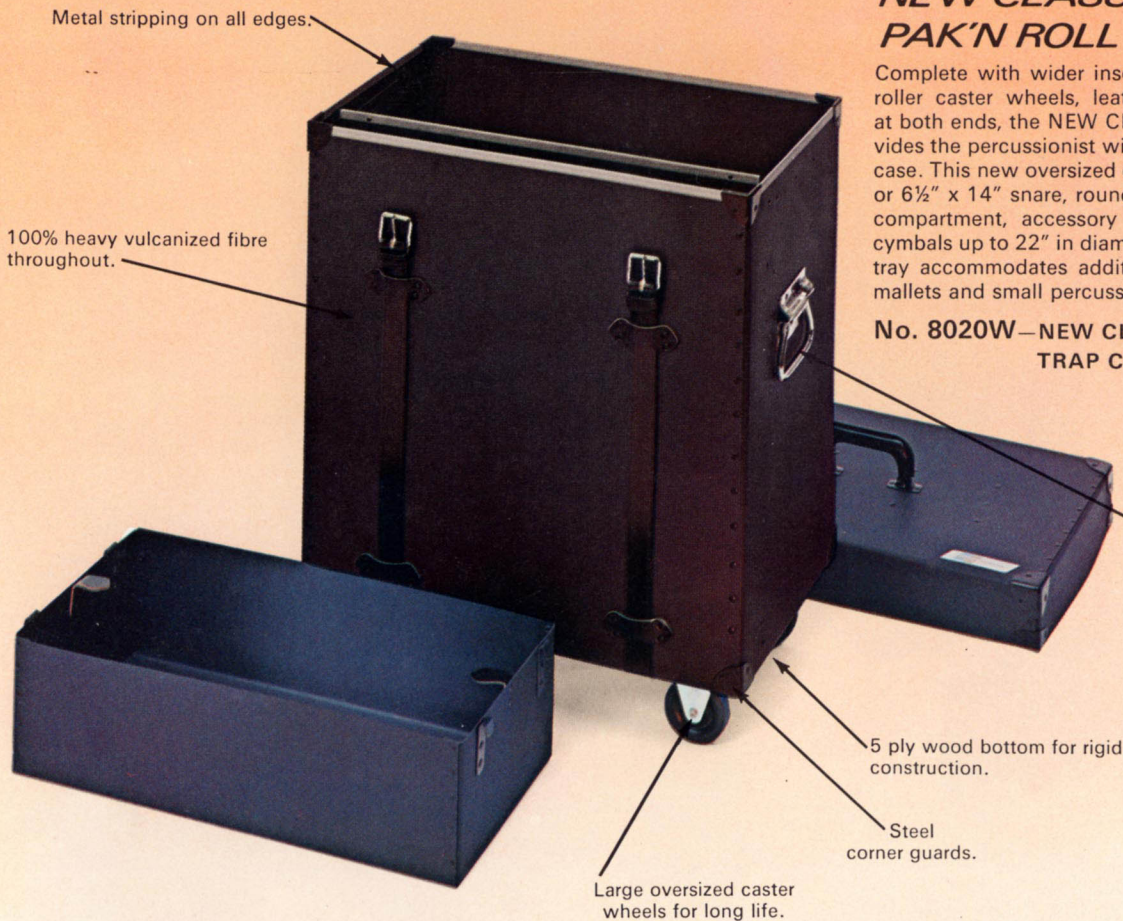

NEW CLASSIC PAK'N ROLL TRAP CASE

Complete with wider insert tray, mounted oversized heavy duty roller caster wheels, leather strap fasteners and steel handles at both ends, the NEW CLASSIC PAK'N ROLL TRAP CASE provides the percussionist with the ultimate in a carrying and porting case. This new oversized case allows for the storage of a 5" x 14" or 6½" x 14" snare, round stool seat and 10" tambourine in one compartment, accessory stands in another compartment, and cymbals up to 22" in diameter in another compartment. The wider tray accommodates additional accessory items, sticks, brushes, mallets and small percussion instrument items.

No. 8020W—NEW CLASSIC PAK'N ROLL TRAP CASE \$80.00

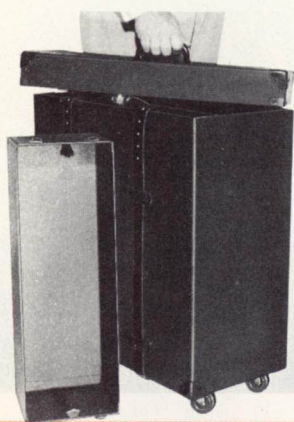

PAK'N ROLL VULCANIZED TRAP CASE

An excellent all-purpose trap case designed for the drummer on the go. Holds snare drum, stands, foot pedal, sticks, accessories and all cymbals up to 22" diameter. Large heavy duty roller casters provide easy transport of your heavy equipment. Sturdy plywood bottom.

No. 8021W—PAK'N ROLL TRAP CASE. \$76.00



SUIT CASE MODEL VULCANIZED TRAP CASE

A favorite of the traveling drummer. Trap tray over snare drum holds sticks, stands and small accessories. Adjustable compartment provides maximum protection for snare drum. Deep compartment next to snare drum is designed for pedal and bulky accessories.

No. 7840—SUIT CASE MODEL TRAP CASE . . . \$38.00

TRAP CASE TRAY WITH WHEELS

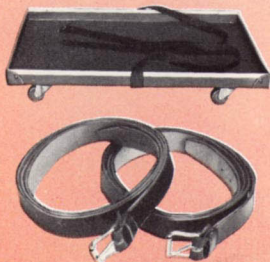

Designed to attach to the bottom of your present trap case. Simply place case on tray and fasten securely with straps supplied.

No. 8022—Tray with wheels and straps for No. 8021 TRAP CASE . . . \$18.50

No. 8023— Replacement straps for 8020W, 8021, 8021W Trap Case, per pr. \$9.50

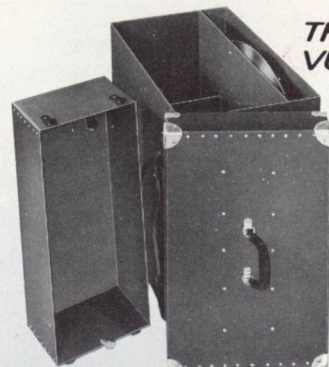

THE HOLD-ALL VULCANIZED TRAP CASE

Ludwig first designed this style of case to accommodate those large diameter cymbals. Made of sturdy vulcanized fibre with heavy-duty steel corner guards and sturdy carrying handle. Holds snare drum, cymbals, and all accessories neatly and compactly.

No. 8021—HOLD-ALL TRAP CASE . . . \$61.75



**NEW
BASS DRUM FIBRE CASES**

Ludwig's NEW BASS DRUM FIBRE CASES were designed to accommodate the following bass drums with the new curved spurs. Cases are form-fitted, rigid and mounted with heavy duty handles.

| | |
|-------------------------|----------|
| No. 6892—12" x 18"..... | \$ 36.00 |
| No. 6893—14" x 18"..... | 41.50 |
| No. 6891—12" x 20"..... | } 41.00 |
| No. 6890—14" x 20"..... | |
| No. 6992—12" x 22"..... | |
| No. 6991—14" x 22"..... | |
| No. 8676—12" x 24"..... | |
| No. 8680—14" x 24"..... | } 43.00 |
| No. 8681—14" x 26"..... | |

**REGULAR TELESCOPIC
BASS DRUM FIBRE CASES**

| | |
|-------------------------|------------|
| No. 8675— 6" x 26"..... | } \$ 43.00 |
| No. 8679— 8" x 26"..... | |
| No. 8687—10" x 26"..... | |
| No. 8677— 6" x 28"..... | |
| No. 8688—10" x 28"..... | |
| No. 8690—12" x 28"..... | } 44.00 |
| No. 8682—14" x 28"..... | |
| No. 8689—10" x 30"..... | } \$ 47.00 |
| No. 8683—14" x 30"..... | |
| No. 8684—16" x 32"..... | |
| No. 8685—16" x 34"..... | |
| No. 8686—16" x 36"..... | |
| No. 8678—18" x 40"..... | |
| | |

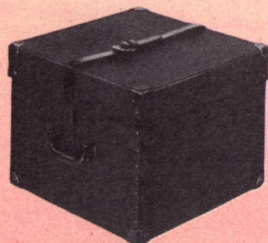

**SQUARE VULCANIZED
FIBRE CASE FOR
SUPER-SENSITIVE DRUMS**

Designed to accommodate the Super-Sensitive snare mechanisms.

| | |
|----------------------------------------------------------------------------|----------|
| No. 7154—Case for 14" diameter Super-Sensitive drums..... | \$ 18.50 |
| No. 7155—Case for 14" and 15" diameter Super-Sensitive parade drums.... | 24.50 |



**ROUND TELESCOPIC
FLAT BOTTOM
VULCANIZED FIBRE CASES**

Designed to hold the following drum sizes.

SNARE DRUM FIBRE CASES

| | |
|---------------------------------|----------|
| No. 7149—3" x 13"..... | \$ 16.00 |
| No. 7150—4" /5" /6½" x 14"..... | 17.00 |
| No. 7151—6½" x 15"..... | 18.00 |

PARADE DRUM FIBRE CASES

| | |
|-------------------------|----------|
| No. 6470—10" x 14"..... | \$ 21.00 |
| No. 6571—10" x 15"..... | 22.00 |
| No. 6671—12" x 15"..... | 23.00 |
| No. 6772—12" x 16"..... | 24.00 |
| No. 6873—12" x 17"..... | 27.00 |

TOM TOM FIBRE CASES

| | |
|------------------------------------------------------------------------|------------|
| No. 8361—8" x 12"..... | } \$ 19.00 |
| No. 8362—9" x 13"..... | |
| No. 8364—Combination case for tom toms, 8" x 12" and 9" x 13"..... | |
| No. 8464—14" x 14"..... | 36.00 |
| No. 8464—14" x 14"..... | 23.00 |
| No. 8565—16" x 16"..... | 24.50 |
| No. 8866—16" x 18"..... | 32.00 |
| No. 8588—18" x 20"..... | 40.00 |
| No. 8566—Combination case for tom toms, 8" x 12" and 14" x 14"..... | 40.00 |
| No. 8567—Combination case for tom toms, 9" x 13" and 16" x 16"..... | 41.00 |

SPECIAL FIBRE CASES

| | |
|-----------------------------------------------------|----------|
| No. 8122—Bongo case..... | \$ 19.00 |
| No. 8888—Conga or seat case..... | 32.00 |
| No. 840—Fibre case for 20" Marching Timpano..... | 55.00 |
| No. 841—Fibre case for 23" Marching Timpano..... | 63.00 |
| No. 843—Fibre case for 26" Marching Timpano..... | 72.00 |
| No. 845—Fibre case for 29" Marching Timpano..... | 81.00 |



LUDWIG is the only drum company operating its own case department—your guarantee of a perfect fit.



CONTOURA DRUM KIT CASES

Ludwig's line of CONTOURA drum kit cases have met with great acceptance from student, educator and dealer alike. Designed to provide maximum protection for drums and accessories, CONTOURA cases are molded of durable, high impact, textured acrylic and trimmed in bright satin extruded aluminum. Three heavy-duty latches and double hinges securely hold the case closed. Drum fits comfortably into top of case; separate bottom compartment holds all accessories. Lightweight CONTOURA cases are available in three interior finishes: unlined, blue felt-lined or red plush-lined.

No. 8030—UNLINED CONTOURA CASE \$22.00

No. 8031—FELT-LINED CONTOURA CASE 32.00

No. 8032—PLUSH-LINED CONTOURA CASE 35.00



MALLET AND MUSIC CASE

Ludwig introduces a handsome new case designed especially for carrying valuable sheet music, beaters and mallets. The seamless, molded, textured acrylic case provides maximum protection as well as long-lasting beauty. Smart looking hardware is plated for exceptional service. The case measures 17½" x 12" overall and has a handy pocket in the cover for storing sheet music.

No. 7156-1—MALLET AND MUSIC CASE. \$19.00



DURA-HYDE TIMPANI STICK BAG

Made of Ludwig's handsome black DURA-HYDE, this durable, new Timpani Stick Bag is designed for long-lasting protection to valuable timpani sticks when not in use. Bag hangs conveniently on the timpani during performance, in easy reach of the player. DURA-HYDE bag accommodates 4 pairs of timpani sticks.

No. 340—TIMPANI STICK BAG \$5.75



PARADE KIT CASE

A square fibre case designed for the economy 10" x 14" parade drum kit. Top protection—easy to carry.

No. 7153—10" x 14" PARADE DRUM CASE \$18.00



CONCERT KIT CASE

A quality low priced case designed for the 5" x 14" concert drum. Holds drum, stand, sticks, books and small accessories.

No. 7152—CONCERT KIT CASE \$17.00

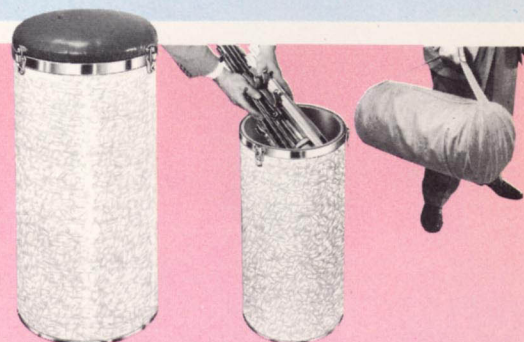

THE EXCLUSIVE LUDWIG SEAT-CASE

The Ludwig SEAT-CASE performs a twofold function. It is both an attractive seat which is available in finishes to match your outfit as well as a case to hold all your stands and accessories. Seat is padded and covered with beautiful black leatherette. Supplied with mackintosh zipper cover at no additional cost.

No. 1027—DRUMMERS SEAT-CASE in choice of pearl finishes. . . . \$88.00



**DURA-HYDE
DRUM COVERS**

Handsome DURA-HYDE covers, made of heavy long-wearing, weather resistant, fabric-backed vinyl, offer the finest protection at moderate cost. These popular covers are supplied in striking jet black leather tone and are easy to clean to retain their "new look" for years. Exclusive features include heavy-duty zippers, double strength handles and bumper bindings. Available individually or in sets.

SNARE DRUM COVERS

- No. 170—3" x 13" . . .
- No. 171—4" x 14" . . .
- No. 172—5" x 14" . . . } \$14.75
- No. 173—6½" x 14" . . .
- No. 174—6½" x 15" . . .

TOM TOM COVERS

- No. 175— 8" x 12" . . . } \$14.00
- No. 176— 9" x 13" . . .
- No. 177—14" x 14" . . . \$15.50
- No. 178—16" x 16" . . . 16.25
- No. 179—16" x 18" . . . 17.50
- No. 180—18" x 20" . . . 21.50

**PARADE DRUM
COVERS**

- No. 270—10" x 14" . . . } \$15.00
- No. 271—10" x 15" . . .
- No. 272—12" x 15" . . . } \$15.50
- No. 273—12" x 16" . . .
- No. 274—12" x 17" . . . \$16.25

**SCOTCH BASS
DRUM COVERS**

- No. 275—16" x 26" . . . \$27.00
- No. 276—10" x 26" . . . 25.75
- No. 277— 8" x 28" . . .
- No. 278—10" x 28" . . . } \$27.00
- No. 279—10" x 30" . . .

**DANCE BASS DRUM
COVERS**

- No. 181—16" x 24" . . . \$24.25
- No. 182—12" x 18" . . . 21.75
- No. 183—14" x 18" . . . } \$23.00
- No. 184—12" x 20" . . .
- No. 185—14" x 20" . . .
- No. 186—12" x 22" . . . } \$23.75
- No. 187—14" x 22" . . .
- No. 188—14" x 24" . . .
- No. 189—14" x 26" . . . \$25.75

**CONCERT BASS
DRUM COVERS**

- No. 280—14" x 28" . . . \$27.00
- No. 281—14" x 30" . . . 28.75
- No. 282—16" x 32" . . . 30.00
- No. 283—16" x 34" . . . 32.00
- No. 284—16" x 36" . . . 33.75
- No. 285—18" x 40" . . . 38.75

DRUM COVER SETS

- No. 160-1— 5" x 14" . . . } \$67.50
- 8" x 12" . . .
- 14" x 14" . . .
- 14" x 20" . . .
- No. 161-1— 5" x 14" . . . } \$68.25
- 9" x 13" . . .
- 16" x 16" . . .
- 14" x 22" . . .
- No. 162-1— 5" x 14" . . . } \$82.00
- 8" x 12" . . .
- 9" x 13" . . .
- 16" x 16" . . .
- 14" x 22" . . .
- No. 286 —Throne Seat
Cover . . . \$24.50
- No. 172-1— 5" x 14" . . . } \$16.50
- Super-Sens.
Cover . . .
- No. 173-1—6½" x 14" . . . } \$16.50
- Super-Sens.
Cover . . .

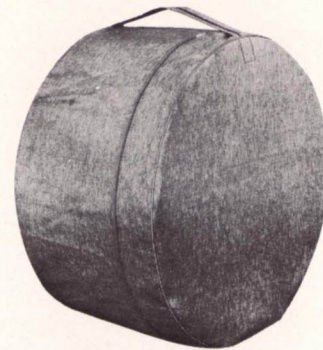

MACKINTOSH ZIPPER COVERS

Ludwig mackintosh covers are made from the finest materials available. They are top quality water repellent, fleece-lined covers offering years of protection and service. Easy zipper action provides fast packing of drums.

BASS DRUM COVERS

- No. 151—12" x 18"
- No. 152—14" x 18" } \$15.50
- No. 154—12" x 20"
- No. 155—14" x 20"
- No. 156—12" x 22" } \$16.00
- No. 157—14" x 22"
- No. 54 —14" x 24" \$18.25
- No. 56 —14" x 26" 20.00
- No. 49 —14" x 28" 22.25
- No. 50 —14" x 30" 24.00
- No. 52 —16" x 32" 26.75
- No. 58 —16" x 34" 28.00
- No. 60 —16" x 36" 30.00
- No. 59 —18" x 40" 32.25
- No. 48 —16" x 24" 18.25

SNARE DRUM COVERS

- No. 33 —3" x 13" \$8.75
- No. 34 —4" x 14"
- No. 30 —5½" x 14" } \$9.25
- No. 30A—5" x 14"
- No. 31 —6½" x 14"
- No. 32 —6½" x 15" } \$9.75
- No. 32A—8" x 15"

TOM TOM COVERS

- No. 43— 8" x 12" \$ 9.00
- No. 35— 9" x 13" 9.25
- No. 51—14" x 14" 10.00
- No. 29—16" x 16" 11.25
- No. 64—16" x 18" 12.50
- No. 44—18" x 20" 13.50

SCOTCH BASS DRUM COVERS

- No. 53— 8" x 26" \$18.25
- No. 47—10" x 26" 19.00
- No. 61— 8" x 28" 19.75
- No. 62—10" x 28" 20.75
- No. 66—10" x 30" 21.50

PARADE DRUM COVERS

- No. 38—10" x 14" \$ 9.25
- No. 39—10" x 15" } 10.00
- No. 40—12" x 15"
- No. 41—12" x 16" 10.25
- No. 42—12" x 17" 10.75
- No. 55—12" x 18" 15.00

Ludwig

EDUCATIONAL SERVICES

Ludwig Industries has always played an active and vital role in the area of music education. The Ludwig Educational Department is constantly expanding its program of services for the student, music educator and professional musician. Today, this program is the most comprehensive in the entire music industry. It is designed to fill the needs of the rapidly expanding percussion field—covering every aspect of the modern concept . . . "Total Percussion."



Ludwig

CLINIC PROGRAM—

provides educational institutions and Ludwig dealers with a booklet of information about its talent roster, their qualifications and engagement arrangements. The Clinic Program covers rudimental, marching, concert, ensemble, jazz, rock, Latin-American and mallet percussion by recognized experts in each area. A special inquiry form is included to assist you in planning a percussion clinic.

Ludwig pioneered the manufacturer sponsored clinic program in the late 1920's. Ludwig's talent roster features these outstanding percussionists:

| | | |
|-----------------------------------------------|---------------------|---------------|
| FRANK ARSENAULT | TOM BROWN | GARY BURTON |
| BOBBY CHRISTIAN | NORM CHRISTIAN | MARV DAHLGREN |
| THOMAS L. DAVIS | GEORGE GABER | SOL GUBIN |
| DICK GERLACH | GARY BURTON QUARTET | ROY HAYNES |
| MITCH MARKOVICH | JOE MORELLO | AL PAYSON |
| JIM SEWREY | DICK SCHORY | DUANE THAMM |
| ED THIGPEN | BOB TILLES | KEN WATSON |
| DICK SCHORY and the PERCUSSION POPS ORCHESTRA | | |

They are available to local sponsors of clinic workshops, festivals and concerts. Take advantage of this outstanding reservoir of talent by writing for available dates of the artist of your choice. Send for complete details and fees; simply address your request to Clinic Program, Educational Department, Ludwig Industries.



THE LUDWIG DRUMMER—

magazine is devoted solely to the advancement of the art of percussion. It is the only publication distributed worldwide, written by and for the percussionist. Published twice yearly; copies may be obtained from your local Ludwig dealer or by writing directly to Ludwig Industries, Educational Department.

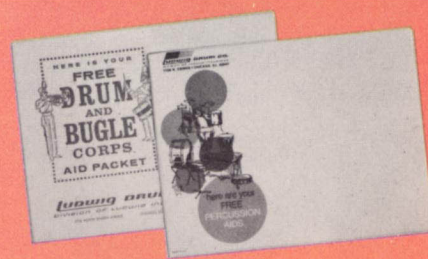

PERCUSSION AID PACKS—

are available to schools, teachers, dealers and individuals, covering all phases of percussion. Two separate packs are now available, FREE, for your classes, meetings, clinics or personal use. Specify either or both the (1) GENERAL PERCUSSION AID PACK or (2) THE DRUM AND BUGLE AID PACK. Packs may be obtained from your local Ludwig dealer or by writing directly to Ludwig Industries, Educational Department.



PUBLICATION DEPARTMENT

To provide the percussion world with the finest publications, Ludwig Industries is constantly adding to and up-dating its performance and educational materials. Check with your local music dealer for the new materials from Ludwig Industries. A publications catalog may be obtained from your local Ludwig dealer or by writing directly to Ludwig Industries, Publications Department.

HOW TO ORDER

Ludwig products are sold by authorized music dealers everywhere and are only available through these dealers. WHEN ORDERING, PLEASE GIVE CATALOG NUMBER AND COMPLETE INFORMATION ON SIZE, COLOR, FINISH AND ANY SPECIAL INSTRUCTIONS. PLEASE GIVE SHIPPING INSTRUCTIONS PLAINLY.

HOLDERS will be mounted unless otherwise specified. Drums will be supplied with the new Ludwig Weather Master plastic heads *unless* otherwise specified. For special CUSTOM lacquer colors, submit sample of color. All special colors and models accepted *only* on a non-returnable and non-cancellable basis. All hardware on Ludwig Drums is chrome plated.

LUDWIG

DRUM COMPANY

DIVISION OF
LUDWIG INDUSTRIES
1728 No. Damen Ave.
Chicago, Illinois 60647

INDEX

| | Page | Page | |
|------------------------------------------------|-----------------------------------------------|-------------------------------------------------------------|---------------------------------------|
| A Accessory Instruments | 93, 94, 95 | Marching Congas | 42, 43 |
| Acrolite Beaters | 88, 89 | Marching Timbales, Holders | 42 |
| Acrolite Drum | 22 | Marching Timpani | 42 |
| Acrolite Drum Kits | 30, 31 | Marimbas | 68, 69 |
| Afuiche (Cabasa) | 65 | Multi-Angle Carrying Hook | 41 |
| Agogo Bells | 64 | Multi-Mount Carrying Holder | 42 |
| All-metal Parade Drums | 44, 45 | Music Holder, Bell Lyra | 73 |
| | | Music Rack | 77 |
| B Bass Drums | 36, 37, 38, 40, 44, 45, 46, 47, 48, 49, 50 | Musser Cases and Covers | 99 |
| Bass Drum Anchor | 36 | Musser Mallets and Accessories | 76, 77 |
| Bass Drum Carriage | 39 | N Nylon Tip Sticks | 86, 87 |
| Bass Drum Covers | 39 | O Orchestra Bells | 74 |
| Bass Drum Cymbal Holder | 38 | Orchestra Bell Stand | 77 |
| Bass Drum Impact Pad | 36 | Orchestral Whistle | 94 |
| Bass Drum Muffler | 36 | P Parade Drums | 26, 44, 45, 46, 47, 48, 49, 50, 51 |
| Bass Drum Stand | 38 | Pedals | 15, 18 |
| Bass Drum Tilter Stand | 39 | Performance-Practice Duo | 29 |
| Baton (Drum Major's Signal) | 41 | Piccolo Snare Drum | 25 |
| Beaters and Mallets | 88, 89 | Piccolo Wood Block | 95 |
| Bell Lyras and Accessories | 72, 73 | Plastic Heads | 96, 97 |
| Bird Whistle | 94 | Pop Gun | 95 |
| Bongo Drums | 43, 63 | Poto-Seat | 16 |
| Bongo Drums (Marching) | 42, 43 | Practice Pads, Holders, Stands | 90, 91 |
| Bongo Hoop Mount Holder | 63 | R Ratchet | 94 |
| Brushes | 85 | Ruff-Kote | 86 |
| C Cases | 20, 100, 101, 102, 103 | S Scotch Bass Drums | 44, 45, 46, 47, 48, 49, 50 |
| Cases (Musser) | 99 | Scotch Bass Drum, Thin-Line | 40 |
| Castanets | 93 | Siren Horn | 94 |
| Celeste, Covers | 75 | Siren Whistle | 94 |
| Chimes, Covers | 74 | Slapstick | 94 |
| Claves | 65 | Sleigh Bells | 94 |
| Concert Bass Drums | 38 | Slings | 41 |
| Concert Bass Drum Tilter Stand | 39 | Snare Drum Quartet | 26 |
| Concert Tom Toms and Stands | 27 | Snare Drums | 19, 20, 21, 22, 23, 24, 25, 26 |
| Conga Drums | 62 | Snare Drum Stands | 16, 17, 18 |
| Covers | 39, 84, 99, 100, 101, 102, 103 | Snares | 21, 44, 45, 46, 47 |
| Covers (Musser) | 99 | Sock Pedals | 16, 17 |
| Cow Bells | 64 | Song Whistle | 94 |
| Chromatic Gongs | 83 | Special Effects Instruments | 94, 95 |
| Cymbals | 78, 79, 80, 81 | Spur Stop | 36 |
| Cymbal Accessories | 84 | Spurs | 36 |
| Cymbal Holders, Grips, Handles | 84, 91 | Sticks (Bass Drum) | 88, 89 |
| Cymbal Polish | 84 | Sticks (Snare Drum) | 86, 87 |
| Cymbal Pouch | 84 | Sticks (Tenor Drums) | 89 |
| Cymbal Stands | 16, 17 | Sticks (Timbales) | 63 |
| D Dinner Gongs | 82 | Sticks (Timp-Tom Trio) | 89 |
| Drum Kits | 29, 30, 31, 32, 33 | Sticks (Timpani) | 88 |
| Drum Major's Signal Baton | 41 | Stools | 16, 17 |
| Drum Outfits | 4, 5, 6, 7, 8, 9, 10, 11, 12, 13, 14 | Street Drums 26, 44, 45, 46, 47, 48, 49, 50, 51 | 51 |
| Drum Seats | 16, 17 | Swing Flags | 41 |
| Drum Stands | 16, 17, 18 | T Tambourines | 92, 93 |
| Drum Stand Extension Tube | 17 | Temple Blocks and Stands | 27 |
| Dura-Hyde Covers | 20, 103 | Tenor Drum Holder | 41 |
| E Extension Tube (Drum Stand) | 17 | Tenor Drums | 44, 45, 46, 47, 48, 49, 50 |
| F Field Drums | 26, 44, 45, 46, 47, 48, 49, 50, 51 | Thin-Line Scotch Bass Drum | 40 |
| Finger Cymbals | 82 | Throne | 16, 17, 102 |
| Flags (Swing) | 41 | Timbale Cow Bell | 64 |
| G Glockenspiel, Bell Lyra | 72, 73 | Timbales | 63 |
| Gongs, Gong Plays, Stands | 82 | Timbale-Cow Bell Holder | 63 |
| Gong Covers | 84 | Timp-Tom Trio Cases | 42, 43 |
| Gong Mallets | 84 | Timpani | 43, 54, 55, 56, 57, 58, 59, 60 |
| Guiro | 65 | Timpani Accessories | 61 |
| H Heads, Calf and Plastic | 96, 97, 98 | Timpani, Machine | 60 |
| Head Lettering | 39 | Timpani, Marching | 42 |
| Hi-Hat Sock Pedals | 16, 17 | Timpani Trunks and Covers | 61 |
| Hi-Hat Stands | 16, 17 | Timpani Tuning Gauges | 61 |
| Hi-Stepper | 41 | Tom Toms | 34, 35 |
| J Junior Percussionists Kits | 28, 29 | Tom Tom Shell Mount Holders | 34 |
| K Kits | 28, 29, 30, 31, 32, 33 | Tuning Forks and Bars | 77 |
| Ka-Me-So | 65 | Trap Table | 93 |
| L Lamo Sticks | 86, 87 | Trap Tree | 95 |
| Latin-American Instruments | 43, 62, 63, 64, 65 | Triangles | 92 |
| Leg Rests | 51 | V Verti-Holder | 41 |
| M Mallets (Gongs) | 84 | Vibes | 66, 67 |
| Maracas | 65 | Vibra-Slaps | 65 |
| Marching Accessories | 41 | W Whistles (Bird, Orchestral, Siren, Song) | 94 |
| Marching Bongos, Holders | 42, 43 | Wire Brushes | 85 |
| | | Wood Blocks | 93 |
| | | X Xylophones | 70, 71 |

LUDWIG PEARL FINISHES

are the product of one of the world's leading chemical manufacturers. They are the finest available and will add extra life and lasting beauty to your drums. The hard surface will not scratch, peel or chip. Ludwig now offers the new Multi-Sparkle* pearl, combining any two of the 6 sparkling finishes. Multi-Sparkle* pearl is another Ludwig quality feature available at no extra cost. When ordering—specify outer color first, inner color second.

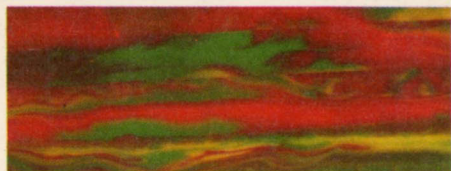

CITRUS MOD No. 8015

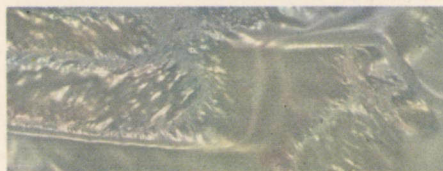

WHITE MARINE No. 2005

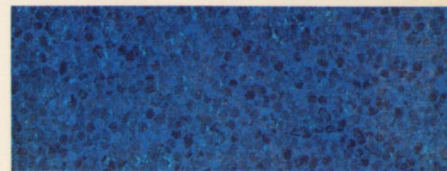

SPARKLE BLUE No. 2001



MOD ORANGE No. 2008

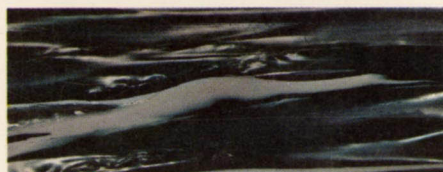

OYSTER BLACK No. 8025

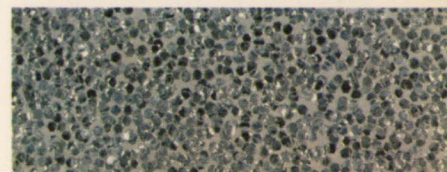

SPARKLE SILVER No. 2003



PSYCHEDELIC RED No. 2010



SKY BLUE No. 2011

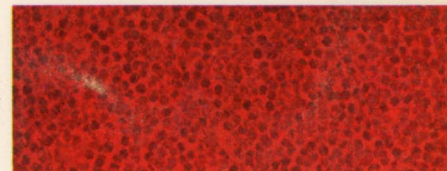

SPARKLE RED No. 2000



BLACK PANTHER No. 8019



OYSTER BLUE No. 8024

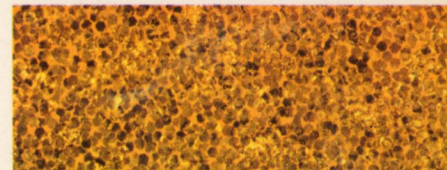

SPARKLE GOLD No. 2002



BLACK DIAMOND No. 2006

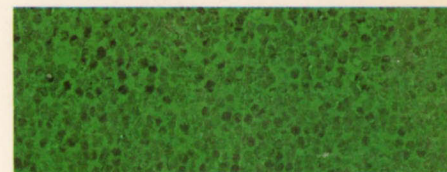

SPARKLE GREEN No. 2004

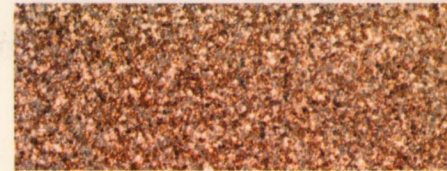

PINK CHAMPAGNE No. 2028

LUDWIG DRUM CO.

DIVISION OF LUDWIG INDUSTRIES

1728 N. Damen Ave., Chicago, Ill. 60647